

Natural Products

General Catalogue 2018

L'ANTIC COLONIAL

General Catalogue 2018

“You must look ahead in order
to move forward.
You can only make progress
when you think big”

“Sólo es posible avanzar cuando se mira lejos.
Solo cabe progresar cuando se piensa en grande”

“Regarder au loin pour mieux avancer.
En visant haut on ne peut que progresser”

José Ortega y Gasset





The Global Compact

The Global Compact is a voluntary initiative via which L'ANTIC COLONIAL S.A. and other participating companies undertake to align their operations and strategies with ten universally accepted principles in the areas of human rights, labour, the environment and anti-corruption. In terms of the number of participants, with six thousand in over 135 countries, the Global Compact is the world's largest corporate citizenship initiative. It is a framework for action aimed at boosting the social legitimacy of corporations and markets. Those companies that adhere to the Global Compact share the conviction that business practices based on universal principles contribute to building a more stable, equitable and inclusive global market that promotes more prosperous societies.

Businesses, trade and investment are basic cornerstones in ensuring peace and prosperity. However, in many areas, business is frequently associated with serious dilemmas such as exploitation, corruption, inequality and obstacles that hinder innovations and entrepreneurialism. Corporate social responsibility builds trust and social capital, while contributing to development and sustainable markets.

El Pacto Mundial es una iniciativa voluntaria, en la cual L'ANTIC COLONIAL S.A. junto a las demás empresas participantes se comprometen a alinear sus estrategias y operaciones con diez principios universalmente aceptados en cuatro áreas temáticas: derechos humanos, estándares laborales, medio ambiente y anti-corrupción. Por su número de participantes, seis mil en más de 135 países, el Pacto Mundial es la iniciativa de ciudadanía corporativa más grande del mundo. El Pacto es un marco de acción encaminado a la construcción de la legitimación social de las corporaciones y los mercados. Aquellas empresas que se adhieren al Pacto Mundial comparten la convicción de que las prácticas empresariales basadas en principios universales contribuyen a la construcción de un mercado global más estable, equitativo e incluyente que fomentan sociedades más prósperas.

Las empresas, el comercio y la inversión son pilares esenciales para la paz y prosperidad. Pero en muchas áreas las empresas están ligadas a serios dilemas, como pueden ser la explotación, la corrupción, la inequidad y otras barreras que frenan la innovación y el espíritu empresarial. Las acciones empresariales responsables construyen conanza y capital social, al mismo tiempo que contribuyen al desarrollo y mercados sustentables.

Le Pacte Mondial est une initiative à caractère facultatif dans le cadre de laquelle L'ANTIC COLONIAL S.A. et les autres entreprises participantes s'engagent à aligner leurs stratégies et opérations sur dix principes universellement admis dans quatre domaines thématiques : droits de l'homme, normes du travail, environnement et lutte contre la corruption. Le nombre de ses participants, six milles dans plus de 135 pays, fait du Pacte Mondial l'initiative de citoyenneté corporative la plus importante du monde. Le Pacte est un cadre d'action visant à la construction de la légitimation sociale des entreprises et des marchés. Les entreprises qui adhèrent au Pacte Mondial partagent la conviction que les pratiques commerciales et industrielles fondées sur des principes universels contribuent à la construction d'un marché global plus stable, équitable et intégrant une plus grande prospérité des sociétés.

Les entreprises, le commerce et les activités d'investissement constituent des piliers essentiels de la paix et de la prospérité. Mais les entreprises sont confrontées à de grands dilemmes dans de nombreux domaines, comme par exemple l'exploitation, la corruption, l'injustice et d'autres barrières qui freinent l'innovation et l'esprit d'entreprise. Les actions des chefs d'entreprise responsables développent la conance et le capital social, tout en contribuant au bien-être et à des marchés plus durables.

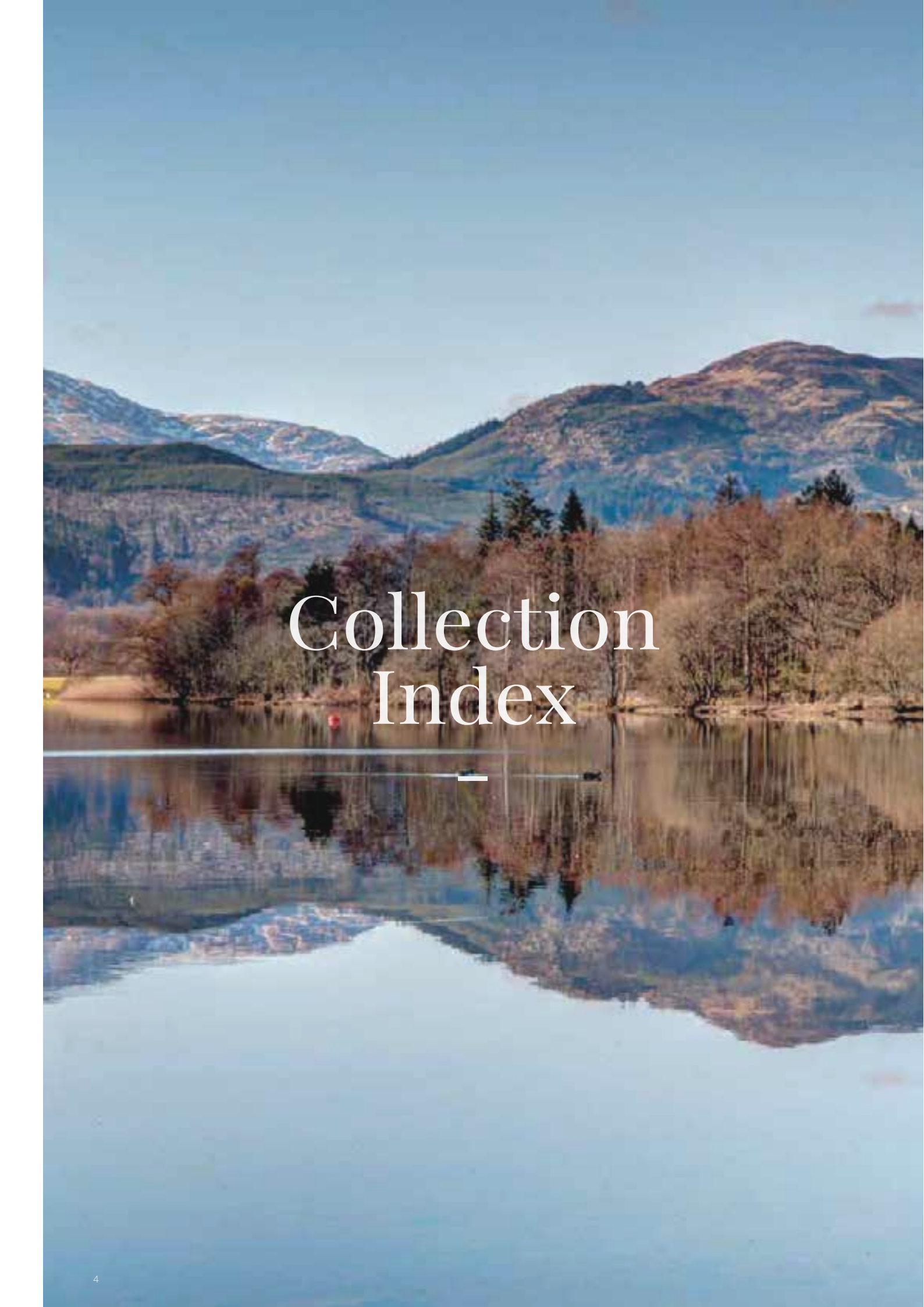

Collection Index

Índice Colecciones / Index Collectionner



01 Natural Stone

page / página / page 10



02 Bathrooms

page / página / page 132



03 Mosaics

page / página / page 254



04 Ceramic Tiles

page / página / page 376



05 Natural Wood

page / página / page 414



06 Outdoor Decking

page / página / page 534



07 Laminate Flooring

page / página / page 542



08 Linkfloor

page / página / page 604

Product Index / Índice Productos / Index Des Produits

A					
Advance 1L Blanco	473	Blanco Almeria Anticato	26	Downtown Clear	451
Advance 1L Marron	472	Blanco Calacatta Pulido	110	Downtown Grey Payne	450
Advance 1L Natural	473	Blanco Carrara Classico	28	Downtown Neutral	451
Advance 1L Warm Oak	472	Blanco Carrara Pulido	28	DQS Black	120
Advance Premium 1L Albany	476	Blue Sandstone Classico	79	DQS Grey	120
Advance Premium 1L Auckland	476	Bombay Natural Home	85	DQS White	121
Aichi Browns	272	Bombay Pulido	85	Dream Mix Whites	306
Aichi Greys	272	Bordura Bisel Blanco	404	Dream White	306
Aichi Mix Wood	272	Boston	171	Duomo Plus	140
Air Black	346	Buddha	139	E	
Air Dots Black	346	C		Eden 1L Brown	480
Air Dots Black Matt	346	Calgary Classico	64	Eden 1L Camel	481
Air Dots White	346	Calpe Black	408	Eden 1L Laguna	484
Air Dots White Matt	346	Calpe Blanco	408	Eden 1L Marengo	485
Air Hexagon Black	347	Calpe Concrete	409	Eden 1L Natural	482
Air Hexagon Black Matt	347	Calpe Nieve	409	Eden 1L Sand	483
Air Hexagon White	347	Calpe Seagreen	410	Eden 1L Venice	484
Air Hexagon White Matt	347	Calpe Warmgrey	410	Eden 1L Wenge	480
Air White	346	Capadocia Sand Home	30	Eden 1L White	482
Airslate Bombay	92	Capuccino Grey Classico	37	Eden Texture 1L Almond	496
Airslate Delhi	93	Capuccino Grey Pulido	37	Eden Texture 1L Cinamon	496
Airslate Forest	94	Capuccino Pulido	34	Eden Texture 1L Nut	497
Airslate Graphite	95	Capuccino Sand Home	34	Edition Rectangular Gold	302
Airslate Kashmir	95	Caspian Grey Pulido	42	Edition Rectangular Grey	302
Airslate Kathmandu	93	Chennai White Flamed Home	72	Edition Rectangular White	302
Airslate Metal	94	Chevron Ceniza	447	Effect Square Black	312
Airslate Patna	92	Chevron Cognac	447	Effect Square Caramel	312
Amsterdam 3D Hexagon Beige	56	Chevron Tobacco	446	Effect Square Silver	312
Amsterdam 3D Hexagon Grey	58	Chevron Vulcano	446	Effect Square White	312
Amsterdam 3D Hexagon White	54	Classic Ebano Luxor	439	Elements Mini Pattern Water	340
Amsterdam Beige	56	Classic Espiga Natura	438	Elements Mini Pattern Wind	340
Amsterdam Grey	58	Classic Espiga Yute	438	Elements Pattern Earth	340
Amsterdam Grey Sand	60	Clean and Green Active 0,5 L Lam.	600	Elements Pattern Mineral	340
Amsterdam Hexagon Beige	57	Clean and Green Active 0,5 L Linkfloor	678	Elements Pattern Water	340
Amsterdam Hexagon Grey	59	Clean and Green Active 0,5 L Parquet	527	Elements Pattern Wind	340
Amsterdam Hexagon White	55	Clean and Green Aqua Oil 1L	527	Elite Bhutan Copper	262
Amsterdam White	54	Cola Blanca 750 Gr	528	Elite Bhutan Silver	262
Ancient Bath	265	Colors Aluminium Chocolate	354	Elite Brick Ariana	264
Ancient Earth	265	Colors Aluminium Crimson	355	Elite Brick Creams	264
Aqua Blue	301	Colors Aluminium Forest	354	Elite Brick Silver Wood	264
Aqua Green	301	Colors Aluminium Jean	354	Elite Brick Whites	264
Aqua Grey	301	Colors Aluminium Nebolous	355	Elite Capuccino Texture - Pul.	264
Arabia Gold	309	Colors Aluminium Olive	354	Elite Even Burma	262
Arabia Mix Blue Silver	309	Colors Aluminium Pepper	354	Elite Even Crema Grecia	262
Arabia Silver	309	Colors Aluminium Space	354	Elite Lava Stone Brick Gold	263
Arabia Sun	309	Compatible USA	149	Elite Lava Stone Brick Silver	263
Arctic White Classico	29	Conjunto Karon Circle	180	Elite Lava Stone Gold	263
Arctic White Pulido	29	Conjunto Karon Circle Structure	182	Elite Lava Stone Mix Gold Silver	263
Armour Black	307	Conjunto Karon Oval	180	Elite Lava Stone Mix Gold White	263
Armour Caramel	307	Constellation Chevron Brown	281	Elite Lava Stone Silver	262
Art Berlin	341	Constellation Chevron White	281	Embellecedor Lavabo	149
Art New York	341	Constellation Regular Brown	281	Embellecedores Piedra	157
Art Roma	341	Constellation Regular White	281	Encimera 110x52,5x2cm	160
Artisan 1L Coconut	468	Core	145	Encimera 160x60x2cm	161
Artisan 1L Linen	469	Cream Aged Anticato	67	Encimera 80x52,5x2cm	160
Artisan 1L Wild	468	Crema Grecia Anticato	32	Encimera Blanco Carrara Tetris L	162
Artisan 1L Woven	469	Crema Grecia Classico	32	Encimera Blanco Carrara+Lav Form 110	162
Aspen White Pulido	110	Crema Grecia Pulido	33	Encimera Blanco Carrara+Lav Form 80	163
Aura Hexagon Creams	337	D		Encimera Faldon MLx52,5x10cm	161
Aura Hexagon Whites	337	Dados Blue	304	Endless 1L Broadway	590
Authentic 1L Anthracite	513	Dados Earth	304	Endless 1L Brooklyn	591
Authentic 1L Bronze	513	Dados Metal	304	Endless 1L Long Island	591
Authentic 1L Chrome	512	Dados Pearl Cream	304	Endless 1L Queens	590
Authentic 1L Pure	512	Delhi Natural Home	86	Essence	152
Azrama Primitive Vanity	214	Delhi Pulido	86	Essential Basket Thassos	268
Azrama Vanity Doors	215	Denia Black	408	Essential Chess Silver Wood	268
Azrama Vanity Double	215	Denia Blanco	408	Essential Chess Thassos	268
Azrama Vanity Single	214	Denia Concrete	409	Essential Diamond Persian White	269
		Denia Nieve	409	Essential Diamond Silver Wood	269
		Denia Seagreen	410	Essential Flag Thassos	268
		Denia Warmgrey	410	Essential Hexagon Carrara Pulido	269
		Desert Sandstone Classico	78	Essential Hexagon Persian White	269
		Diverse Black	326	Essential Hexagon Silver Wood	269
		Diverse Grey	326	Essential Mini Brick Persian White	268
		Diverse White	326	Essential Mini Brick Silver Wood	269
		Downtown Black Amber	450	Essential Stripes Silver Wood	268

Product Index / Índice Productos / Index Des Produits

Eternity Cream	330	Glacier Moon Metallic Cremas	296	Harmony Strip Gold	311
Eternity Emperador	330	Glacier Moon Metallic White	296	Harmony Strip Silver	311
Eternity Grey	330	Glaze Denim Bottle Dark	300	Hexcube Black	297
Eternity Mini Strip Cream	330	Glaze Denim Bottle Light	300	Hexcube Blue	297
Eternity Mini Strip Emperador	330	Glaze Denim Rhombus Dark	300	Hpa 180 21 Kg	528
Eternity Mini Strip Grey	330	Glaze Denim Rhombus Light	300		
Eternity Mini Strip White	331	Glaze Dots Beiges Matt	300	I	
Eternity White	331	Glaze Dots Greys / Black Matt	299	Ibiza Concrete	400
Evoke Black	310	Glaze Dots Greys Matt	299	Ibiza Concrete Gloss	401
Evoke Caramel	310	Glaze Dots Whites Matt	300	Ibiza Dark	400
Evoke Form Black	310	Glaze Hexagon Beiges Matt	299	Ibiza Dark Gloss	401
Evoke Form Caramel	310	Glaze Hexagon Greys / Black Matt	299	Ibiza Grey	400
Evoke Form Silver	310	Glaze Hexagon Greys Matt	299	Ibiza Grey Gloss	401
Evoke Silver	310	Glaze Hexagon Whites Matt	299	Ibiza Snow	400
		Glaze Micro Brick Black	298	Ibiza Snow Gloss	401
F		Glaze Micro Brick Grey	298	Ibiza Steel	400
Faces	197	Glaze Micro Brick White	298	Ibiza Steel Gloss	401
Faces Bañera	197	Glaze Mini Hexagon Black	298	Ibiza White	400
Faces Espejo Horizontal	198	Glaze Mini Hexagon Grey	298	Ibiza White Gloss	401
Faces Espejo Vertical	198	Glaze Mini Hexagon White	298	Imperia Bhutan Mirror	324
Faces H1 Blanco	390	Globe Brick Bhutan	99	Imperia Caramel	325
Faces H1 Blanco	391	Globe Brick Blanco Almeria	99	Imperia Greys	325
Faces H1 Negro	390	Globe Brick Bombay	99	Imperia Mix Silver Blacks	325
Faces H1 Negro	391	Globe Brick Delhi	98	Imperia Mix Silver Blue Blacks	325
Faces H2 Blanco	390	Globe Brick Delhi	98	Imperia Mix Silver Greys	324
Faces H2 Negro	390	Globe Brick Indira	98	Imperia Mix Silver White	324
Faces H4 Blanco	390	Globe Brick Indira	98	Imperia Nepal Bronze	324
Faces H4 Blanco	391	Globe Brick Lhasa	100	Imperia Onix Golden	324
Faces Mural	196	Globe Brick Nepal	98	Imperia White	324
Faces S1 Blanco	392	Globe Castle Burma	101	Imprimacion 99 (25 L)	528
Faces S1 Negro	392	Globe Corner Blanco Almeria	99		
Faces S3 Blanco	392	Globe Corner Brick Bhutan	99	J	
Faces S3 Negro	392	Globe Corner Brick Bombay	99	Javea Black	408
Faces S3 Oro	393	Globe Corner Brick Indira	98	Javea Blanco	408
Faces S3 Plata	393	Globe Corner Brick Lhasa	100	Javea Concrete	409
Faces S4 Blanco	392	Globe Corner Brick Nepal	98	Javea Nieve	409
Faces S4 Negro	392	Globe Corner Stick Bhutan	100	Javea Seagreen	410
Faces S4 Oro	393	Globe Corner Stick Mix Nepal Bhutan	101	Javea Warmgrey	410
Faces S4 Plata	393	Globe Corner Stick Mix Nepal Shannan	101	Karon Circle	178
Faces Stand	196	Globe Corner Stick Nepal	100	Karon Circle Countertop	179
Fidji Natural Home	87	Globe Stick Bhutan	100	Karon Circle Countertop Tower 90	181
Fila Cleaner 1L	124	Globe Stick Mix Nepal Bhutan	101	Karon Oval	178
Fila Deterdek 1L	124	Globe Stick Mix Nepal Shannan	101	Karon Oval Countertop	179
Fila Fob 1L	124	Globe Stick Nepal	100	Karon Oval Countertop Tower 90	181
Fila Hp98 1L	124	Globe Wall Bhutan	102	Kathmandu Natural Home	88
Fila Hydrorep 1L	124	Globe Wall Burma	103	Kathmandu Pulido	88
Fila Longlife 1L	124	Globe Wall Nepal	102	Kayak Beige Classico	31
Fila Matt 1L	124	Globe Wall Shannan	103	Kayak Beige Pulido	31
Fila Ps87 1L	124	Globe Wall White	102	Khoa	156
Fila Stone Plus 1L	124	Gravity Aluminium 3D Hexagon Gold	357	Kit Mantenimiento Highend Baths	124
Fila Wet 1L	124	Gravity Aluminium 3D Hexagon Metal	356	Krabi	138
Form Abstract Brown	277	Gravity Aluminium 3D Hexa. Rose Gold	358		
Form Abstract Cream	277	Gravity Aluminium Arrow Gold	357	L	
Form Abstract White	277	Gravity Aluminium Arrow Metal	356	Lagos Black Home	73
Form Hub Brown	277	Gravity Aluminium Arrow Rose Gold	358	Lamina Aislante Laminado	600
Form Hub Cream	277	Gravity Aluminium Cubic Gold	357	Lamina Aislante Linkfloor	678
Form Hub White	277	Gravity Aluminium Cubic Metal	356	Lamina Aislante Parquet	526
Fusion 3D Caramel Mix	335	Gravity Aluminium Cubic Rose Gold	358	Lamina Antihu. + Espuma Laminado	600
Fusion 3D Steel Mix	335	Gravity Aluminium Hexagon Gold	357	Lamina Antihu. + Espuma Linkfloor	678
Fusion Brick 3D Caramel Mix	334	Gravity Aluminium Hexagon Metal	356	Lamina Antihu. + Espuma Parquet	526
Fusion Brick 3D Steel Mix	334	Gravity Aluminium Hexagon Rose Gold	358	Lamina Suelo Rad. Antiest. Linkfloor	678
Fusion Brick 3D White	334	Gravity Aluminium Trace Gold	357	Lamina Suelo Rad. Antiest. Parquet	526
Fusion Hexagon Caramel Mix	335	Gravity Aluminium Trace Metal	356	Lamina Suelo Radiante Antiest. Lam.	600
Fusion Hexagon Steel Mix	335	Gravity Aluminium Trace Rose Gold	358	Lavabo + Encimera + Boston	174
Fusion Hexagon White	335			Lavabo + Encimera + P.ducha 120 Cr. Ita.	175
Fusion Mini Strip Caramel Mix	334	H		Lavabo + Encimera + P.ducha 90 Cr. Ita.	175
Fusion Mini Strip Steel Mix	334	Habana Brown Classico	38	Lavabo + Encimera Crema Italia	174
Fusion Mini Strip White	334	Habana Brown Pulido	38	Legacy Ceniza	443
Fusion Triangles Caramel	335	Habana Brown Sand Home	39	Legacy Cognac	443
Future	157	Habana Dark Classico	41	Legacy Tobacco	442
		Habana Dark Pulido	41	Legacy Vulcano	442
G		Habana Grey Classico	40	Legend 1L Light	504
Geisha	141	Habana Grey Pulido	40	Legend 1L Neutral	504
Genuine 1L Great Basin	595	Hampton	170	Lines Cambric Carrara Pulido	266
Genuine 1L Mojave	594	Harmony Arrow Coltan	311	Lines Cambric Persian White Classico	266
Genuine 1L Sonoran	594	Harmony Arrow Gold	311	Lines Cambric Persian White Pulido	266
Giallo Conte	112	Harmony Arrow Silver	311	Lines Cambric Silver Wood Classico	267
Glacier Moon Metallic Black	296	Harmony Strip Coltan	311	Lines Cambric Silver Wood Pulido	266

Product Index / Índice Productos / Index Des Produits

Lines Mini Cambric Persian White Class.	266		
Lines Mini Cambric Persian White Pulido	266		
Lines Mini Cambric Silver Wood Classico	267		
Lines Mini Cambric Silver Wood Pulido	267		
Lines Safary Brown	267		
Lines Safary White	267		
Lines Silver Wood Grey	267		
Linkfloor Contract Clay	618		
Linkfloor Contract Cotton	617		
Linkfloor Contract Diamond	615		
Linkfloor Contract Graphite	614		
Linkfloor Contract Gravel	617		
Linkfloor Contract Sand	616		
Linkfloor Contract Steel	614		
Linkfloor Contract Titanium	615		
Linkfloor Contract Zinc	616		
Linkfloor Empire Brown	674		
Linkfloor Empire Cream	674		
Linkfloor Empire Light Grey	675		
Linkfloor Empire Tan	675		
Linkfloor Hotel Air Ash	666		
Linkfloor Hotel Air Earth	667		
Linkfloor Hotel Air Maple	668		
Linkfloor Hotel Air Mist	667		
Linkfloor Hotel Air Silver	668		
Linkfloor Hotel Air Walnut	666		
Linkfloor Loose Lay Contract Clay	651		
Linkfloor Loose Lay Contract Cotton	650		
Linkfloor Loose Lay Contract Diamond	648		
Linkfloor Loose Lay Contract Graphite	648		
Linkfloor Loose Lay Contract Gravel	651		
Linkfloor Loose Lay Contract Sand	650		
Linkfloor Loose Lay Contract Steel	652		
Linkfloor Loose Lay Contract Titanium	649		
Linkfloor Loose Lay Contract Zinc	649		
Linkfloor Oak Dark	658		
Linkfloor Oak Grey	659		
Linkfloor Oak Natural	658		
Linkfloor Oak White	659		
Linkfloor Roll Contract Clay	627		
Linkfloor Roll Contract Cotton	626		
Linkfloor Roll Contract Diamond	624		
Linkfloor Roll Contract Graphite	624		
Linkfloor Roll Contract Gravel	627		
Linkfloor Roll Contract Sand	626		
Linkfloor Roll Contract Steel	628		
Linkfloor Roll Contract Titanium	625		
Linkfloor Roll Contract Zinc	625		
Linkfloor Wall Contract Clay	637		
Linkfloor Wall Contract Cotton	636		
Linkfloor Wall Contract Custom	644		
Linkfloor Wall Contract Diamond	635		
Linkfloor Wall Contract Graphite	634		
Linkfloor Wall Contract Gravel	637		
Linkfloor Wall Contract Sand	638		
Linkfloor Wall Contract Steel	634		
Linkfloor Wall Contract Titanium	635		
Linkfloor Wall Contract Zinc	636		
LS 1L Africa	561		
LS 1L Amazon	561		
LS 1L Blanco Decape	566		
LS 1L Boston	565		
LS 1L Castaño Sunset	566		
LS 1L Ebano	560		
LS 1L Illinois	562		
LS 1L Michigan Brown	562		
LS 1L Michigan Clear	563		
LS 1L Michigan Dark Brown	560		
LS 1L Michigan Grey	564		
LS 1L Texas	564		
LS 1L Valley	563		
Luxe Mirror Cubes	303		
Luxe Mirror Hexagon	303		
Luxe Mirror Strip	303		
Luxury Modul Copper	279		
Luxury Modul Gold	279		
Luxury Modul Silver	279		
		M	
		Magma Hexagon Beige	280
		Magma Hexagon Black	280
		Magma Hexagon Grey	280
		Mamperlan Laminado	601
		Mamperlan Parquet	526
		Maya	147
		Men{H}jir	186
		Men{H}jir Bañera	187
		Men{H}jir Encimera L	192
		Men{H}jir Encimera S	192
		Men{H}jir Espejo	189
		Men{H}jir Espejo L	189
		Men{H}jir Espejo S	190
		Men{H}jir Estante D	188
		Men{H}jir Estante I	188
		Men{H}jir Mueble L	191
		Men{H}jir Mueble S	191
		Men{H}jir Mueble S 3C	190
		Men{H}jir Stand	186
		Metal Acero	352
		Metal Acero Anthracite 3D Cubes	353
		Metal Acero Hexagon	352
		Metal Acero Hexagon Anthracite	352
		Metal Acero Highlights	352
		Metal Acero Highlights Golden	352
		Metal Brick Acero	352
		Metal Bronze 3D Cubes	353
		Metal Mini Cubes Dark	353
		Metal Mini Cubes Light	353
		Mini Eden 1L Brown	491
		Mini Eden 1L Camel	488
		Mini Eden 1L Dark Grey	492
		Mini Eden 1L Light Grey	492
		Mini Eden 1L Marengo	490
		Mini Eden 1L Natural	488
		Mini Eden 1L Sand	490
		Mini Eden 1L Wenge	493
		Mini Eden 1L White	489
		Mini Eden Texture 1L Almond	500
		Mini Eden Texture 1L Cinamon	500
		Mini Eden Texture 1L Nut	501
		Mini Iris Black Pearl	305
		Mini Iris Cream Pearl	305
		Mini Iris Grey Pearl	305
		Mini Iris White Pearl	305
		Minim Encimera + Lavabo	204
		Minim Espejo 160x60cm	205
		Minim Espejo 80x80cm	205
		Minim Lavabo	202
		Minim Lavabo + Encimera	203
		Minim Lavabo Doble	203
		Minim Lavabo Stand	202
		Minim Wood	208
		Minim Wood Doble	209
		Minim Wood Encimera + Lavabo	210
		Minim Wood Lavabo + Encimera	209
		Minim Wood Stand	208
		Modern Multiformato Ceniza	434
		Modern Multiformato Natural	434
		Modern Multiformato Siena	435
		Moka Anticato	46
		Moka Classico	46
		Montreal Classico	65
		Moon Marmara	273
		Moon Mix Browns	273
		Moon Silver Wood	273
		N	
		Nairobi Crema Classico	35
		Nairobi Crema Pulido	35
		Nairobi Grey Classico	36
		Nairobi Grey Pulido	36
		Natural 1L Michigan Brown	556
		Natural 1L Amazon Light	556
		Natural 1L Ebano	554
		Natural 1L Loft	555
		Natural 1L Marron Decape	555
		Natural 1L Michigan Clear	557
		Natural 1L Roble Life	557
		Natural 1L Texas	554
		Nature 1L Brown	516
		Nature 1L Grey	517
		Nature 1L Natural	518
		Nature 1L Toasted	516
		Nature 1L White	517
		Navona	145
		Nazari Asilah	382
		Nazari Chauen	382
		Nazari Fes	382
		Nazari Ifrane	382
		Nazari Marrakech	382
		Nazari Sale	382
		Nepal Natural	84
		O	
		Ocean Wood Classico	50
		Onix Botafogo	114
		Onix Etnia	116
		Onix Ipanema	115
		Onix Lagoa	114
		Onix Lava	116
		Ottawa Pulido	69
		Outlines Bars Capuccino Lin. Hom.	270
		Outlines Bars Hab. Brown Lin. Hom.	270
		Outlines Brick Burma	270
		Outlines Brick Lhasa-Sha.-Burma	270
		Outlines Mini Strip Bhutan	270
		Outlines Mini Strip Canyon	271
		Outlines Mini Strip Nepal	270
		Outlines Mini Strip Shannan	271
		P	
		Paradise Arrow Blanco	276
		Paradise Arrow Gris	276
		Paradise Arrow Negro	276
		Paradise Baia Stone Blanco	274
		Paradise Baia Stone Cremas	274
		Paradise Baia Stone Negro	274
		Paradise Lake Stone Blanco	274
		Paradise Lake Stone Cremas	274
		Paradise Lake Stone Negro	274
		Paradise Minibroken Edge Blanco	275
		Paradise Minibroken Edge Negro	275
		Paradise Round Stone Blanco	275
		Paradise Round Stone Negro	275
		Paradise Tinybroken Cubes Blanco	275
		Paradise Tinybroken Cubes Negro	275
		Paradise Tinybroken Edge Blanco	276
		Paradise Tinybroken Edge Gris	276
		Paradise Tinybroken Edge Negro	276
		Patagonia Home	83
		Perfil Igualación Aluminio Laminado	601
		Perfil Igualación Aluminio Parquet	526
		Perfil Transición Aluminio Laminado	601
		Perfil Transición Aluminio Parquet	526
		Persian White Classico	27
		Persian White Pulido	27
		Phuket	138
		Port Cannes	113
		Port Monaco	112
		Q	
		Quercus 1L Brown	598
		Quercus 1L Light Grey	598
		Quercus 1L Natural	599
		R	
		Residence 1L Arizona	576
		Residence 1L Idaho	574
		Residence 1L Misuri	575
		Residence 1L Nevada	575
		Residence 1L New Jersey	570
		Residence 1L Nogal	574
		Residence 1L Roble	571
		Residence 1L Roble Decape	571

Product Index / Índice Productos / Index Des Produits

Residence 1L Utah	576	Stone Mirror 1600x1000	245	Urban Line Copper	314
Residence 1L Vermont	572	Stone Mirror 800x1000	244	Urban Line Iron	314
Residence 1L Virginia	572	Stone Mirror D 950	244	Urban Line Lead	314
Residence 2L Iowa	570	Style 1L Calm	581	Urban Line Nickel	314
Residence 3L Ohio	573	Style 1L Mild	580	Urban Line Silver	314
Retro Blanco	404	Style 1L Quiet	581	Urban Line Zinc	314
Revelation 1L Everglades	587	Style 1L Smooth	580	Urban Retro Iron	313
Revelation 1L Katmai	587	Style 1L Soft	582	Urban Retro Lead	313
Revelation 1L Yellowstone	586	Styledeck Plus Brown	539	Urban Retro Nickel	313
Revelation 1L Yosemite	586	Styledeck Plus Dark	538	Urban Retro Silver	313
Revival 1L Cognac	508	Styledeck Plus Grey	538	Urban White	315
Revival 1L Ocher	509			Urban White Frost	315
Revival 1L Oyster	508				
Riverside Gold	405	T		V	
Riverside White	405	Tecno Bhutan Silver Glass	328	Vaciador Fijo Tapa Piedra	149
Rmc Grease Remove 0,5 L	527	Tecno Br. Bhutan Silver Glass	328	Vancouver Classico	68
Rmc Limespot Remove 0,5 L	527	Tecno Br. Nepal Golden Glass	328	Victorian Blanco Marmara	290
Rmc Soap 1L	527	Tecno Glass Country	329	Victorian Chain Marmara Mirror	290
Rmc Surface Care 750 mL	527	Tecno Linear Brown Capuccino	329	Victorian Chain Marmara-Marquina	290
Rmc Univer. Main. Oil Color 0,5 L	527	Tecno Linear Cream Capuccino	329	Victorian Diamond Marmara-Mirror	290
Rmc Univer. Main. Oil Pure 0,5 L	527	Tecno Linear Cream Habana	329	Victorian Island Star White	290
Romo Retro Blanco	404	Tecno Linear Silver White	328	Victorian Mother of Pearl Brown	291
Round	147	Tecno Nepal Decor	328	Victorian Mother of Pearl Grey	291
		Tecno Nepal Golden Glass	328	Victorian Mother of Pearl White	291
S		Tecno Quarz Emerald	329	Victorian Trenzado Marmara Gris	291
Sahara Anticato	66	Tecno Quarz Mountain	329	Victorian Trenzado Marmara Negro	290
Saint Denis Espejo Place	230	Tectonics Bend	106	Vintage	235
Saint Denis Espejo Tour	231	Tectonics Range	106	Vintage Espejo L	236
Saint Denis Lavabo	230	Time Text. Linear Cream	336	Vintage Espejo S	236
Saint Germain Espejo Étagère	226	Time Text. Linear Silk Wood	336	Vintage L	234
Saint Germain Espejo Place	227	Time Text. Linear Silver Wood	336	Vintage S	234
Saint Germain Espejo Tour	226	Time Text. Silk Wood	336		
Saint Germain Lavabo	224	Time Text. Silver Wood	336	W	
Saint Germain Structure	225	Time Texture Cream	336	W-Tower	170
Saint Germain Totem	224	Tortona 1L Borgo	459	Weft Beige	283
Saint Germain Totem Crochet	225	Tortona 1L Fiera	454	Weft Grey	283
Samara	156	Tortona 1L Fonte	455	Wood Boxes	366
Samui	152	Tortona 1L Palazzo	457	Wood Brick	367
Shape	146	Tortona 1L Piazza	458	Wood Cubes	366
Sherpa Brown Home	74	Tortona 1L Strada	458	Wood Even	366
Shima	141	Tortona 1L Viale	456	Wood Feel	366
Signature Tile Copper	396	Tortona 1L Walnut	456	Wood Lovers 1L Brown	522
Signature Tile Cream Glossy	396	Tortona 1L Wenge	454	Wood Lovers 1L Brown Lisbon	522
Signature Tile Cream Matt	396	Toscana Firenze	282	Wood Lovers 1L Grey Newman	522
Signature Tile Mud	397	Toscana Massa	282	Wood Lovers 1L Grey Night	522
Signature Tile Shell	397	Toscana Anticato	47	Wood Lovers 1L Natural	522
Signature Tile Silver	396	Touch Bottle	386	Wood Lovers 1L Warm Ocean	522
Signature Tile Smoke	397	Touch Linen	386	Wood Modul	367
Signature Tile White Glossy	396	Touch Navy	386	Wood Square Aged	366
Signature Tile White Matt	396	Touch Pearl	386	Wood Square Aged 3D	366
Silk Wood Classico	49	Tower Mirror	182	Wood Square Antique	367
Silver Wood Classico	48	Treasures Bronz. Emper.	332	Wood Top 110	164
Skyline Blind Dark	278	Treasures Bronz. Emper. Moon	332	Wood Top 160	164
Skyline Linear Broken Dark	278	Treasures Bronz. Emper. Strip	332	Wood Top 80	165
Skyline Mix Broken Dark	278	Treasures Mist Shannan	333	Wood Wall Anthracite	368
Skyline Wave Dark	278	Treasures Mist Shannan	333	Wood Wall Bronze	368
Soporte Encimera 150x55cm	166	Treasures Mist Shannan Moon	333	Wood Wall Chrome	368
Soporte Encimera 70x47,5cm	166	Treasures Mist Shannan Strip	333	Wood Wall Pure	368
Soporte Encimera con Forma	166	Trend	144	Wood Wall Teak	369
Soporte Encimera Recto	166	Trend Stripes Browns	338	World Amsterdam Brick Beige	261
Soul Hollow	140	Trend Stripes Greys	338	World Amsterdam Brick Grey	261
Spirit Espejo Neboa	219	Trend Stripes Whites	338	World Beige	260
Spirit II Espejo	219	Treville 1L Suede	463	World Blanco Almeria	260
Spirit II Lavabo	218	Treville 1L Chocolate	462	World Crema Italia	260
Spirit Lavabo	218	Treville 1L Concrete	462	World Hexagon Text. Grey	260
Spirit Mueble	220	Treville 1L Leather	463	World Random Nepal	260
Stark Black	308	Treville 1L Mist	464	World Random Shannan	260
Stark Grey	308	Tribal Pearl Black	327	Worn Copper	359
Stark White	308	Tribal Pearl Brown	327	Worn Hexagon Copper	339
Statuario Altisimo	111	Tribal Pearl White	327	Worn Hexagon Verdigris	339
Stone Basin Countertop 400 Angled	240			Worn Verdigris	359
Stone Basin Countertop 400 Straight	240	U		Z	
Stone Basin Wall Mounted 400	241	Universe Aurora	284	Zen	153
Stone Basin Wall Mounted 600	242	Universe Dusk	284	Zen Wood	142
Stone Basin Wall Mounted 800	242	Universe Hexagon Blue	284	Zeno	144
Stone Freestanding Bathtub	243	Universe Hexagon Green	284	Zocalo Blanco Laminado	601
Stone Mirror 1200x1000	245	Urban Grey	315	Zócalo Parquet Blanco	526
		Urban Grey Frost	315		

01



Floor Coverings Paradise Tinybroken Edge Negro / Wall Coverings Airslate Graphite / Complementary Products Conjunto Karon Circle Persian White - Nogal Intense, Tower Mirror Nogal Intense.

Natural Stone

L'Antic Colonial's stone is a natural product which may be subject to variations in shade. The colour of the material supplied may differ slightly from that shown. Our website (<http://anticcolonial.com/piedra-natural/en/natural-stone/>) contains further information in respect of our stone products, such as installation guides and videos, technical data sheets, details on larger formats, textures or recommendations for use.

Todas las piedras de L'Antic Colonial son productos naturales que pueden sufrir variaciones de tono. El color del material servido puede no ser exactamente igual al de la muestra. En nuestra página web (<http://anticcolonial.com/piedra-natural/>) encontrará información adicional de nuestras piedras como guías y vídeos de instalación, fichas técnicas, tablas de mayor formato, texturas o recomendaciones de uso.

Toutes les pierres de L'Antic Colonial sont des produits naturels qui peuvent subir des variations de tonalité. La couleur du matériau fourni peut être légèrement différente de celle de l'échantillon. Sur notre site Internet (<http://anticcolonial.com/fr/pierre-naturelle/>), vous trouverez des informations supplémentaires sur nos pierres: manuels et vidéos d'installations, fiches techniques, tableaux avec les formats disponibles, textures ou recommandations d'utilisation.



Floor Coverings Habana Brown Sand Home / Wall Coverings Habana Brown Sand Home

Natural Stone / Piedra Natural / Pierre Naturelle

REMEMBER

All natural products are perfectly imperfect. The differences found between pieces make each piece unique and unrepeatable. This feature is NOT A PRODUCT DEFECT but an inherent part of the beauty of the product.

If we are able to convey an understanding of the features of our products, we are sure that we will be able to meet all your expectations as regards quality and beauty. This is why it is essential that you are aware that you are buying a natural product, the characteristics of which may, on occasions, include:

1.- Pinhole cavities filled with grout

The surface of some materials, as for example the travertines, is covered with pinhole cavities. These cavities are treated with a grout, as similar as possible in colour to that of the stone. This characteristic is part of the nature of the product and at no time is it a sign of a defective product.

2.- Repaired fissures or cracks

It is normal for small cracks to appear on the surface of the stones. These are repaired with resins. This helps to strengthen the stone and increase its subsequent performance. This characteristic occurs frequently in natural products and should be taken into account when selecting products for a project.

3.- Changes in shade

All the natural products vary in shade and in the structure of the piece. The pieces undergo an exhaustive sorting process at L'Antic Colonial and any that do not meet our exacting quality standards are rejected. Possible variations are listed in the technical specifications of the products. If you have chosen one of our products for your project, we suggest you request photos of the panels or a few square metres of sample before making your purchase.

"IF YOU INVEST IN BEAUTY, IT WILL REMAIN WITH YOU FOR THE REST OF YOUR LIFE"

Frank Lloyd Wright

A TENER EN CUENTA

Todos los materiales naturales son perfectamente imperfectos. La variación existente entre piezas hace que cada una de ellas sea única e irrepetible. Esta característica NO ES UN DEFECTO DEL MATERIAL sino una parte inherente de la belleza del producto.

Si somos capaces de trasladarle las características de nuestros productos estamos convencidos que cubriremos sus expectativas en cuanto a calidad y belleza. Por ello es muy importante que entienda que está comprando un producto natural cuyas características incluyen en algunos casos:

1.- Coqueiras rellenas de masilla

Algunos materiales, como por ejemplo los travertinos, presentan coqueiras en su superficie. Estas cavidades se tratan con una masilla del color posible más parecido al de la piedra. Esta característica forma parte del material y en ningún momento indica que se trata de un producto defectuoso.

2.- Fisuras o grietas reparadas

En la superficie de las piedras suelen aparecer grietas que son reparadas con resinas. De este modo se refuerza la pieza y se aumenta su rendimiento posterior. Esta característica es muy común en la mayoría de productos naturales y se debe tener en cuenta a la hora de seleccionarlos para un proyecto.

3.- Variación de tonalidad

Todos los materiales naturales varían tanto en tono como en la propia estructura de la pieza. Desde L'Antic Colonial se realiza una exhaustiva clasificación mediante la que se eliminan los elementos que no superan nuestros estándares de calidad. En las fichas técnicas de nuestros productos se muestran las posibles variaciones de los mismos. Si ha seleccionado uno de nuestros materiales para su proyecto, le recomendamos que solicite imágenes de las tablas o unos metros cuadrados de muestra antes de realizar la compra.

"SI INVIERTES EN BELLEZA, ÉSTA TE ACOMPAÑARÁ EL RESTO DE TU VIDA"

Frank Lloyd Wright

À PRENDRE EN COMPTE

Tous les matériaux naturels sont parfaitement imparfaits. La variation existante entre les pièces les rend uniques. Cette caractéristique N'EST PAS UN DÉFAUT DU MATÉRIAU mais une part inhérente de la beauté du produit.

Si nous sommes capables de vous transmettre les caractéristiques de nos produits, nous sommes persuadés que nous répondrons à vos attentes en termes de qualité et beauté. Pour cela il est très important que vous compreniez que vous achetez un produit naturel dont les caractéristiques incluent dans certains cas:

1.- Alvéole remplies d'enduit

Certains matériaux, comme par exemple les travertins, présentent des alvéoles en surface. Ces cavités sont traitées avec un enduit d'une couleur la plus proche possible de la pierre. Cette caractéristique est inhérente au matériau et n'indique absolument pas qu'il s'agit d'un produit défectueux.

2.- Fissures ou craquelures réparées

Des fissures apparaissent souvent sur la surface des pierres et sont traitées avec des résines. La pierre est ainsi renforcée et son rendement ultérieur accru. Cette caractéristique est très commune sur la majorité des produits naturels et doit être prise en compte au moment de la sélection pour un projet.

3.- Variation de tonalité

Tous les matériaux naturels varient à la fois au niveau du ton et de la structure même de la pièce. Chez L'Antic Colonial nous procédons à un classement exhaustif qui permet d'éliminer les éléments qui ne répondent pas à nos standards de qualité. Sur les fiches techniques de nos produits sont indiquées leurs variations éventuelles. Si vous avez sélectionné l'un de nos matériaux pour votre projet, nous vous recommandons de demander des images des lames ou quelques mètres carrés d'échantillon avant de réaliser votre achat.

"SI VOUS MISEZ SUR LA BEAUTÉ, ELLE VOUS ACCOMPAGNERA LE RESTE DE VOTRE VIE"

Frank Lloyd Wright



Bioprot

PROTECTION APPLIED TO ALL SURFACES

A new waterproofing process for stone which **improves the qualities of natural stone**. The layer, which to date has only been applied to the upper surface, **is now applied to the remaining faces** of each of the pieces on the L'Antic Colonial production line. As a result, all sides, including the underside of the piece, now possess the same qualities as the surface.

This technological advance stems from **research aimed at completely protecting** all L'Antic Colonial pieces from the possible effects of glues, adhesives or the floor's moisture content, both at the time of installation and with the least possible effect over time.

It should be borne in mind that all natural stone, depending on type, has a degree of porosity, which is an intrinsic characteristic of natural stone. With this new process, we have sought to protect the faces so that external factors do not alter the qualities of natural stone.

PROTECCIÓN APLICADA A TODAS LAS CARAS

*El nuevo proceso de impermeabilización de la piedra **mejora las características propias de la piedra natural**. A la capa aplicada hasta ahora sobre la superficie útil, se le suma el **mismo proceso en el resto de caras** de cada una de las piezas que pasan por la línea de producción de L'Antic Colonial, con lo que todos los laterales de la pieza y la cara inferior de la misma pieza, acaban teniendo las mismas características que hasta ahora tenía sólo la cara superficial.*

*La evolución viene dada por la **búsqueda de la protección total** de cada una de las piezas que produce L'Antic Colonial, y así evitar que cualquier posible afectación por las colas, cementos o humedades del suelo en el momento de la instalación, afecten el mínimo posible con el paso del tiempo.*

No hay que olvidar que en función del tipo de piedra natural, esta tiene un grado de porosidad, característica intrínseca de la piedra natural, con lo que con este nuevo proceso, lo que se busca es la protección de la superficie para que los agentes externos no alteren las características de la misma piedra natural.

PROTECTION APPLIQUÉE SUR TOUTES LES FACES

*Le nouveau processus d'imperméabilisation de la pierre **améliore les caractéristiques propres à la pierre naturelle**. Outre la couche appliquée jusqu'à présent sur la surface utile, **le même procédé est ajouté à toutes les autres parties** de chacune des pièces qui passent par la ligne de production de L'Antic Colonial. Par conséquent, tous les côtés et la face inférieure des pièces ont désormais les caractéristiques que possédaient jusqu'à présent la partie superficielle uniquement.*

*Cette évolution est le fruit de la **recherche d'une protection totale** pour chacune des pièces produites par L'Antic colonial. L'objectif est de faire en sorte que les éventuels défauts dus aux colles, aux ciments, à l'humidité du sol au moment de la pose aient un impact minimum sur la durée.*

Il est important de savoir qu'en fonction du type de pierre naturelle, celle-ci a un degré de porosité, ce qui est l'une de ses caractéristiques intrinsèques. Le but est de protéger la surface pour que les agents externes altèrent le moins possible ses caractéristiques.



Topside protection
Protección cara superior
Protection face supérieure



Underside protection
Protección cara inferior
Protection face inférieure



Side protection
Protección caras laterales
Protection faces latérales

01

Formats / Formatos / Formats

-

MULTIFORMATO 40,6x61cm / 40,6x40,6cm / 20x40,6cm / 20x20cm
MULTIFORMAT 16"x24" / 16"x16" / 7 7/8"x16" / 7 7/8"x7 7/8"



160x60cm
63"x23 5/8"

40x80cm
15 3/4"x31 1/2"

30x60cm
11 3/4"x23 5/8"

10x60cm
3 7/8"x23 5/8"

Formats / Formatos / Formats

80x80cm
31 1/2"x31 1/2"

120x240cm
47 1/4"x94 1/2"

SLAB
TABLA

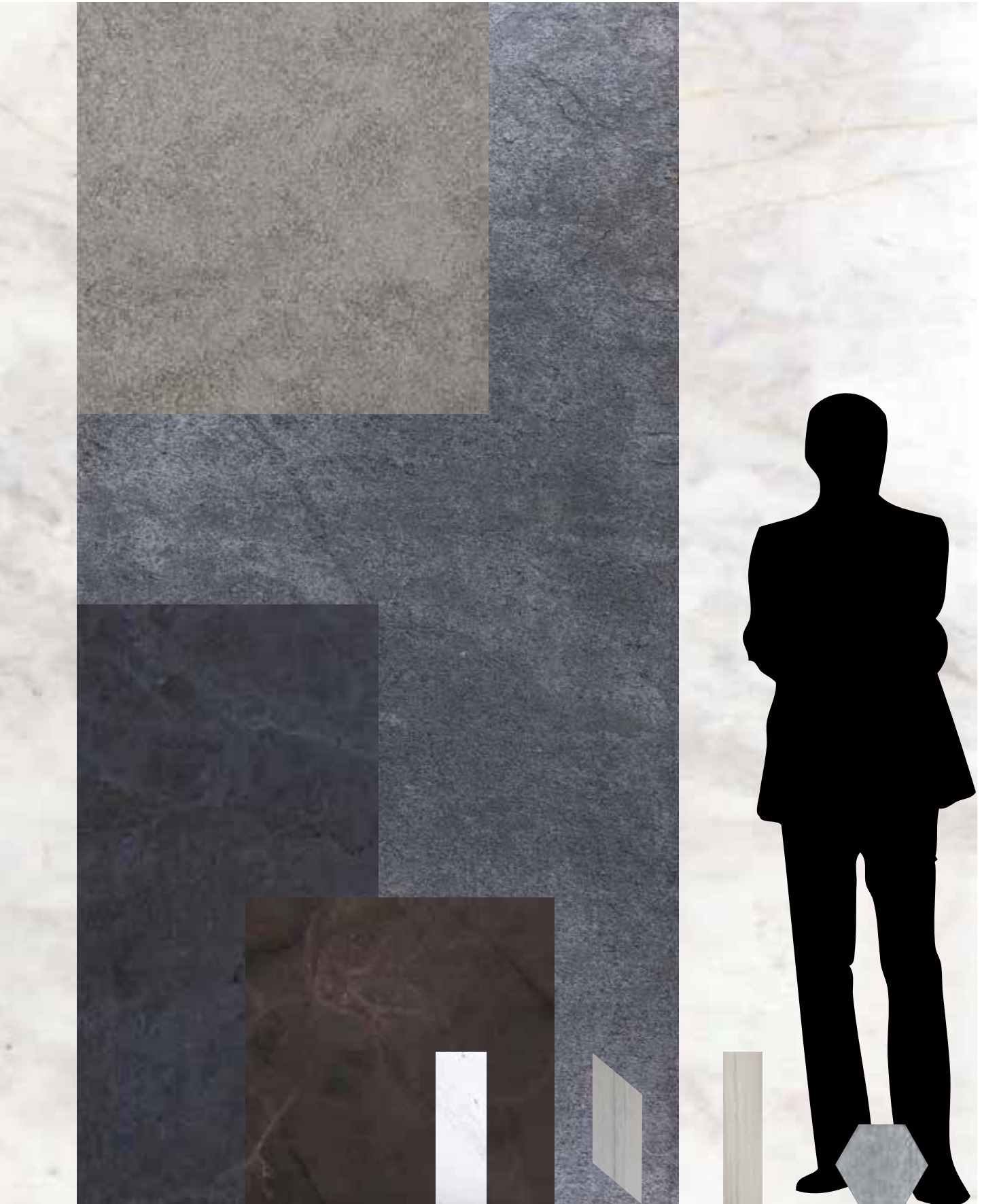

120x60cm
47 1/4"x94 1/2"

60x60cm
23 5/8"x23 5/8"

9,8x30cm
3 7/8"x11 3/4"

10x25cm
3 7/8"x9 7/8"

7,5x30cm
3"x11 3/4"

19x19cm
7 1/2"x7 1/2"



ANTICATO

The stone is naturally aged to give it a warm, traditional look.

Las piezas se envejecen de manera natural para conseguir una estética cálida y tradicional.

Les pièces sont vieilles de façon naturelle pour obtenir une esthétique chaude et traditionnelle.

TEXTURE

A natural, rustic finish with a rough, grooved texture is achieved by pounding the stone with pointed machine heads.

Acabado rústico y natural con textura estriada y rugosa logrado por medio del golpeo con cabezales en forma de punta.

Finition rustique et naturelle d'une texture striée et rugueuse, obtenue en frappant le matériau avec des têtes en forme de pointes.

FLAMED

Featuring a rough texture, achieved through exposure to fire.

Textura rugosa conseguida con la exposición al fuego.

Texture rugueuse obtenue par exposition au feu.

FLAMED HOME

Featuring a rough texture, achieved through exposure to fire and mechanical brushing.

Textura rugosa conseguida con la exposición al fuego y cepillada mediante cepillos mecánicos.

Texture rugueuse obtenue par exposition au feu et brossage au moyen de brosses mécaniques.

SAND

Featuring a slightly rough surface, achieved by sandblasting.

Conseguir una superficie ligeramente rugosa mediante chorro de arena.

Surface à texture légèrement obtenue par sablage.

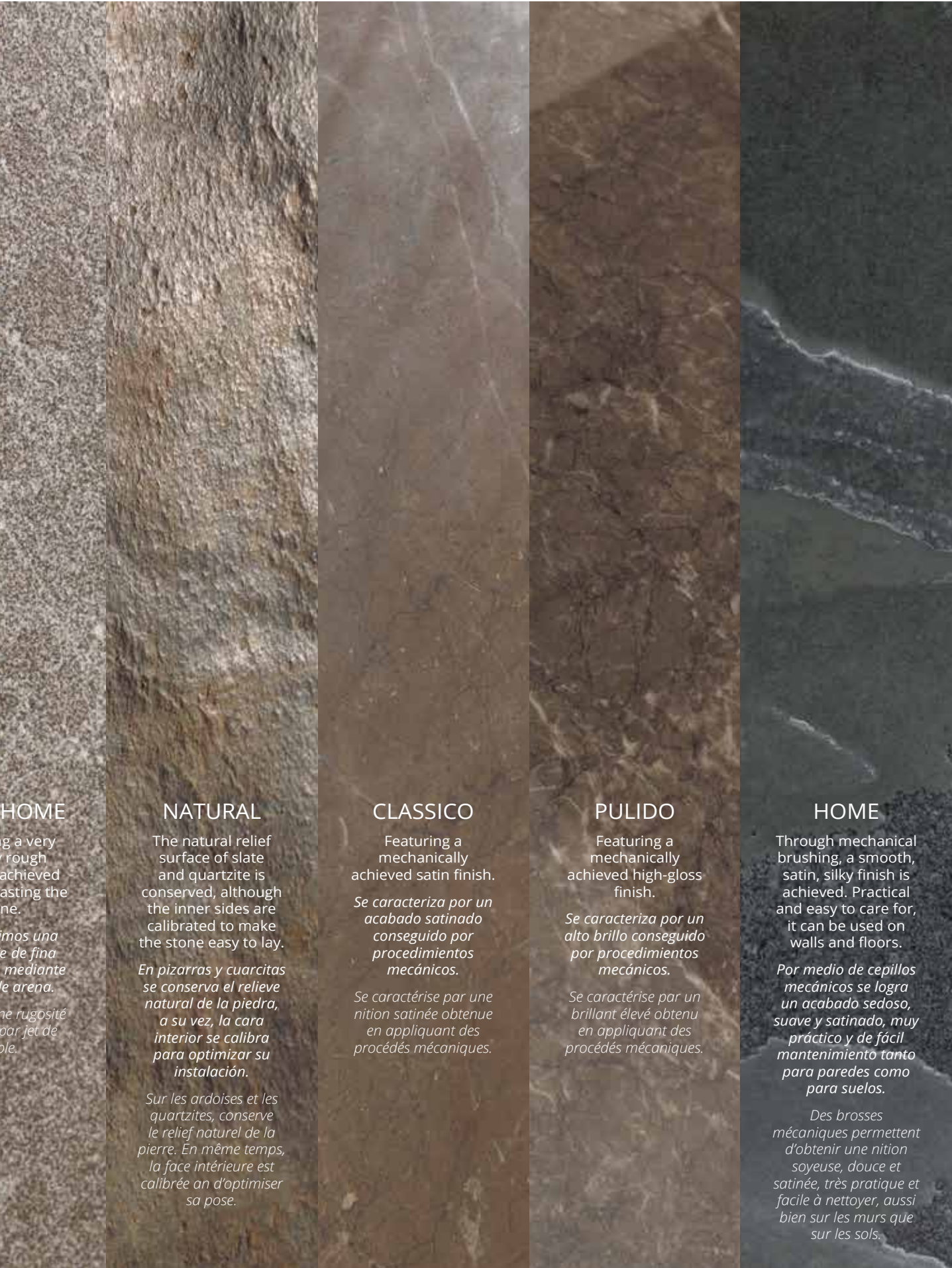

HOME

g a very rough achieved lasting the ne.

imos una e de fina mediante le arena.

ne rugosité par jet de ole.

NATURAL

The natural relief surface of slate and quartzite is conserved, although the inner sides are calibrated to make the stone easy to lay.

En pizarras y cuarcitas se conserva el relieve natural de la piedra, a su vez, la cara interior se calibra para optimizar su instalación.

Sur les ardoises et les quartzites, conserve le relief naturel de la pierre. En même temps, la face intérieure est calibrée an d'optimiser sa pose.

CLASSICO

Featuring a mechanically achieved satin finish.

Se caracteriza por un acabado satinado conseguido por procedimientos mecánicos.

Se caractérise par une nition satinée obtenue en appliquant des procédés mécaniques.

PULIDO

Featuring a mechanically achieved high-gloss finish.

Se caracteriza por un alto brillo conseguido por procedimientos mecánicos.

Se caractérise par un brillant élevé obtenu en appliquant des procédés mécaniques.

HOME

Through mechanical brushing, a smooth, satin, silky finish is achieved. Practical and easy to care for, it can be used on walls and floors.

Por medio de cepillos mecánicos se logra un acabado sedoso, suave y satinado, muy práctico y de fácil mantenimiento tanto para paredes como para suelos.

Des brosses mécaniques permettent d'obtenir une nition soyeuse, douce et satinée, très pratique et facile à nettoyer, aussi bien sur les murs que sur les sols.

01 Color Range / Gama De Cores / Gamme De Couleurs

WHITE

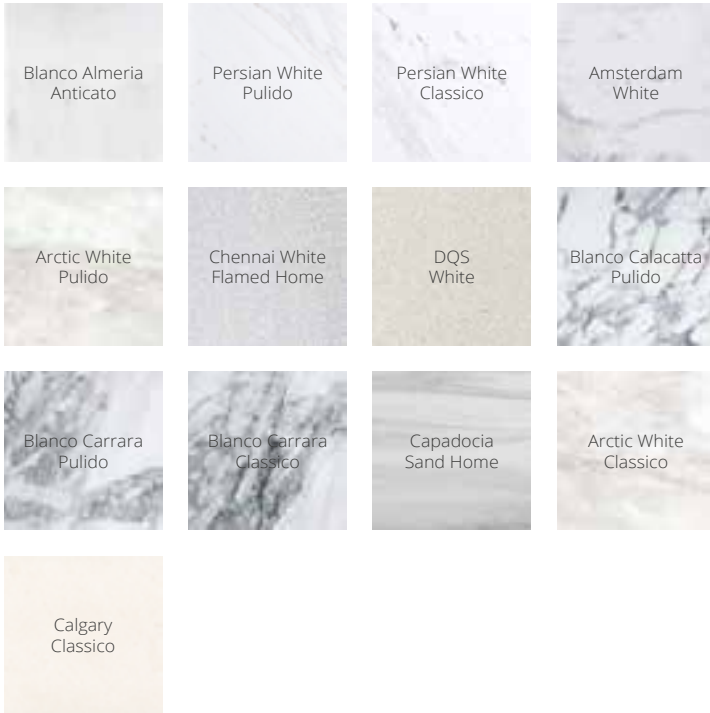

BROWN

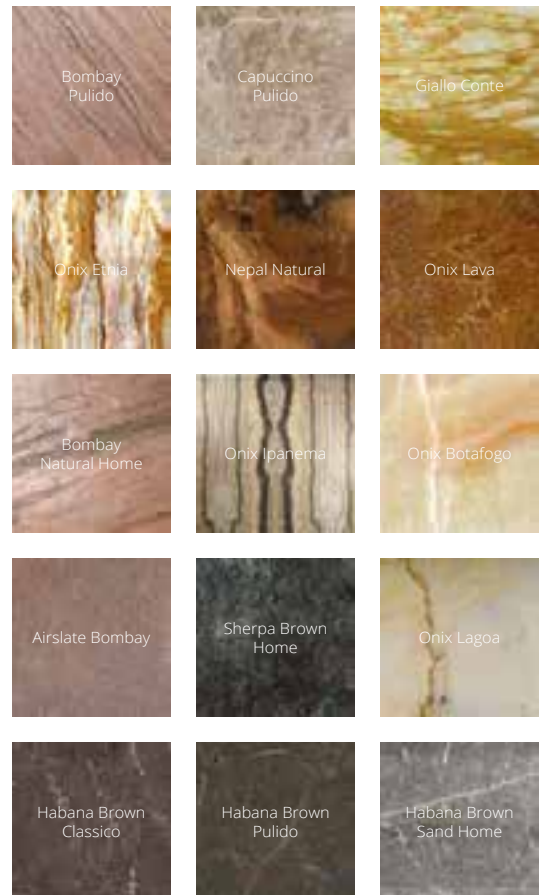

BLACK

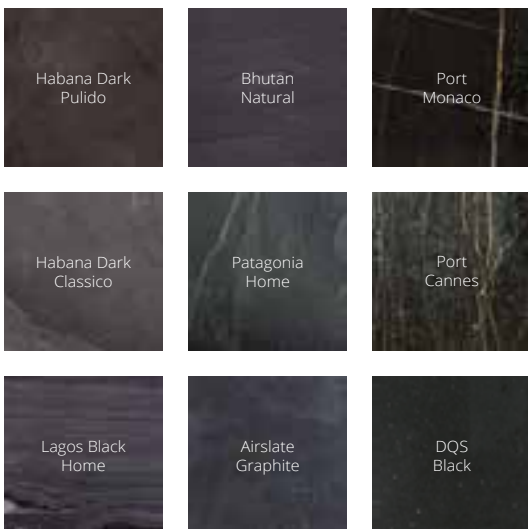

Color Range / Gama De Coiores / Gamme De Couleurs

GREY

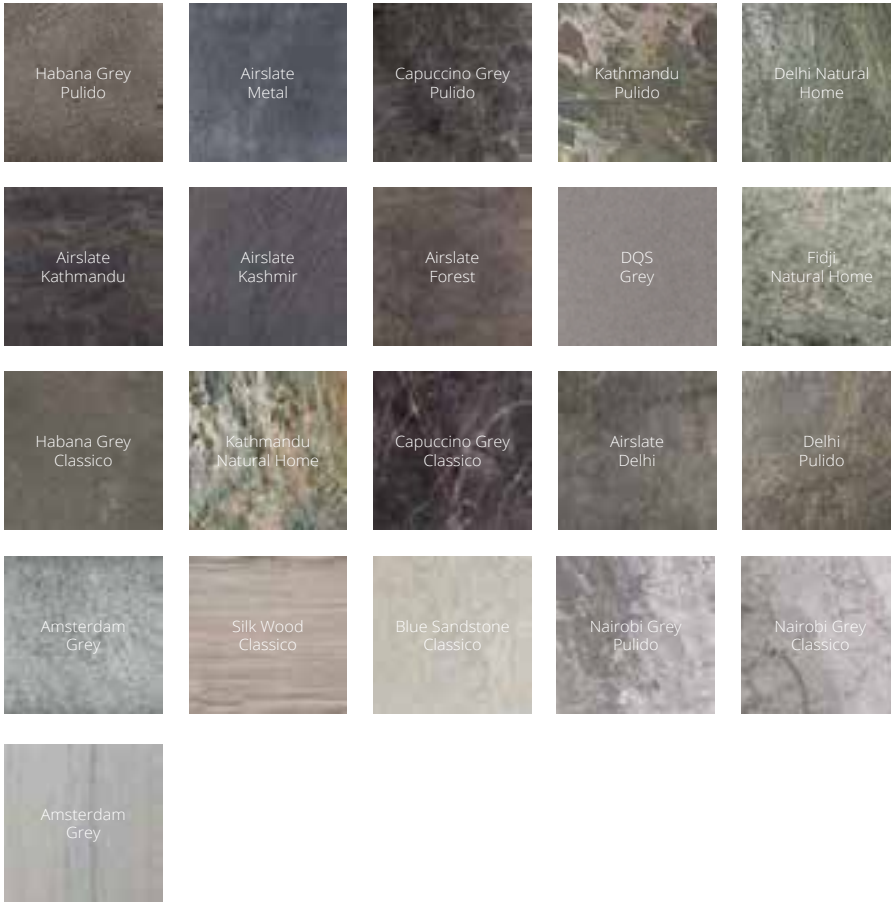

BEIGE

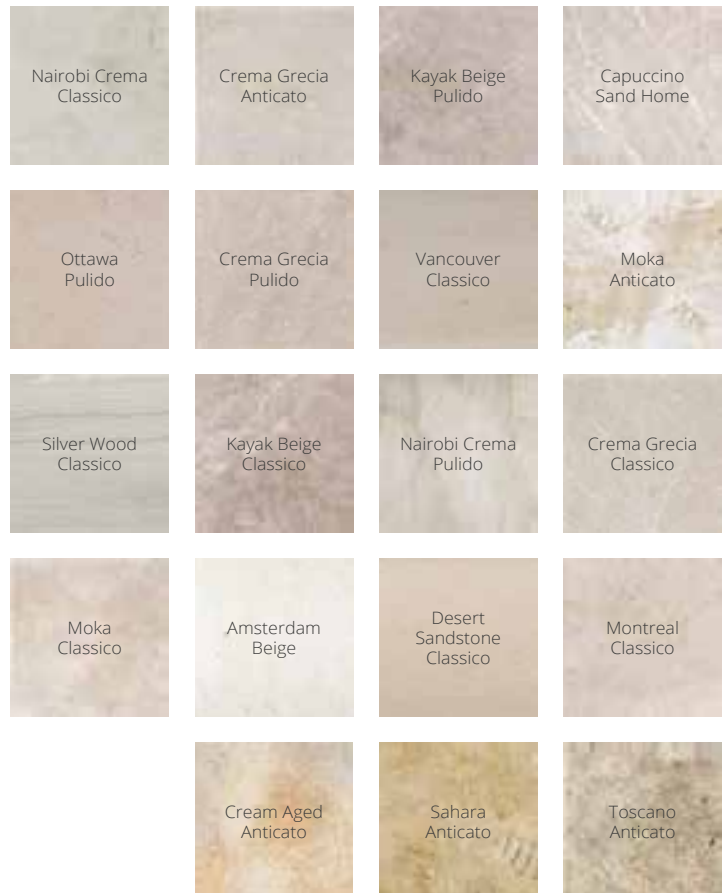

01 Description of Icons / Descripción de Iconos / Description des Icones

**IRREGULAR TEXTURE**

Material that stands out for having an asymmetrical surface.

TEXTURA IRREGULAR

Material que destaca por tener una superficie asimétrica.

TEXTURE IRRÉGULIÈRE

Matériau qui se distingue par sa surface asymétrique.

**GLOSS**

Material with surface with the ability to produce reflections.

BRILLO

Material cuya superficie tiene la capacidad de producir reflejos.

ÉCLAT

Matériau dont la surface est en mesure de produire des reflets.

**MATT**

Material with a gloss-free surface.

MATE

Material cuya superficie carece de brillo.

MAT

Matériau dont la surface n'est pas brillante.

**BEVEL**

Beveled cut on all 4 edges of the piece for emphasizing size and preventing quick damage due to the material wear and tear.

BISEL

Corte oblicuo realizado en los 4 bordes de la pieza para resaltar el tamaño y evitar el rápido deterioro por desgaste en el material.

BISEAU

Coupe oblique réalisée sur les 4 bords de la pièce pour en mettre valeur la dimension et éviter la détérioration rapide due à l'usure du matériau.

**BIOPROT**

Protection that reduces drastically the emergence of most common household bacteria.

Protección que reduce radicalmente la aparición de las bacterias domesticas mas comunes.

Protection qui réduit de façon radicale l'apparition des bactéries domestiques les plus communes.

**STRONG COLOR VARIATION**

There are considerable color changes between pieces.

VARIACIÓN DE TONO FUERTE

Existen cambios de color importantes entre piezas.

FORTE VARIATION DE TONALITÉ

Il existe d'importants changements de couleur entre les pièces.

**MODERATE COLOR VARIATION**

There are consistent color changes between pieces.

VARIACIÓN DE TONO MODERADA

Existen cambios de color regulares entre piezas.

VARIATION DE TONALITÉ MODÉRÉE

Il existe des changements de couleur réguliers entre les pièces.

**SLIGHT COLOR VARIATION**

There are slight color changes between pieces.

VARIACIÓN DE TONO LIGERA

Existen cambios de color suaves entre piezas.

LÉGÈRE VARIATION DE TONALITÉ

Il existe de légers changements de couleur entre les pièces.

**NO COLOR VARIATION**

No changes in color between pieces.

SIN VARIACIÓN DE TONO

Sin cambios de color entre piezas.

SANS VARIATION DE TONALITÉ

Sans changement de couleur entre les pièces.

**ORIGIN EUROPE**

Material from a European country.

PROCEDENCIA EUROPA

Material procedente de algún país europeo.

PROVENANCE EUROPÉENNE

Matériau en provenance d'un pays européen.

**ORIGIN AMERICA**

Material from an American country.

PROCEDENCIA AMÉRICA

Material procedente de algún país americano.

PROVENANCE AMÉRICAINE

Matériau en provenance d'un pays d'Amérique.

**ORIGIN ASIA**

Material from an Asian country.

PROCEDENCIA ASIA

Material procedente de algún país asiático.

PROVENANCE ASIATIQUE

Matériau en provenance d'un pays asiatique.

Description of Icons / Descripción de Iconos / Description des Icones



INDOOR FLOORING
Material suitable for use on indoor floors.
PAVIMENTO INTERIOR
Material apto para su uso en suelos de interior.
REVÊTEMENT DE SOL INTÉRIEUR
Matériau qui convient aux sols d'intérieur.



INDOOR WALL COVERING
Material suitable for use on indoor walls.
REVESTIMIENTO INTERIOR
Material apto para su uso en paredes de interior.
REVÊTEMENT INTÉRIEUR
Matériau qui convient aux murs d'intérieur.



COUNTERTOPS
Material suitable for use on countertops.
ENCIMERAS
Material apto para su uso en encimeras.
PLANS DE TRAVAIL/TOILETTE
Matériau qui convient aux plans de travail/toilette.



OUTDOOR FLOORING
Material suitable for use on outdoor floors.
PAVIMENTO EXTERIOR
Material apto para su uso en suelos de exterior.
REVÊTEMENT DE SOL EXTÉRIEUR
Matériau qui convient aux sols d'extérieur.



OUTDOOR WALL COVERING
Material suitable for use on outdoor walls.
REVESTIMIENTO EXTERIOR
Material apto para su uso en paredes de exterior.
REVÊTEMENT EXTÉRIEUR
Matériau qui convient aux murs d'extérieur.



RAMP CLASSIFICATION
Slip-resistance index as per current legislation.
CLASIFICACIÓN EN RAMPA
Índice de resbaladidad según la normativa vigente.
CLASSIFICATION SUR RAMPE
Indice de glissance conformément à la réglementation en vigueur.



POOL - SPA
Material suitable for use on permanently wet areas.
PISCINA - SPA
Material apto para su uso en zonas permanentemente húmedas.
PISCINE -SPA
Matériau qui convient aux zones toujours humides.



POOL SURROUNDINGS
Material suitable for use on pool surroundings.
ALREDEDORES PISCINA
Material apto para su uso en inmediaciones de piscinas.
ALENTOURS PISCINES
Matériau qui convient aux abords des piscines.



SHOWER FLOORING
Material suitable for use on shower floors.
PAVIMENTO DUCHAS
Material apto para su uso en suelos de ducha.
REVÊTEMENT DE SOL DOUCHES
Matériau qui convient aux sols de douche.



SHOWER WALL COVERING
Material suitable for use on shower walls.
REVESTIMIENTO DUCHAS
Material apto para su uso en paredes de ducha.
REVÊTEMENT DOUCHES
Matériau qui convient aux murs de douches.

Marble Mármol Marbre

—

Blanco Almeria
Persian White
Blanco Carrara
Arctic White
Capadocia
Kayak Beige
Crema Grecia
Capuccino
Nairobi Crema
Nairobi Grey
Capuccino Grey
Habana Brown
Habana Grey
Habana Dark
Caspian Grey



01

Marble / Mármol / Marbre



Blanco Almeria Anticato

- 
BIOPROT
- 
MATT
- 
MODERATE
COLOR
VARIATION
- 
ORIGIN
EUROPE
- 
INDOOR
FLOORING
- 
INDOOR
WALL
COVERING
- 
OUTDOOR
WALL
COVERING
- 
SHOWER
WALL
COVERINGS
- 
COUNTER
TOPS
- 
RAMP
CLASSIFICATION

Description	Format	Codes	Group	Pcs	m2	Kg
Blanco Almeria Anticato	30x60x1,2cm 11 3/4"x23 5/8"x1/2"	100000179 L112971001	G-242	4 x Cj 176 x Pal	0,72 x Cj 31,68 x Pal	23,16 x Cj 1019,22 x Pal

Butech: Colorstuk Rapid Blanco



Floor Coverings Blanco Almeria Anticato / Wall Coverings Gravity Aluminium Cubic Gold

Marble / Mármol / Marbre



Persian White Pulido



Butech: Colorstuk Rapid Blanco

Description	Format	Codes	Group	Pcs	m2	Kg
Persian White Pulido	9,8x30x1,5cm 3 7/8"x11 3/4"x5/8"	100149005 L108027041	G-265	13 x Cj 780 x Pal	0,38 x Cj 22,93 x Pal	16,55 x Cj 992,94 x Pal
Persian White Pulido	30x60x1,5cm 11 3/4"x23 5/8"x5/8"	100102697 L119294131	G-260	3 x Cj 132 x Pal	0,54 x Cj 23,76 x Pal	23,39 x Cj 1029,34 x Pal
Persian White Pulido	40x80x2cm 15 3/4"x31 1/2"x3/4"	100142942 L108025901	G-268	1 x Cj 78 x Pal	0,32 x Cj 24,96 x Pal	18,48 x Cj 1441,67 x Pal
Persian White Pulido	60x60x2cm 23 5/8"x23 5/8"x3/4"	100098384 L100200191	G-268	1 x Cj 40 x Pal	0,36 x Cj 14,40 x Pal	20,80 x Cj 831,80 x Pal
Slab / Tabla / Tranche	2cm 3/4"	100155542 L108029771	G-260	-	-	-
Slab / Tabla / Tranche	3cm 1 1/8"	100155543 L108029781	G-270	-	-	-

STOCK

STOCK



Persian White Classico



Butech: Colorstuk Rapid Blanco

Description	Format	Codes	Group	Pcs	m2	Kg
Persian White Classico	9,8x30x1,5cm 3 7/8"x11 3/4"x5/8"	100149004 L108027021	G-265	13 x Cj 780 x Pal	0,38 x Cj 22,93 x Pal	16,18 x Cj 971,10 x Pal
Persian White Classico	30x60x1,5cm 11 3/4"x23 5/8"x5/8"	100142837 L112995691	G-260	3 x Cj 132 x Pal	0,54 x Cj 23,76 x Pal	23,39 x Cj 1029,07 x Pal
Persian White Classico	40x80x2cm 15 3/4"x31 1/2"x3/4"	100142941 L108025891	G-268	1 x Cj 78 x Pal	0,32 x Cj 24,96 x Pal	18,47 x Cj 1440,66 x Pal
Persian White Classico	60x60x2cm 23 5/8"x23 5/8"x3/4"	100142838 L116688241	G-268	1 x Cj 40 x Pal	0,36 x Cj 14,40 x Pal	20,78 x Cj 831,20 x Pal
Slab / Tabla / Tranche	2cm 3/4"	100155540 L108029741	G-260	-	-	-
Slab / Tabla / Tranche	3cm 1 1/8"	100155541 L108029731	G-270	-	-	-

STOCK

01

Marble / Mármol / Marbre



Blanco Carrara Pulido



Description	Format	Codes	Group	Pcs	m2	Kg
Blanco Carrara Pulido	9,8x30x1,5cm	100213831	G-279	13 x Cj	0,38 x Cj	16,54 x Cj
	3 7/8"x11 3/4"x5/8"	L108047661		780 x Pal	22,93 x Pal	992,94 x Pal
Blanco Carrara Pulido	30x60x1,5cm	100213813	G-270	3 x Cj	0,54 x Cj	23,39 x Cj
	11 3/4"x23 5/8"x5/8"	L112996481		132 x Pal	23,76 x Pal	1029,33 x Pal
Blanco Carrara Pulido	60x60x1,5cm	100213830	G-276	1 x Cj	0,36 x Cj	15,59 x Cj
	23 5/8"x23 5/8"x5/8"	L100200711		40 x Pal	14,40 x Pal	623,84 x Pal

NEW

Butech: Colorstuk Rapid Blanco



Blanco Carrara Classico



Description	Format	Codes	Group	Pcs	m2	Kg
Blanco Carrara Classico	9,8x30x1,5cm	100213779	G-279	13 x Cj	0,38 x Cj	16,54 x Cj
	3 7/8"x11 3/4"x5/8"	L108047651		780 x Pal	22,93 x Pal	992,94 x Pal
Blanco Carrara Classico	30x60x1,5cm	100213769	G-270	3 x Cj	0,54 x Cj	23,39 x Cj
	11 3/4"x23 5/8"x5/8"	L112996491		132 x Pal	23,76 x Pal	1029,33 x Pal
Blanco Carrara Classico	60x60x1,5cm	100213812	G-276	1 x Cj	0,36 x Cj	15,59 x Cj
	23 5/8"x23 5/8"x5/8"	L116688471		40 x Pal	14,40 x Pal	623,84 x Pal

NEW

Butech: Colorstuk Rapid Blanco

Marble / Mármol / Marbre



Arctic White Pulido



Butech: Colorstuk Rapid Blanco

Description	Format	Codes	Group	Pcs	m2	Kg
Arctic White Pulido	9,8x30x1,5cm	100148978	G-265	13 x Cj	0,38 x Cj	16,95 x Cj
	3 7/8"x11 3/4"x5/8"	L108026981		780 x Pal	22,93 x Pal	1017,12 x Pal
Arctic White Pulido	30x60x1,5cm	100146821	G-260	3 x Cj	0,54 x Cj	23,10 x Cj
	11 3/4"x23 5/8"x5/8"	L119294201		132 x Pal	23,76 x Pal	1016,40 x Pal
Arctic White Pulido	40x80x1,5cm	100146008	G-263	1 x Cj	0,32 x Cj	11,32 x Cj
	15 3/4"x31 1/2"x5/8"	L108026371		78 x Pal	24,96 x Pal	883,04 x Pal
Slab / Tabla / Tranche	2cm	100155457	G-255	-	-	-
	3/4"	L108029471		-	-	-
Slab / Tabla / Tranche	3cm	100155458	G-268	-	-	-
	1 1/8"	L108029521		-	-	-



Arctic White Classico



Butech: Colorstuk Rapid Blanco

Description	Format	Codes	Group	Pcs	m2	Kg
Arctic White Classico	9,8x30x1,5cm	100149011	G-265	13 x Cj	0,38 x Cj	16,95 x Cj
	3 7/8"x11 3/4"x5/8"	L108027081		780 x Pal	22,93 x Pal	1017,12 x Pal
Arctic White Classico	30x60x1,5cm	100168106	G-260	3 x Cj	0,54 x Cj	23,96 x Cj
	11 3/4"x23 5/8"x5/8"	L112995791		132 x Pal	23,76 x Pal	1054,28 x Pal
Arctic White Classico	40x80x1,5cm	100168185	G-263	1 x Cj	0,32 x Cj	14,20 x Cj
	15 3/4"x31 1/2"x5/8"	L108035271		78 x Pal	24,96 x Pal	1107,60 x Pal
Slab / Tabla / Tranche	2cm	100168194	G-244	-	-	-
	3/4"	L108035281		-	-	-
Slab / Tabla / Tranche	3cm	100168205	G-257	-	-	-
	1 1/8"	L108035301		-	-	-

01

Marble / Mármol / Marbre



Capadocia Sand Home



Description	Format	Codes	Group	Pcs	m2	Kg	Butech: Colorstuk Rapid Blanco
Capadocia Sand Home	30x60x1,2cm 11 3/4"x23 5/8"x1/2"	100114124 L108020551	G-272	4 x Cj 176 x Pal	0,72 x Cj 31,68 x Pal	25 x Cj 1100,18 x Pal	



Floor Coverings Linkfloor Hotel Air Mist / Wall Coverings Capadocia Sand Home, Diverse Grey / Complementary Products Essence Habana Dark Classico

Marble / Mármol / Marbre



Kayak Beige Pulido



Butech: Colorstuk Rapid Marfil

Description	Format	Codes	Group	Pcs	m2	Kg
Kayak Beige Pulido	30x60x1cm	100156153	G-267	4 x Cj	0,72 x Cj	17,63 x Cj
	11 3/4"x23 5/8"x3/8"	L119294241		176 x Pal	31,68 x Pal	775,98 x Pal
Kayak Beige Pulido	40x80x1cm	100156154	G-270	1 x Cj	0,32 x Cj	8,94 x Cj
	15 3/4"x31 1/2"x3/8"	L108029991		78 x Pal	24,96 x Pal	697,47 x Pal
Kayak Beige Pulido	60x60x1cm	100156155	G-275	2 x Cj	0,72 x Cj	20,12 x Cj
	23 5/8"x23 5/8"x3/8"	L100200481		92 x Pal	33,12 x Pal	925,52 x Pal
Slab / Tabla / Tranche	2cm	100156156	G-279	-	-	-
	3/4"	L108029981		-	-	-
Slab / Tabla / Tranche	3cm	100156157	G-282	-	-	-
	1 1/8"	L108029971		-	-	-



Kayak Beige Classico



Butech: Colorstuk Rapid Marfil

Description	Format	Codes	Group	Pcs	m2	Kg
Kayak Beige Classico	30x60x1cm	100161161	G-267	4 x Cj	0,72 x Cj	18,97 x Cj
	11 3/4"x23 5/8"x3/8"	L112995781		176 x Pal	31,68 x Pal	834,94 x Pal
Kayak Beige Classico	40x80x1cm	100161170	G-270	2 x Cj	0,64 x Cj	16,86 x Cj
	15 3/4"x31 1/2"x3/8"	L108032831		156 x Pal	49,92 x Pal	1315,70 x Pal
Kayak Beige Classico	60x60x1cm	100173382	G-275	2 x Cj	0,72 x Cj	18,97 x Cj
	23 5/8"x23 5/8"x3/8"	L116688361		92 x Pal	33,12 x Pal	872,89 x Pal
Slab / Tabla / Tranche	2cm	100161179	G-279	-	-	-
	3/4"	L108032761		-	-	-
Slab / Tabla / Tranche	3cm	100161084	G-282	-	-	-
	1 1/8"	L108032711		-	-	-

01

Marble / Mármol / Marbre



Crema Grecia Anticato



Description	Format	Codes	Group	Pcs	m2	Kg
Crema Grecia Anticato	30x60x1,2cm 11 3/4"x23 5/8"x1/2"	100000184 L112982001	G-252	4 x Cj 176 x Pal	0,72 x Cj 31,68 x Pal	25 x Cj 1100,18 x Pal

STOCK

Butech: Colorstuk Rapid Beige



Crema Grecia Classico



Description	Format	Codes	Group	Pcs	m2	Kg
Crema Grecia Classico	9,8x30x1,2cm 3 7/8"x11 3/4"x1/2"	100202967 L108045031	G-265	16 x Cj 960 x Pal	0,47 x Cj 28,22 x Pal	15,82 x Cj 949,44 x Pal
Crema Grecia Classico	30x60x1,2cm 11 3/4"x23 5/8"x1/2"	100000188 L112992001	G-267	4 x Cj 176 x Pal	0,72 x Cj 31,68 x Pal	24 x Cj 1056 x Pal
Crema Grecia Classico	40x80x1,5cm 15 3/4"x31 1/2"x5/8"	100082211 L108008941	G-275	1 x Cj 78 x Pal	0,32 x Cj 24,96 x Pal	11,50 x Cj 897 x Pal
Crema Grecia Classico	60x60x2cm 23 5/8"x23 5/8"x3/4"	100003812 L113098021	G-276	1 x Cj 40 x Pal	0,36 x Cj 14,40 x Pal	20 x Cj 800 x Pal
Slab / Tabla / Tranche	2cm 3/4"	100155525 L108029541	G-276	-	-	-
Slab / Tabla / Tranche	3cm 1 1/8"	100155526 L108029511	G-283	-	-	-

NEW

STOCK

Butech: Colorstuk Rapid Beige

Marble / Marmol / Marbre



Crema Grecia Pulido



Butech: Colorstuk Rapid Beige

Description	Format	Codes	Group	Pcs	m2	Kg
Crema Grecia Pulido	30x60x1,2cm	100179149	G-267	4 x Cj	0,72 x Cj	23,51 x Cj
	11 3/4"x23 5/8"x1/2"	L119294301		176 x Pal	31,68 x Pal	1034,35 x Pal
Crema Grecia Pulido	40x80x1,5cm	100179165	G-275	1 x Cj	0,32 x Cj	13,06 x Cj
	15 3/4"x31 1/2"x5/8"	L108038331		78 x Pal	24,96 x Pal	1018,60 x Pal
Crema Grecia Pulido	60x60x2cm	100179175	G-276	1 x Cj	0,36 x Cj	19,59 x Cj
	23 5/8"x23 5/8"x3/4"	L100200621		40 x Pal	14,4 x Pal	783,56 x Pal
Tabla Crema Grecia Pulido	2cm	100179366	G-276	-	-	-
	3/4"	L108038491		-	-	-
Tabla Crema Grecia Pulido	3cm	100179356	G-283	-	-	-
	1 1/8"	L108038501		-	-	-



Floor Coverings Crema Grecia Pulido / **Wall Coverings** Crema Grecia Classico, Classic Espiga Natura / **Complementary Products** Vintage S Crema Italia/Negro, Vintage Espejo S Negro

01

Marble / Mármol / Marbre



Capuccino Pulido



Description	Format	Codes	Group	Pcs	m2	Kg
Capuccino Pulido	30x60x1,2cm	100000160	G-252	4 x Cj	0,72 x Cj	24,09 x Cj
	11 3/4"x23 5/8"x1/2"	L112925161		176 x Pal	31,68 x Pal	1060,05 x Pal
Capuccino Pulido	60x60x2cm	100000462	G-265	1 x Cj	0,36 x Cj	21,34 x Cj
	23 5/8"x23 5/8"x3/4"	L116686001		40 x Pal	14,40 x Pal	853,52 x Pal
Slab / Tabla / Tranche	2cm	100155523	G-268	-	-	-
	3/4"	L108029481		-	-	-
Slab / Tabla / Tranche	3cm	100155524	G-279	-	-	-
	1 1/8"	L108029551		-	-	-

Butech: Colorstuk Rapid Beige



Capuccino Sand Home



Description	Format	Codes	Group	Pcs	m2	Kg
Capuccino Sand Home	30x60x1,5cm	100114602	G-268	3 x Cj	0,54 x Cj	17,82 x Cj
	11 3/4"x23 5/8"x5/8"	L108020741		132 x Pal	23,76 x Pal	784,08 x Pal
Capuccino Sand Home	40x80x1,5cm	100096778	G-270	1 x Cj	0,32 x Cj	13,22 x Cj
	15 3/4"x31 1/2"x5/8"	L108015071		78 x Pal	24,96 x Pal	1031 x Pal

Butech: Colorstuk Rapid Beige

Marble / Marmol / Marbre



Nairobi Crema Pulido



Description	Format	Codes	Group	Pcs	m2	Kg
Nairobi Crema Pulido	30x60x1,2cm	100045556	G-260	4 x Cj	0,72 x Cj	24,22 x Cj
	11 3/4"x23 5/8"x1/2"	L100300071		132 x Pal	31,68 x Pal	1065,68 x Pal
Nairobi Crema Pulido	40x80x1,5cm	100073337	G-267	1 x Cj	0,32 x Cj	11,50 x Cj
	15 3/4"x31 1/2"x5/8"	L108006921		78 x Pal	24,96 x Pal	897 x Pal
Nairobi Crema Pulido	60x60x1,5cm	100045557	G-267	1 x Cj	0,36 x Cj	15,71 x Cj
	23 5/8"x23 5/8"x5/8"	L100300081		40 x Pal	14,40 x Pal	628,52 x Pal
Slab / Tabla / Tranche	2cm	100155508	G-265	-	-	-
	3/4"	L108029701		-	-	-
Slab / Tabla / Tranche	3cm	100155509	G-272	-	-	-
	1 1/8"	L108029721		-	-	-

STOCK

Butech: Colorstuk Rapid Marfil



Nairobi Crema Classico



Description	Format	Codes	Group	Pcs	m2	Kg
Nairobi Crema Classico	30x60x1,2cm	100089719	G-260	4 x Cj	0,72 x Cj	24,22 x Cj
	11 3/4"x23 5/8"x1/2"	L112995351		176 x Pal	31,68 x Pal	1065,68 x Pal
Nairobi Crema Classico	40x80x1,5cm	100089720	G-267	1 x Cj	0,32 x Cj	13,20 x Cj
	15 3/4"x31 1/2"x5/8"	L108011571		78 x Pal	24,96 x Pal	1029,6 x Pal
Nairobi Crema Classico	60x60x1,5cm	100098366	G-267	1 x Cj	0,36 x Cj	14,72 x Cj
	23 5/8"x23 5/8"x5/8"	L116688121		40 x Pal	14,40 x Pal	588,92 x Pal
Slab / Tabla / Tranche	2cm	100155506	G-265	-	-	-
	3/4"	L108029711		-	-	-
Slab / Tabla / Tranche	3cm	100155507	G-272	-	-	-
	1 1/8"	L108029761		-	-	-

Butech: Colorstuk Rapid Marfil



Nairobi Grey Pulido



Description	Format	Codes	Group	Pcs	m2	Kg
Nairobi Grey Pulido	30x60x1,2cm	100214518	G-260	4 x Cj	0,72 x Cj	21,21 x Cj
	11 3/4"x23 5/8"x1/2"	L119294341		176 x Pal	31,68 x Pal	933,50 x Pal
Nairobi Grey Pulido	40x80x1,5cm	100214550	G-276	1 x Cj	0,32 x Cj	12,74 x Cj
	15 3/4"x31 1/2"x5/8"	L108047711		78 x Pal	24,96 x Pal	993,56 x Pal
Slab / Tabla / Tranche	2cm	100214519	G-279	-	-	-
	3/4"	L108047701		-	-	-

NEW

Butech: Colorstuk Rapid Gris



Nairobi Grey Classico



Description	Format	Codes	Group	Pcs	m2	Kg
Nairobi Grey Classico	30x60x1,2cm	100214499	G-260	4 x Cj	0,72 x Cj	21,21 x Cj
	11 3/4"x23 5/8"x1/2"	L112996501		176 x Pal	31,68 x Pal	933,50 x Pal
Nairobi Grey Classico	40x80x1,5cm	100214517	G-276	1 x Cj	0,32 x Cj	12,74 x Cj
	15 3/4"x31 1/2"x5/8"	L108047691		78 x Pal	24,96 x Pal	993,56 x Pal
Slab / Tabla / Tranche	2cm	100214551	G-279	-	-	-
	3/4"	L108047871		-	-	-

NEW

Butech: Colorstuk Rapid Gris

Marble / Mármol / Marbre



Capuccino Grey Pulido



Butech: Colorstuk Rapid Cemento

Description	Format	Codes	Group	Pcs	m2	Kg
Capuccino Grey Pulido	30x60x1,5cm	100161181	G-268	3 x Cj	0,54 x Cj	15,21 x Cj
	11 3/4"x23 5/8"x5/8"	L119294261		132 x Pal	23,76 x Pal	669,50 x Pal
Capuccino Grey Pulido	40x80x1,5cm	100161149	G-275	1 x Cj	0,32 x Cj	9,01 x Cj
	15 3/4"x31 1/2"x5/8"	L108032821		78 x Pal	24,96 x Pal	703,32 x Pal
Capuccino Grey Pulido	60x60x1,5cm	100161160	G-276	1 x Cj	0,36 x Cj	10,14 x Pal
	23 5/8"x23 5/8"x5/8"	L100200541		40 x Pal	14,4 x Pal	405,80 x Cj
Slab / Tabla / Tranche	2cm	100161177	G-268	-	-	-
	3/4"	L108032771		-	-	-
Slab / Tabla / Tranche	3cm	100161178	G-279	-	-	-
	1 1/8"	L108032751		-	-	-



Capuccino Grey Classico



Butech: Colorstuk Rapid Cemento

Description	Format	Codes	Group	Pcs	m2	Kg
Capuccino Grey Classico	30x60x1,5cm	100161180	G-268	3 x Cj	0,54 x Cj	15,21 x Cj
	11 3/4"x23 5/8"x5/8"	L112995771		132 x Pal	23,76 x Pal	669,50 x Pal
Capuccino Grey Classico	40x80x1,5cm	100161146	G-275	1 x Cj	0,32 x Cj	9,01 x Cj
	15 3/4"x31 1/2"x5/8"	L108032811		78 x Pal	24,96 x Pal	703,32 x Pal
Capuccino Grey Classico	60x60x1,5cm	100161147	G-276	1 x Cj	0,36 x Cj	10,14 x Pal
	23 5/8"x23 5/8"x5/8"	L116688291		40 x Pal	14,4 x Pal	405,80 x Cj
Slab / Tabla / Tranche	2cm	100161175	G-268	-	-	-
	3/4"	L108032731		-	-	-
Slab / Tabla / Tranche	3cm	100161176	G-279	-	-	-
	1 1/8"	L108032741		-	-	-



Habana Brown Pulido



Description	Format	Codes	Group	Pcs	m2	Kg
Habana Brown Pulido	30x60x1,2cm	100001541	G-257	4 x Cj	0,72 x Cj	24,84 x Cj
	11 3/4"x23 5/8"x1/2"	L150501001		176 x Pal	31,68 x Pal	1092,96 x Pal
Habana Brown Pulido	40x80x1,5cm	100073336	G-270	1 x Cj	0,32 x Cj	13,64 x Cj
	15 3/4"x31 1/2"x5/8"	L108006911		78 x Pal	24,96 x Pal	1064 x Pal
Slab / Tabla / Tranche	2cm	100155533	G-272	-	-	-
	3/4"	L108029571		-	-	-
Slab / Tabla / Tranche	3cm	100155534	G-279	-	-	-
	1 1/8"	L108029661		-	-	-

Butech: Colorstuk Rapid Antracita



Habana Brown Classico



Description	Format	Codes	Group	Pcs	m2	Kg
Habana Brown Classico	30x60x1,2cm	100092925	G-257	4 x Cj	0,72 x Cj	24,84 x Cj
	11 3/4"x23 5/8"x1/2"	L112995361		176 x Pal	31,68 x Pal	1092,96 x Pal
Habana Brown Classico	40x80x1,5cm	100092715	G-270	1 x Cj	0,32 x Cj	13,06
	15 3/4"x31 1/2"x5/8"	L108012931		78 x Pal	24,96 x Pal	1019 x Pal
Slab / Tabla / Tranche	2cm	100155531	G-272	-	-	-
	3/4"	L108029611		-	-	-
Slab / Tabla / Tranche	3cm	100155532	G-279	-	-	-
	1 1/8"	L108029591		-	-	-

Butech: Colorstuk Rapid Antracita

Marble / Mármol / Marbre

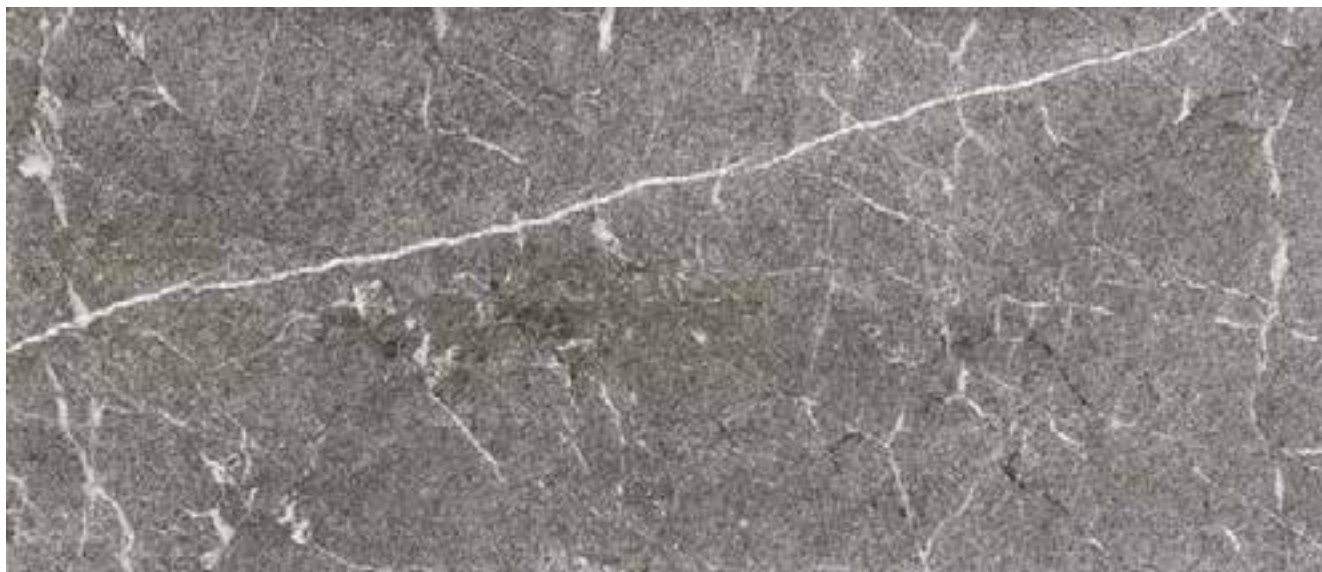

Habana Brown Sand Home

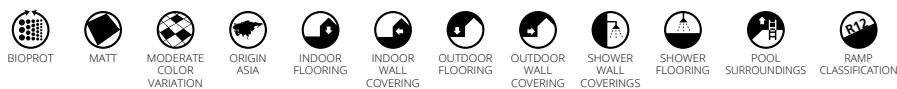

Description	Format	Codes	Group	Pcs	m2	Kg
Habana Brown Sand Home	30x60x1,5cm	100115881	G-272	3 x Cj	0,54 x Cj	23,29 x Cj
	11 3/4"x23 5/8"x5/8"	L108021111		132 x Pal	23,76 x Pal	1024,58 x Pal
Habana Brown Sand Home	40x80x1,5cm	100096784	G-275	1 x Cj	0,32 x Cj	13,44 x Cj
	15 3/4"x31 1/2"x5/8"	L108015081		78 x Pal	24,96 x Pal	1048 x Pal

Butech: Colorstuk Rapid Manhattan



Floor Coverings Habana Brown Sand Home / Wall Coverings Habana Brown Sand Home



Habana Grey Pulido



Description	Format	Codes	Group	Pcs	m2	Kg
Habana Grey Pulido	30x60x1,2cm	100168313	G-260	4 x Cj	0,72 x Cj	23,18 x Cj
	11 3/4"x23 5/8"x1/2"	L119294271		176 x Pal	31,68 x Pal	1019,92 x Pal
Habana Grey Pulido	40x80x1,5cm	100168309	G-268	1 x Cj	0,32 x Cj	13,06 x Cj
	15 3/4"x31 1/2"x5/8"	L108035361		78 x Pal	24,96 x Pal	1018,99 x Pal
Slab / Tabla / Tranche	2cm	100176336	G-272	-	-	-
	3/4"	L108037361		-	-	-
Slab / Tabla / Tranche	3cm	100176327	G-279	-	-	-
	1 1/8"	L108037371		-	-	-

Butech: Colorstuk Rapid Cemento



Habana Grey Classico



Description	Format	Codes	Group	Pcs	m2	Kg
Habana Grey Classico	9,8x30x1,2cm	100202969	G-257	16 x Cj	0,47 x Cj	15,42 x Cj
	3 7/8"11 3/4"x1/2"	L108045021		960 x Pal	28,22 x Pal	925,44 x Pal
Habana Grey Classico	30x60x1,2cm	100168312	G-260	4 x Cj	0,72 x Cj	23,18 x Cj
	11 3/4"x23 5/8"x1/2"	L112995841		176 x Pal	31,68 x Pal	1019,92 x Pal
Habana Grey Classico	40x80x1,5cm	100168308	G-268	1 x Cj	0,32 x Cj	13,06 x Cj
	15 3/4"x31 1/2"x5/8"	L108035351		78 x Pal	24,96 x Pal	1018,99 x Pal
Slab / Tabla / Tranche	2cm	100176351	G-272	-	-	-
	3/4"	L108037341		-	-	-
Slab / Tabla / Tranche	3cm	100176347	G-279	-	-	-
	1 1/8"	L108037351		-	-	-

NEW

Butech: Colorstuk Rapid Cemento

Marble / Mármol / Marbre



Habana Dark Pulido



Description	Format	Codes	Group	Pcs	m2	Kg
Habana Dark Pulido	30x60x1,5cm	100086382	G-270	3 x Cj	0,54 x Cj	21,89 x Cj
	11 3/4"x23 5/8"x5/8"	L119294091		132 x Pal	23,76 x Pal	963,20 x Pal
Habana Dark Pulido	40x80x1,5cm	100086383	G-275	1 x Cj	0,32 x Cj	13,79 x Cj
	15 3/4"x31 1/2"x5/8"	L108010481		78 x Pal	24,96 x Pal	1076 x Pal
Habana Dark Pulido	60x60x1,5cm	100177669	G-276	1 x Cj	0,36 x Cj	19,46 x Cj
	23 5/8"x23 5/8"x5/8"	L100200611		40 x Pal	14,40 x Pal	778,32 x Pal
Slab / Tabla / Tranche	2cm	100155502	G-272	-	-	-
	3/4"	L108029671		-	-	-
Slab / Tabla / Tranche	3cm	100155503	G-282	-	-	-
	1 1/8"	L108029691		-	-	-

Butech: Colorstuk Rapid Antracita



Habana Dark Classico



Description	Format	Codes	Group	Pcs	m2	Kg
Habana Dark Classico	9,8x30x1,5cm	100202968	G-265	13 x Cj	0,38 x Cj	16,53 x Cj
	3 7/8"x11 3/4"x5/8"	L108045011		780 x Pal	22,93 x Pal	992,16 x Pal
Habana Dark Classico	30x60x1,5cm	100171865	G-270	3 x Cj	0,54 x Cj	21,89 x Cj
	11 3/4"x23 5/8"x5/8"	L112996261		132 x Pal	23,76 x Pal	963,20 x Pal
Habana Dark Classico	40x80x1,5cm	100171866	G-275	1 x Cj	0,32 x Cj	13,79 x Cj
	15 3/4"x31 1/2"x5/8"	L108036571		78 x Pal	24,96 x Pal	1076 x Pal
Habana Dark Classico	60x60x1,5cm	100177693	G-276	1 x Cj	0,36 x Cj	19,46 x Cj
	23 5/8"x23 5/8"x5/8"	L116688381		40 x Pal	14,40 x Pal	778,32 x Pal
Slab / Tabla / Tranche	2cm	100155535	G-272	-	-	-
	3/4"	L108029631		-	-	-
Slab / Tabla / Tranche	3cm	100155536	G-282	-	-	-
	1 1/8"	L108029581		-	-	-

Butech: Colorstuk Rapid Antracita

NEW

STOCK

01

Marble / Mármol / Marbre



Caspian Grey Pulido



Butech: Colorstuk Rapid Antracita

Description	Format	Codes	Group	Pcs	m2	Kg
Caspian Grey Pulido	30x60x1,5cm	100203092	G-263	3 x Cj	0,54 x Cj	23,28 x Cj
	11 3/4"x23 5/8"x5/8"	L119294311		132 x Pal	23,76 x Pal	1024,58 x Pal
Caspian Grey Pulido	40x80x1,5cm	100203102	G-267	1 x Cj	0,32 x Cj	13,76 x Cj
	15 3/4"x31 1/2"x5/8"	L108045001		78 x Pal	24,96 x Pal	1073,67 x Pal
Slab / Tabla / Tranche	2cm	100203127	G-270	-	-	-
	3/4"	L108044971		-	-	-

NEW



Floor Coverings Caspian Grey Pulido, Elite Lava Stone Mix Gold Silver





Travertine Travertino Travertin

Moka
Toscano
Silver Wood
Silk Wood
Ocean Wood

01

Travertine / Travertino / Travertin



Moka Anticato



Description	Format	Codes	Group	Pcs	m2	Kg
Moka Anticato	30x60x1,2cm 11 3/4"x23 5/8"x1/2"	100000183 L112981001	G-246	4 x Cj 176 x Pal	0,72 x Cj 31,68 x Pal	23,16 x Cj 1019,22 x Pal

Butech: Colorstuk Rapid Beige



Moka Classico



Description	Format	Codes	Group	Pcs	m2	Kg
Moka Classico	30x60x1,2cm 11 3/4"x23 5/8"x1/2"	100000187 L112991001	G-257	4 x Cj 176 x Pal	0,72 x Cj 31,68 x Pal	21,03 x Cj 925,41 x Pal
Moka Classico	40x80x1,5cm 15 3/4"x31 1/2"x5/8"	100073340 L108006961	G-268	1 x Cj 78 x Pal	0,32 x Cj 24,96 x Pal	12,65 x Cj 997 x Pal
Moka Classico	60x60x2cm 23 5/8"x23 5/8"x3/4"	100000456 L116661501	G-275	1 x Cj 40 x Pal	0,36 x Cj 14,40 x Pal	17,87 x Cj 714,84 x Pal
Slab / Tabla / Tranche	2cm 3/4"	100155504 L108029751	G-270	-	-	-
Slab / Tabla / Tranche	3cm 1 1/8"	100155505 L108029681	G-279	-	-	-

Butech: Colorstuk Rapid Marfil

Travertine / Travertino / Travertin

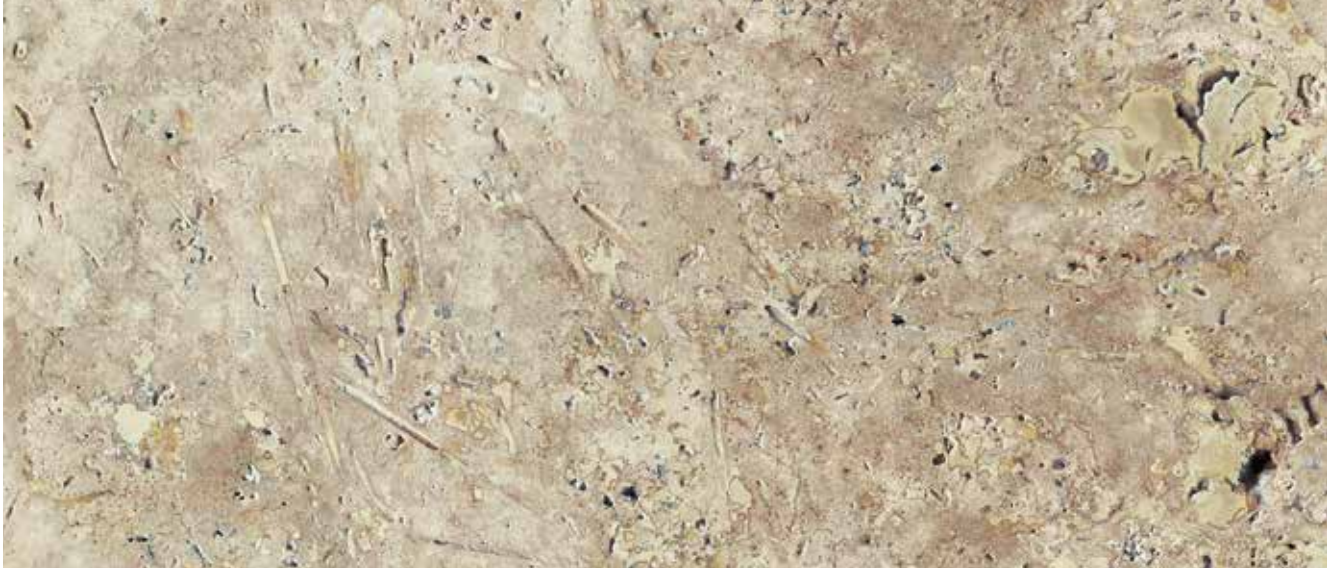

Toscano Anticato



Description	Format	Codes	Group	Pcs	m2	Kg
Toscano Anticato	Multiformat / Multiformato / Multiformat	100107322 L107600221	G-242	1 x Cj 23 x Pal	0,72 x Cj 16,56 x Pal	23,57 x Cj 542,20 x Pal

MULTIFORMAT / MULTIFORMATO / MULTIFORMAT

Packet is served. 0,72 m2 per pack. composed of 40,6x40,6x1,2 (2pzs.). 20x20x1,2 (2pzs.). 40,6x61,2x1,2 (1pzs.). 20x40,6x1,2 (1pzs.) / Se sirve por paquetes. 0,72 m² por paquete. compuesto por 40,6x40,6x1,2 (2pzs.). 20x20x1,2 (2pzs.). 40,6x61,2x1,2 (1pzs.). 20x40,6x1,2 (1pzs.) / Paquet est servi. 0,72 m² par paquet. composé de 40,6x40,6x1,2 (2pzs.). 20x20x1,2 (2pzs.). 40,6x61,2x1,2 (1pzs.). 20x40,6x1,2 (1pzs.)

Butech: Colorstuk Rapid Beige

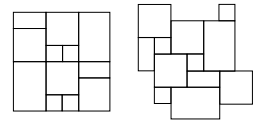

SUGGESTED LAYOUTS EJEMPLOS COLOCACIÓN EXEMPLES DE POSE



Floor Coverings Multiformato Toscano Anticato



Silver Wood Classico

- BIOPROT
- MATT
- MODERATE COLOR VARIATION
- BEVEL (*EXCEPT 10x25)
- ORIGIN ASIA
- INDOOR FLOORING
- INDOOR WALL COVERING
- OUTDOOR WALL COVERING
- SHOWER WALL COVERINGS
- COUNTERTOPS
- RAMP CLASSIFICATION

Description	Format	Codes	Group	Pcs	m2	Kg
Silver Wood Classico	7,5x30x1,2cm 3"x11 3/4"x1/2"	100116171 L108021211	G-270	24 x Cj 2040 x Pal	0,54 x Cj 45,90 x Pal	17,97 x Cj 1527,96 x Pal
Silver Wood Classico	10x25x1cm	100213796	G-268	16 x Cj 960 x Pal	0,31 x Cj 18,43 x Pal	9,04 x Cj 542,40 x Pal
Silver Wood Classico	3 7/8"x9 7/8"x3/8"	L107603151	G-270	8 x Cj 480 x Pal	0,48 x Cj 28,80 x Pal	15,69 x Cj 941,76 x Pal
Silver Wood Classico	10x60x1,2cm 3 7/8"x23 5/8"x1/2"	100116170 L108021221	G-270	4 x Cj 176 x Pal	0,73 x Cj 32 x Pal	22,48 x Cj 989,12 x Pal
Silver Wood Classico	40x80x1,5cm 15 3/4"x31 1/2"x5/8"	100114132 L108020501	G-265	1 x Cj 78 x Pal	0,32 x Cj 24,96 x Pal	12,93 x Cj 1008,15 x Pal

NEW
STOCK

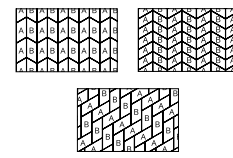

10x25 SUGGESTED LAYOUT
EJEMPLO COLOCACIÓN 10x25
EXEMPLE DE POSE 10x25

Butech: Colorstuk Rapid Gris

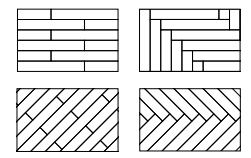

10x60 SUGGESTED LAYOUT
EJEMPLO COLOCACIÓN 10x60
EXEMPLE DE POSE 10x60



Floor Coverings Silver Wood Classico / **Wall Coverings** Silver Wood Classico / **Complementary Products** Men(H)ir Crema Italia Classico, Men(H)ir Encimera L Roble Antracita, Men(H)ir Mueble L Crema Italia-Roble Antracita, Men(H)ir Espejo Roble Antracita, Men(H)ir Estante Vertical I Roble Antracita

Travertine / Travertino / Travertin



Silk Wood Classico



Description	Format	Codes	Group	Pcs	m2	Kg
Silk Wood Classico	10x25x1cm 3 7/8"x9 7/8"x3/8"	100213823 L107603131	G-268	16 x Cj 960 x Pal	0,31 x Cj 18,43 x Pal	9,04 x Cj 542,40 x Pal
Silk Wood Classico	10x60x1,2cm 3 7/8"x23 5/8"x1/2"	100213824 L107603141	G-270	8 x Cj 480 x Pa	0,48 x Cj 28,80 x Pal	16,25 x Cj 974,88 x Pal
Silk Wood Classico	30x60x1,2cm 11 3/4"x23 5/8"x1/2"	100120899 L112995651	G-270	4 x Cj 176 x Pal	0,72 x Cj 31,68 x Pal	23,66 x Cj 1041,22 x Pal
Silk Wood Classico	40x80x1,5cm 15 3/4"x31 1/2"x5/8"	100120900 L108021961	G-276	1 x Cj 78 x Pal	0,32 x Cj 24,96 x Pal	12,91 x Cj 1007,45 x Pal

NEW

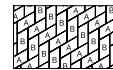
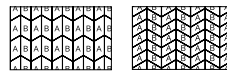

10x25 SUGGESTED LAYOUT
EJEMPLO COLOCACIÓN 10x25
EXEMPLE DE POSE 10x25

Butech: Colorstuk Rapid Gris

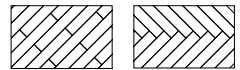
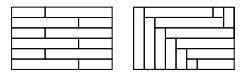

10x60 SUGGESTED LAYOUT
EJEMPLO COLOCACIÓN 10x60
EXEMPLE DE POSE 10x60



Floor Coverings Silk Wood Classico / Wall Coverings Silver Wood Classico, Aichi Mix Wood



Ocean Wood Classico



Description	Format	Codes	Group	Pcs	m2	Kg
Ocean Wood Classico	10x25x1cm 3 7/8"x9 7/8"x3/8"	100213814 L107603121	G-268	16 x Cj 960 x Pal	0,31 x Cj 18,43 x Pal	9,04 x Cj 542,40 x Pal
Ocean Wood Classico	10x60x1,2cm 3 7/8"x23 5/8"x1/2"	100213802 L107603111	G-270	8 x Cj 480 x Pal	0,48 x Cj 28,80 x Pal	16,25 x Cj 974,88 x Pal
Ocean Wood Classico	30x60x1,2cm 11 3/4"x23 5/8"x1/2"	100213840 L107603101	G-260	4 x Cj 176 x Pal	0,72 x Cj 31,68 x Pal	24,37 x Cj 1072,19 x Pal
Ocean Wood Classico	40x80x1,5cm 15 3/4"x31 1/2"x5/8"	100213841 L107603091	G-265	1 x Cj 78 x Pal	0,32 x Cj 24,96 x Pal	12,98 x Cj 1012,21 x Pal

NEW

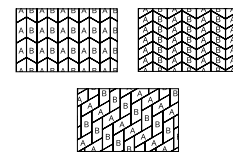

10x25 SUGGESTED LAYOUT
EJEMPLO COLOCACIÓN 10x25
EXEMPLE DE POSE 10x25

Butech: Colorstuk Rapid Gris

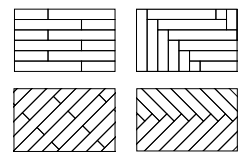

10x60 SUGGESTED LAYOUT
EJEMPLO COLOCACIÓN 10x60
EXEMPLE DE POSE 10x60



Wall Coverings Silver Wood Classico, Silk Wood Classico, Ocean Wood Classico





Amsterdam

—
White
Beige
Grey



Amsterdam White



Description	Format	Codes	Group	Pcs	m2	Kg
Amsterdam White	40x80x1,4cm	100222691	G-270	1 x Cj	0,32 x Cj	12,00 x Cj
	15 3/4"x31 1/2"x1/2"	L108048381		78 x Pal	24,96 x Pal	936,00 x Pal
Amsterdam White	55/40/20x9,7x1,4cm	100213820	G-272	1 x Cj	0,67 x Cj	18,53 x Cj
	21 5/8"-15 3/4"-9 7/8"x3 7/8"x1/2"	L108047521		40 x Pal	26,77 x Pal	741,16 x Pal

Butech: Colorstuk Rapid Blanco



40x80x1,4cm

Each box contains a single 40x80x1,4cm piece. These pieces have two different textures. / Cada caja contiene una pieza de 40x80x1,4cm. Estas piezas presentan dos texturas diferentes. / Chaque boîte contient une pièce de 40x80x1,4cm. Ces pièces présentent deux textures différentes.

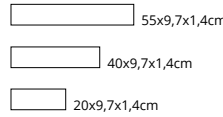

Each box contains 6 No. pieces 55x9,7x1,4cm, 6 No. pieces 40x9,7x1,4cm and 6 No. pieces 20x9,7x1,4cm. All formats have two different textures. / Cada caja contiene 6 piezas de 55x9,7x1,4cm, 6 piezas de 40x9,7x1,4cm y 6 piezas de 20x9,7x1,4cm. Todos los formatos presentan dos texturas diferentes. / Chaque boîte contient 6 pièces de 55x10x1,4cm, 6 pièces de 40x9,7x1,4cm et 6 pièces de 20x9,7x1,4cm. Tous les formats présentent deux textures différentes.



Amsterdam 3D Hexagon White



Description	Format	Codes	Group	Pcs	m2	Kg
Amsterdam 3D Hexagon White	19x19x1-1,4cm	100213788	G-281	24 x Cj	0,75 x Cj	21,50 x Cj
	7 1/2"x7 1/2"x3/8"-1/2"	L108047531		792 x Pal	24,79 x Pal	709,63 x Pal



No supported grouting
No admite rejuntado
Ne peut pas être jointoyé

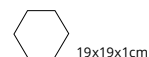

19x19x1cm

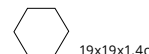

19x19x1,4cm

Each box contains 16 No. pieces 19x19x1cm and 8 No. pieces 19x19x1,4cm. Both formats have two different textures. / Cada caja contiene 16 piezas de 19x19x1cm y 8 piezas de 19x19x1,4cm. Ambos formatos presentan dos texturas diferentes. / Chaque boîte contient 16 pièces de 19x19x1cm et 8 pièces de 19x19x1,4cm. Les deux formats présentent deux textures différentes.

*Minimum order one box. Only full boxes.
Venta mínima una caja. Sólo cajas completas.
Unité de vente minimum par boîte. Uniquement boîtes complètes.

Marble / Mármol / Marbre



Amsterdam Hexagon White

-  BIOPROT
-  MATT
-  STRONG COLOR VARIATION
-  ORIGIN EUROPE
-  INDOOR FLOORING
-  INDOOR WALL COVERING
-  OUTDOOR FLOORING
-  OUTDOOR WALL COVERING
-  SHOWER WALL COVERINGS
-  SHOWER FLOORING
-  RAMP CLASSIFICATION

Description	Format	Codes	Group	Pcs	m2	Kg	
Amsterdam Hexagon White	19x19x1,4cm 7 1/2"x7 1/2"x1/2"	100213789 L108047671	G-281	19 x Cj 627 x Pal	0,59 x Cj 19,62 x Pal	24,32 x Cj 802,56 x Pal	Butech: Colorstuk Rapid Blanco

NEW

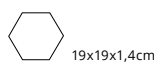

Each box contains 19 No. pieces 19x19x1,4cm. These pieces have two different textures. / Cada caja contiene 19 piezas de 19x19x1,4cm. Estas piezas presentan dos texturas diferentes. / Chaque boîte contient 19 pièces de 19x19x1,4cm. Ces pièces présentent deux textures différentes.



Wall Coverings Amsterdam Hexagon White

01

Amsterdam



Amsterdam Beige



Description	Format	Codes	Group	Pcs	m2	Kg
Amsterdam Beige	40x80x1,4cm	100173170	G-270	1 x Cj	0,32 x Cj	12,00 x Cj
	15 3/4"x31 1/2"x1/2"	L105003021		78 x Pal	24,96 x Pal	936,00 x Pal
Amsterdam Beige	55/40/20x9,7x1,4cm	100179882	G-272	1 x Cj	0,45 x Cj	17,32 x Cj
	21 5/8"-15 3/4"-9 7/8"x3 7/8"x1/2"	L105003511		40 x Pal	17,84 x Pal	692,76 x Pal

Butech: Colorstuk Rapid Beige



40x80x1,4cm

Each box contains a single 40x80x1,4cm piece. These pieces have two different textures. / Cada caja contiene una pieza de 40x80x1,4cm. Estas piezas presentan dos texturas diferentes. / Chaque boîte contient une pièce de 40x80x1,4cm. Ces pièces présentent deux textures différentes.

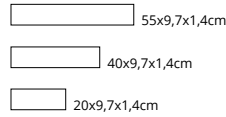

Each box contains 6 No. pieces 55x9,7x1,4cm, 6 No. pieces 40x9,7x1,4cm and 6 No. pieces 20x9,7x1,4cm. All formats have two different textures. / Cada caja contiene 6 piezas de 55x9,7x1,4cm, 6 piezas de 40x9,7x1,4cm y 6 piezas de 20x9,7x1,4cm. Todos los formatos presentan dos texturas diferentes. / Chaque boîte contient 6 pièces de 55x10x1,4cm, 6 pièces de 40x9,7x1,4cm et 6 pièces de 20x9,7x1,4cm. Tous les formats présentent deux textures différentes.



Amsterdam 3D Hexagon Beige



Description	Format	Codes	Group	Pcs	m2	Kg
Amsterdam 3D Hexagon Beige	19x19x1-1,4cm	100183944	G-281	24 x Cj	0,75 x Cj	21,50 x Cj
	7 1/2"x7 1/2"x3/8"-1/2"	L108040321		792 x Pal	24,79 x Pal	709,63 x Pal

No supported grouting
No admite rejuntado
Ne peut pas être jointoyé.

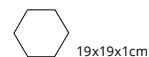

19x19x1cm

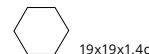

19x19x1,4cm

Each box contains 16 No. pieces 19x19x1cm and 8 No. pieces 19x19x1,4cm. Both formats have two different textures. / Cada caja contiene 16 piezas de 19x19x1cm y 8 piezas de 19x19x1,4cm. Ambos formatos presentan dos texturas diferentes. / Chaque boîte contient 16 pièces de 19x19x1cm et 8 pièces de 19x19x1,4cm. Les deux formats présentent deux textures différentes.

*Minimum order one box. Only full boxes.
Venta mínima una caja. Sólo cajas completas.
Unité de vente minimum par boîte. Uniquement boîtes complètes.

Limestone / Caliza / Pierre Calcaire



Amsterdam Hexagon Beige



Description	Format	Codes	Group	Pcs	m2	Kg
Amsterdam Hexagon Beige	19x19x1,4cm 7 1/2"x7 1/2"x1/2"	100179857 L105003781	G-281	19 x Cj 627 x Pal	0,59 x Cj 19,62 x Pal	19 x Cj 627 x Pal

Butech: Colorstuk Rapid Beige

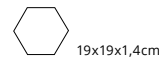

Each box contains 19 No. pieces 19x19x1,4cm. These pieces have two different textures. / Cada caja contiene 19 piezas de 19x19x1,4cm. Estas piezas presentan dos texturas diferentes. / Chaque boîte contient 19 pièces de 19x19x1,4cm. Ces pièces présentent deux textures différentes.



Floor Coverings Amsterdam Beige



Amsterdam Grey



Description	Format	Codes	Group	Pcs	m2	Kg
Amsterdam Grey	40x80x1,4cm 15 3/4"x31 1/2"x1/2"	100173151 L105003031	G-270	1 x Cj 78 x Pal	0,32 x Cj 24,96 x Pal	12,00 x Cj 936,00 x Pal
Amsterdam Grey	55/40/20x9,7x1,4cm 21 5/8"-15 3/4"-9 7/8"x3 7/8"x1/2"	100179863 L105003531	G-272	1 x Cj 40 x Pal	0,44 x Cj 17,85 x Pal	17,32 x Cj 692,76 x Pal

Butech: Colorstuk Rapid Gris



40x80x1,4cm

Each box contains a single 40x80x1,4cm piece. These pieces have two different textures. / Cada caja contiene una pieza de 40x80x1,4cm. Estas piezas presentan dos texturas diferentes. / Chaque boîte contient une pièce de 40x80x1,4cm. Ces pièces présentent deux textures différentes.

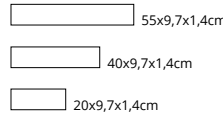

55x9,7x1,4cm

40x9,7x1,4cm

20x9,7x1,4cm

Each box contains 6 No. pieces 55x9,7x1,4cm, 6 No. pieces 40x9,7x1,4cm and 6 No. pieces 20x9,7x1,4cm. All formats have two different textures. / Cada caja contiene 6 piezas de 55x9,7x1,4cm, 6 piezas de 40x9,7x1,4cm y 6 piezas de 20x9,7x1,4cm. Todos los formatos presentan dos texturas diferentes. / Chaque boîte contient 6 pièces de 55x10x1,4cm, 6 pièces de 40x9,7x1,4cm et 6 pièces de 20x9,7x1,4cm. Tous les formats présentent deux textures différentes.



Amsterdam 3D Hexagon Grey



Description	Format	Codes	Group	Pcs	m2	Kg
Amsterdam 3D Hexagon Grey	19x19x1-1,4cm 7 1/2"x7 1/2"x3/8"-1/2"	100183929 L108040311	G-281	24 x Cj 792 x Pal	0,75 x Cj 24,79 x Pal	21,50 x Cj 709,63 x Pal

No supported grouting
No admite rejuntado
Ne peut pas être jointoyé.

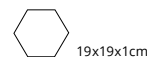

19x19x1cm

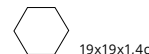

19x19x1,4cm

Each box contains 16 No. pieces 19x19x1cm and 8 No. pieces 19x19x1,4cm. Both formats have two different textures. / Cada caja contiene 16 piezas de 19x19x1cm y 8 piezas de 19x19x1,4cm. Ambos formatos presentan dos texturas diferentes. / Chaque boîte contient 16 pièces de 19x19x1cm et 8 pièces de 19x19x1,4cm. Les deux formats présentent deux textures différentes.

*Minimum order one box. Only full boxes.
Venta mínima una caja. Sólo cajas completas.
Unité de vente minimum par boîte. Uniquement boîtes complètes.

Limestone / Caliza / Pierre Calcaire



Amsterdam Hexagon Grey



Description	Format	Codes	Group	Pcs	m2	Kg
Amsterdam Hexagon Grey	19x19x1,4cm 7 1/2"x7 1/2"x1/2"	100179858 L105003771	G-281	19 x Cj 627 x Pal	0,59 x Cj 19,62 x Pal	19 x Cj 627 x Pal

Butech: Colorstuk Rapid Gris

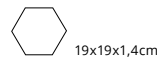

Each box contains 19 No. pieces 19x19x1,4cm. These pieces have two different textures. / Cada caja contiene 19 piezas de 19x19x1,4cm. Estas piezas presentan dos texturas diferentes. / Chaque boîte contient 19 pièces de 19x19x1,4cm. Ces pièces présentent deux textures différentes.



Floor Coverings Amsterdam Hexagon Grey / Floor Coverings Persian White Classico / Complementary Products W-Tower Roble Cloudy

01

Amsterdam



Amsterdam Grey Sand



Description	Format	Codes	Group	Pcs	m2	Kg
Amsterdam Grey Sand	40x80x1,5cm	100203110	G-279	1 x Cj	0,32 x Cj	13,08 x Cj
	15 3/4"x31 1/2"x3/4"	L105005031		78 x Pal	24,96 x Pal	1020,63 x Pal
Amsterdam Grey Sand	80x80x2cm	100203101	G-280	1 x Cj	0,64 x Cj	39,89 x Cj
	31 1/2"x31 1/2"x3/4"	L105005021		39 x Pal	24,96 x Pal	1360,86 x Pal

NEW

Butech: Colorstuk Rapid Gris



Floor Coverings Amsterdam Grey Sand / Wall Coverings Universe Dusk / Complementary Products Karon Circle Countertop

Limestone / Caliza / Pierre Calcaire



Floor Coverings Amsterdam Grey Sand / **Wall Coverings** Effect Square Black /
Complementary Products Karon Oval Countertop Tower 90 Persian White - Nogal Intense, Tower Mirror Nogal Intense



Limestone Caliza Pierre Calcaire

—
Calgary
Montreal
Sahara
Cream Aged
Vancouver
Ottawa

01

Limestone / Caliza / Pierre Calcaire



Calgary Classico



Butech: Colorstuk Rapid Marfil

Description	Format	Codes	Group	Pcs	m2	Kg
Calgary Classico	30x60x1,2cm	100098313	G-242	4 x Cj	0,72 x Cj	23,18 x Cj
	11 3/4"x23 5/8"x1/2"	L112995511		176 x Pal	31,68 x Pal	1020,10 x Pal
Calgary Classico	40x80x1,5cm	100188256	G-249	1 x Cj	0,31 x Cj	12,15 x Cj
	15 3/4"x31 1/2"x5/8"	L105004281		78 x Pal	24,18 x Pal	948,01 x Cj
Calgary Classico	60x60x1,5cm	100098317	G-249	1 x Cj	0,36 x Cj	14,39 x Cj
	23 5/8"x23 5/8"x5/8"	L105000561		40 x Pal	14,40 x Pal	575,48 x Pal
Slab / Tabla / Tranche	2cm	100155518	G-257	-	-	-
	3/4"	L105002501		-	-	-
Slab / Tabla / Tranche	3cm	100155519	G-267	-	-	-
	1 1/8"	L105002471		-	-	-



Floor Coverings Legend 1L Light, Calgary Classico / Wall Coverings Calgary Classico, Linkfloor Wall Contract Clay

Limestone / Caliza / Pierre Calcaire



Montreal Classico



Description	Format	Codes	Group	Pcs	m2	Kg
Montreal Classico	30x60x1,5cm 11 3/4"x23 5/8"x5/8"	100161172 L108032721	G-257	3 x Cj 132 x Pal	0,54 x Cj 23,76 x Pal	22,69 x Cj 998,71 x Pal
Montreal Classico	40x80x1,5cm 15 3/4"x31 1/2"x5/8"	100161173 L105002651	G-265	1 x Cj 78 x Pal	0,32 x Cj 24,96 x Pal	13,45 x Cj 1049,10 x Pal
Montreal Classico	60x60x1,5cm 23 5/8"x23 5/8"x5/8"	100161088 L108032841	G-265	1 x Cj 40 x Pal	0,36 x Cj 14,40 x Pal	15,13 x Cj 605,24 x Pal
Slab / Tabla / Tranche	2cm 3/4"	100161085 L105002631	G-252	-	-	-
Slab / Tabla / Tranche	3cm 1 1/8"	100161086 L105002641	G-260	-	-	-

Butech: Colorstuk Rapid Beige



Floor Coverings Montreal Classico / Wall Coverings Montreal Classico, Wood Square Aged

01

Limestone / Caliza / Pierre Calcaire



Sahara Anticato



Description	Format	Codes	Group	Pcs	m2	Kg
Sahara Anticato	Multiformato	100107321	G-252	1 x Cj	0,72 x Cj	24,18 x Cj
	Multiformat	L105001821		23 x Pal	16,56 x Pal	556,16 x Pal

MULTIFORMAT / MULTIFORMATO / MULTIFORMAT

Packet is served. 0,72 m2 per pack. composed of 40,6x40,6x1,2 (2pzs.). 20x20x1,2 (2pzs.). 40,6x61,2x1,2 (1pzs.). 20x40,6x1,2 (1pzs.) / Se sirve por paquetes. 0,72 m² por paquete. compuesto por 40,6x40,6x1,2 (2pzs.). 20x20x1,2 (2pzs.). 40,6x61,2x1,2 (1pzs.). 20x40,6x1,2 (1pzs.) / Paquet est servi. 0,72 m² par paquet. composé de 40,6x40,6x1,2 (2pzs.). 20x20x1,2 (2pzs.). 40,6x61,2x1,2 (1pzs.). 20x40,6x1,2 (1pzs.)

Butech: Colorstuk Rapid Bahama

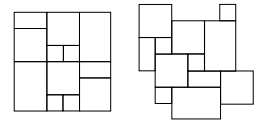

SUGGESTED LAYOUTS EJEMPLOS COLOCACIÓN EXEMPLES DE POSE



Floor Coverings Multiformato Sahara Anticato

Limestone / Caliza / Pierre Calcaire



Cream Aged Anticato



Description	Format	Codes	Group	Pcs	m2	Kg
Cream Aged Anticato	Multiformato Multiformat	100099768 L108016751	G-242	1 x Cj 38 x Pal	0,72 x Cj 27,36 x Pal	28,94 x Cj 1099,98 x Pal

MULTIFORMAT / MULTIFORMATO / MULTIFORMAT

Packet is served. 0,72 m2 per pack. composed of 40,6x40,6x1,2 (2pzs.). 20x20x1,2 (2pzs.). 40,6x61,2x1,2 (1pzs.). 20x40,6x1,2 (1pzs.) / Se sirve por paquetes. 0,72 m² por paquete. compuesto por 40,6x40,6x1,2 (2pzs.). 20x20x1,2 (2pzs.). 40,6x61,2x1,2 (1pzs.). 20x40,6x1,2 (1pzs.) / Paquet est servi. 0,72 m² par paquet. composé de 40,6x40,6x1,2 (2pzs.). 20x20x1,2 (2pzs.). 40,6x61,2x1,2 (1pzs.). 20x40,6x1,2 (1pzs.)

Butech: Colorstuk Rapid Gris

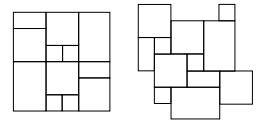

SUGGESTED LAYOUTS EJEMPLOS COLOCACIÓN EXEMPLES DE POSE



Floor Coverings Multiformato Cream Aged Anticato

01

Limestone / Caliza / Pierre Calcaire



Vancouver Classico



Description	Format	Codes	Group	Pcs	m2	Kg
Vancouver Classico	30x60x1,4cm	100146823	G-260	3 x Cj	0,54 x Cj	19,05 x Cj
	11 3/4"x23 5/8"x1/2"	L108026641		132 x Pal	23,76 x Pal	838,20 x Pal
Vancouver Classico	40x80x2cm	100146082	G-267	1 x Cj	0,32 x Cj	16,24 x Cj
	15 3/4"x31 1/2"x3/4"	L105002311		78 x Pal	24,96 x Pal	1267,11 x Pal
Slab / Tabla / Tranche	2cm	100155575	G-255	-	-	-
	3/4"	L105002491		-	-	-
Slab / Tabla / Tranche	3cm	100155576	G-267	-	-	-
	1 1/8"	L105002511		-	-	-

Butech: Colorstuk Rapid Gris



Floor Coverings Vancouver Classico / Wall Coverings Vancouver Classico, Armour Caramel

Limestone / Caliza / Pierre Calcaire



Ottawa Pulido



Description	Format	Codes	Group	Pcs	m2	Kg
Ottawa Pulido	30x60x1,5cm	100168288	G-257	3 x Cj	0,54 x Cj	23,39 x Cj
	11 3/4"x23 5/8"x5/8"	L112996301		132 x Pal	23,76 x Pal	1029,34 x Pal
Ottawa Pulido	40x80x1,5cm	100168314	G-265	1 x Cj	0,32 x Cj	13,86 x Cj
	15 3/4"x31 1/2"x5/8"	L105002751		78 x Pal	24,96 x Pal	1081,24 x Pal
Ottawa Pulido	60x60x2cm	100168330	G-267	1 x Cj	0,36 x Cj	20,80 x Cj
	23 5/8"x23 5/8"x3/4"	L105002971		40 x Pal	14,40 x Pal	831,80 x Pal
Slab / Tabla / Tranche	2cm	100176348	G-267	-	-	-
	3/4"	L105003161		-	-	-
Slab / Tabla / Tranche	3cm	100176337	G-279	-	-	-
	1 1/8"	L105003171		-	-	-

Butech: Colorstuk Rapid Beige



Floor Coverings Ottawa Pulido / Wall Coverings Amsterdam 3D Hexagon Beige



Quartzite Cuarcita Quartzite

—
Chennai White
Lagos Black
Sherpa Brown

01

Quartzite / Cuarcita / Quartzite



Chennai White Flamed Home



Description	Format	Codes	Group	Pcs	m2	Kg
Chennai White Flamed Home	30x60x1,5cm	100162737	G-240	3 x Cj	0,54 x Cj	24,18 x Cj
	11 3/4"x23 5/8"x5/8"	L107601281		132 x Pal	23,76 x Pal	1063,92 x Pal
Chennai White Flamed Home	40x80x1,5cm	100086252	G-246	1 x Cj	0,32 x Cj	14,33 x Cj
	15 3/4"x31 1/2"x5/8"	L107000151		78 x Pal	24,96 x Pal	1117,82 x Pal
Chennai White Flamed Home	60x60x1,5cm	100220345	G-246	1 x Cj	0,36 x Cj	16,12 x Cj
	23 5/8"x23 5/8"x5/8"	L225951811		40 x Pal	14,40 x Pal	644,84 x Pal

Butech: Colorstuk Rapid Gris



Wall Coverings Chennai White Flamed Home / Complementary Products Geisha Crema Italia Classico, Khoa Crema Italia Classico

Quartzite / Cuarcita / Quartzite



Lagos Black Home



Description	Format	Codes	Group	Pcs	m2	Kg
Lagos Black Home	30x60x1,5cm 11 3/4"x23 5/8"x5/8"	100120894 L107600251	G-246	3 x Cj 132 x Pal	0,54 x Cj 23,76 x Pal	41,74 x Cj 1836,78 x Pal
Lagos Black Home	40x80x1,5cm 15 3/4"x31 1/2"x5/8"	100120895 L107600241	G-249	1 x Cj 78 x Pal	0,32 x Cj 24,96 x Pal	13,91 x Cj 1085,37 x Pal

Butech: Colorstuk Rapid Negro



Wall Coverings Lagos Black Home

01

Quartzite / Cuarcita / Quartzite



Sherpa Brown Home



Description	Format	Codes	Group	Pcs	m2	Kg
Sherpa Brown Home	30x60x1,5cm	100081826	G-255	3 x Cj	0,54 x Cj	23,51 x Cj
	11 3/4"x23 5/8"x5/8"	L112995131		132 x Pal	23,76 x Pal	1034,48 x Pal
Sherpa Brown Home	40x80x1,5cm	100073338	G-260	1 x Cj	0,32 x Cj	13,93 x Cj
	15 3/4"x31 1/2"x5/8"	L106200121		78 x Pal	24,96 x Pal	1086,85 x Pal
Sherpa Brown Home	60x60x1,5cm	100098379	G-260	1 x Cj	0,36 x Cj	15,53 x Cj
	23 5/8"x23 5/8"x5/8"	L107000571		40 x Pal	14,40 x Pal	621 x Pal
Slab / Tabla / Tranche	2cm 3/4"	100155574 L107601051	G-265	-	-	-

Butech: Colorstuk Rapid Antracita



Wall Coverings Sherpa Brown Home

Quartzite / Cuarcita / Quartzite



Sandstone Arenisca Grès

—
Desert Sandstone
Blue Sandstone



01

Sandstone / Arenisca / Grès



Desert Sandstone Classico



Butech: Colorstuk Rapid Gris

Description	Format	Codes	Group	Pcs	m2	Kg
Desert Sandstone Classico	40x80x2cm	100120889	G-255	1 x Cj	0,32 x Cj	15,87 x Cj
	15 3/4"x31 1/2"x3/4"	L107500471		78 x Pal	24,96 x Pal	1238 x Pal
Slab / Tabla / Tranche	2cm	100155570	G-232	-	-	-
	3/4"	L107500531		-	-	-
Slab / Tabla / Tranche	3cm	100155571	G-238	-	-	-
	1 1/8"	L107500541		-	-	-



Floor Coverings Desert Sandstone Classico / **Wall Coverings** Desert Sandstone Classico, Elite Brick Creams **Complementary Products** W-Tower Nogal Intense

Sandstone / Arenisca / Grès



Blue Sandstone Classico



Butech: Colorstuk Rapid Gris

Description	Format	Codes	Group	Pcs	m2	Kg
Blue Sandstone Classico	30x60x1,5cm	100168307	G-257	3 x Cj	0,54 x Cj	21,60 x Cj
	11 3/4"x23 5/8"x5/8"	L112995831		132 x Pal	23,76 x Pal	950,40 x Pal
Blue Sandstone Classico	40x80x1,5cm	100168321	G-263	1 x Cj	0,32 x Cj	12 x Cj
	15 3/4"x31 1/2"x5/8"	L108035341		78 x Pal	24,96 x Pal	936 x Pal
Slab / Tabla / Tranche	2cm	100179380	G-255	-	-	-
	3/4"	L107501071		-	-	-
Slab / Tabla / Tranche	3cm	100179355	G-268	-	-	-
	1 1/8"	L107501061		-	-	-



Floor Coverings Blue Sandstone / Wall Coverings Wood Wall Bronze

Slate Pizarra Ardoise

—
Bhutan
Patagonia
Nepal
Bombay
Delhi
Fidji
Kathmandu





Bhutan Natural

-  BIOPROT
-  IRREGULAR TEXTURE
-  MATT
-  SLIGHT COLOR VARIATION
-  ORIGIN EUROPE
-  INDOOR FLOORING
-  INDOOR WALL COVERING
-  OUTDOOR FLOORING
-  OUTDOOR WALL COVERING
-  SHOWER WALL COVERINGS
-  COUNTERTOPS
-  POOL SURROUNDINGS
-  RAMP CLASSIFICATION

Description	Format	Codes	Group	Pcs	m2	Kg
Bhutan Natural	30x60x1,2cm	100069634	G-242	4 x Cj	0,72 x Cj	23,76 x Cj
	11 3/4"x23 5/8"x1/2"	L112995111		176 x Pal	31,68 x Pal	1045,44 x Pal
Bhutan Natural	40x80x2cm	100081435	G-270	1 x Cj	0,32 x Cj	19,23 x Cj
	15 3/4"x31 1/2"x3/4"	L106200181		78 x Pal	24,96 x Pal	1499,94 x Pal

Butech: Colorstuk Rapid Antracita



Floor Coverings Desert Sandstone Classico / Wall Coverings Bhutan Natural

Slate / Pizarra / Ardoise



Patagonia Home



Butech: Colorstuk Rapid Antracita

Description	Format	Codes	Group	Pcs	m2	Kg
Patagonia Home	30x60x1cm 11 3/4"x23 5/8"x3/8"	100000176 L112952031	G-238	4 x Cj 176 x Pal	0,72 x Cj 31,66 x Pal	26,28 x Cj 1156,32 x Pal
Patagonia Home	60x60x1cm 23 5/8"x23 5/8"x3/8"	100007870 L116648011	G-244	2 x Cj 92 x Pal	0,72 x Cj 33,12 x Pal	20,95 x Cj 963,61 x Pal
Patagonia Home	160x60x2cm 63"x23 5/8"x3/4"	100001538 L150301031	G-263	1 x Cj 21 x Pal	0,96 x Cj 20,19 x Pal	56,30 x Cj 1182,30 x Pal



Floor Coverings Patagonia Home / Wall Coverings Patagonia Home, Globe Stick Nepal



Nepal Natural

- BIOPROT
- IRREGULAR TEXTURE
- MATT
- STRONG COLOR VARIATION
- ORIGIN ASIA
- INDOOR FLOORING
- INDOOR WALL COVERING
- OUTDOOR FLOORING
- OUTDOOR WALL COVERING
- SHOWER WALL COVERINGS
- COUNTERTOPS
- POOL SURROUNDINGS
- RAMP CLASSIFICATION

Description	Format	Codes	Group	Pcs	m2	Kg
Nepal Natural	30x60x1,2-1,4cm	100069167	G-238	3 x Cj	0,54 x Cj	19,07 x Cj
	11 3/4"x23 5/8"x1/2"	L112995101		132 x Pal	23,76 x Pal	839 x Pal
Nepal Natural	60x90x1,4-1,8cm	100081419	G-255	1 x Cj	0,54 x Cj	23,14 x Cj
	23 5/8"x35 3/8"x1/2"-3/4"	L151501511		46 x Pal	24,84 x Pal	1064,71 x Pal

STOCK

Butech: Colorstuk Rapid Cemento



Wall Coverings Nepal Natural

Slate / Pizarra / Ardoise



Bombay Natural Home



Description	Format	Codes	Group	Pcs	m2	Kg
Bombay Natural Home	30x60x1,2cm	100065522	G-240	3 x Cj	0,54 x Cj	20,25 x Cj
	11 3/4"x23 5/8"x1/2"	L108005901		132 x Pal	23,76 x Pal	891 x Pal
Bombay Natural Home	40x80x1,5cm	100078649	G-252	1 x Cj	0,32 x Cj	14,10 x Cj
	15 3/4"x31 1/2"x5/8"	L106200141		78 x Pal	24,96 x Pal	1100 x Pal

Butech: Colorstuk Rapid Caramelo



Bombay Pulido



Description	Format	Codes	Group	Pcs	m2	Kg
Bombay Pulido	30x60x1,2cm	100065786	G-242	4 x Cj	0,72 x Cj	26,81 x Cj
	11 3/4"x23 5/8"x1/2"	L106400011		176 x Pal	31,68 x Pal	1179,55 x Pal
Bombay Pulido	40x80x1,5cm	100080210	G-255	1 x Cj	0,32 x Cj	13,46 x Cj
	15 3/4"x31 1/2"x5/8"	L106200151		78 x Pal	24,96 x Pal	1050 x Pal

Butech: Colorstuk Rapid Caramelo

01

Slate / Pizarra / Ardoise



Delhi Natural Home



Description	Format	Codes	Group	Pcs	m2	Kg
Delhi Natural Home	30x60x1,2cm	100065523	G-232	3 x Cj	0,54 x Cj	20,25 x Cj
	11 3/4"x23 5/8"x1/2"	L108005911		132 x Pal	23,76 x Pal	891 x Pal
Delhi Natural Home	40x80x1,5cm	100078650	G-242	1 x Cj	0,32 x Cj	14,10 x Cj
	15 3/4"x31 1/2"x5/8"	L106200131		78 x Pal	24,96 x Pal	1100 x Pal

Butech: Colorstuk Rapid Cemento



Delhi Pulido



Description	Format	Codes	Group	Pcs	m2	Kg
Delhi Pulido	30x60x1,2cm	100082874	G-238	4 x Cj	0,72 x Cj	28,19 x Cj
	11 3/4"x23 5/8"x1/2"	L106400021		176 x Pal	31,68 x Pal	1240,45 x Pal
Delhi Pulido	40x80x1,5cm	100080212	G-244	1 x Cj	0,32 x Cj	14,10 x Cj
	15 3/4"x31 1/2"x5/8"	L106200161		78 x Pal	24,96 x Pal	1100 x Pal

Butech: Colorstuk Rapid Cemento

Slate / Pizarra / Ardoise



Fidji Natural Home

-  BIOPROT
-  IRREGULAR TEXTURE
-  MATT
-  STRONG COLOR VARIATION
-  ORIGIN ASIA
-  INDOOR FLOORING
-  INDOOR WALL COVERING
-  OUTDOOR FLOORING
-  OUTDOOR WALL COVERING
-  SHOWER WALL COVERINGS
-  COUNTERTOPS
-  POOL SURROUNDINGS
-  RAMP CLASSIFICATION

Description	Format	Codes	Group	Pcs	m2	Kg
Fidji Natural Home	40x80x1,5cm 15 3/4"x31 1/2"x5/8"	100099457 L107500421	G-255	1 x Cj 78 x Pal	0,32 x Cj 24,96 x Pal	14,10 x Cj 1100 x Pal

Butech: Colorstuk Rapid Cemento / Antracita



Floor Coverings Fidji Natural Home / Complementary Products Round Persian White Classico, Hampton Nogal Warm, Khoa Persian White



Kathmandu Natural Home



Description	Format	Codes	Group	Pcs	m2	Kg
Kathmandu Natural Home	30x60x1,2cm	100090983	G-244	3 x Cj	0,54 x Cj	21,78 x Cj
	11 3/4"x23 5/8"x1/2"	L107000321		132 x Pal	23,76 x Pal	958,45 x Pal
Kathmandu Natural Home	40x80x1,5cm	100086259	G-257	1 x Cj	0,32 x Cj	14,62 x Cj
	15 3/4"x31 1/2"x5/8"	L107000161		78 x Pal	24,96 x Pal	1140 x Pal

Butech: Colorstuk Rapid Manhattan

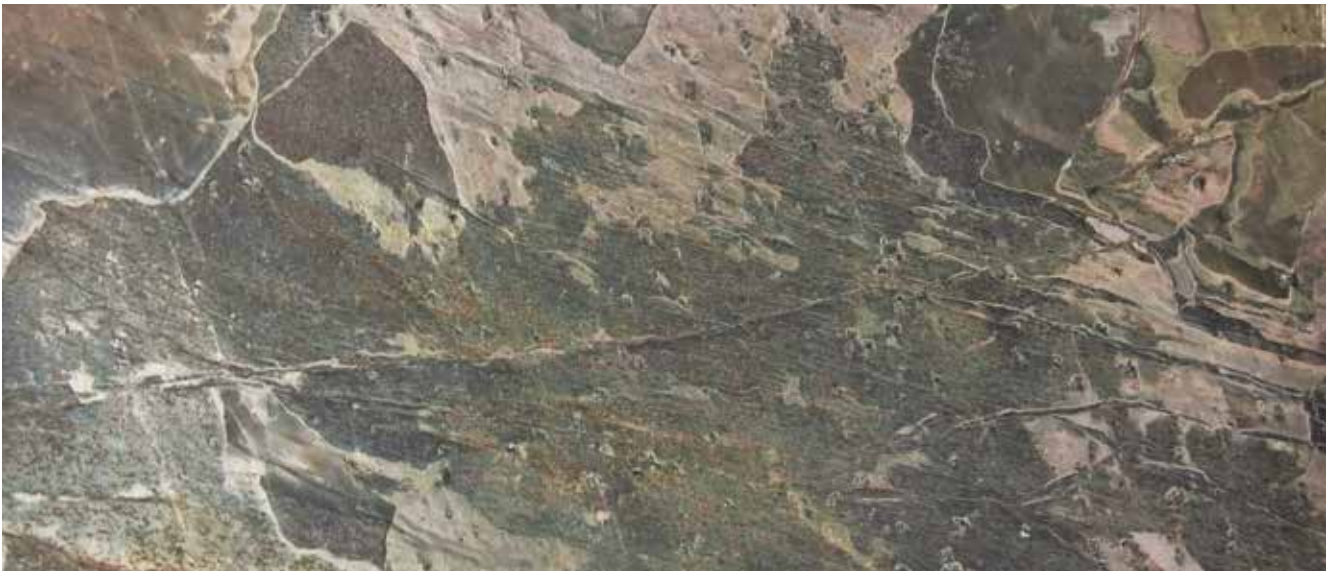

Kathmandu Pulido



Description	Format	Codes	Group	Pcs	m2	Kg
Kathmandu Pulido	30x60x1,2cm	100090984	G-242	4 x Cj	0,72 x Cj	24,70 x Cj
	11 3/4"x23 5/8"x1/2"	L107000331		176 x Pal	31,68 x Pal	1086,62 x Pal
Kathmandu Pulido	40x80x1,5cm	100086260	G-255	1 x Cj	0,32 x Cj	13,93 x Cj
	15 3/4"x31 1/2"x5/8"	L107000131		78 x Pal	24,96 x Pal	1086,70 x Pal

Butech: Colorstuk Rapid Manhattan





Airslate

—
Patna
Bombay
Delhi
Kathmandu
Forest
Metal
Kashmir
Graphite



Floor Coverings Paradise Tinybroken Edge Negro / Wall Coverings Airslate Graphite / Complementary Products Conjunto Karon Circle persian White-Nogal Intense, Tower Mirror Nogal Intense



Airslate Patna



Description	Format	Codes	Group	Pcs	m2	Kg
Airslate Patna	240x120x0,2-0,4cm	100201920	G-238	5 x Cj	14,40 x Cj	65 x Cj
	47 1/4"x94 1/2"x1/16"-3/16"	L108044651		110 x Pal	316,80 x Pal	1430 x Pal
Airslate Patna	120x60x0,2-0,4cm	100201887	G-234	15 x Cj	10,80 x Cj	41,52 x Cj
	23 5/8"x47 1/4"x1/16"-3/16"	L107001081		135 x Pal	97,20 x Pal	373,68 x Pal

NEW



Butech: Colorstuk Rapid Cemento

- C1. Slate / Pizarra / Ardoise
- C2. Adhesive / Adhesivo / Adhésif
- C3. Fiber Glass / Fibra de vidrio / Fibre de verre
- C4. Background / Base / Fond

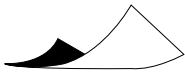

FLEXIBLE MATERIAL / MATERIAL FLEXIBLE / MATÉRIAU FLEXIBLE

Airslate is manufactured with a fiberglass layer which reinforces the structure, provides greater flexibility, and enables installation on curved areas with a radius of up to 35cm. / *Airslate está realizado con una capa de fibra de vidrio que refuerza su estructura y le otorga un amplio grado de flexión, lo que permite ser instalado en zonas curvadas con un radio de hasta 35cm. / Airslate est fabriqué avec une couche en fibre de verre qui en renforce la structure et lui confère une grande capa-cité de flexion, ce qui permet de l'installer dans des espaces courbes d'un rayon pouvant aller jusqu'à 35cm.*



Airslate Bombay



Description	Format	Codes	Group	Pcs	m2	Kg
Airslate Bombay	240x120x0,2-0,4cm	100161532	G-238	5 x Cj	14,40 x Cj	60 x Cj
	47 1/4"x94 1/2"x1/16"-3/16"	L106200891		110 x Pal	316,80 x Pal	1320 x Pal
Airslate Bombay	120x60x0,2-0,4cm	100179699	G-234	15 x Cj	10,80 x Cj	41,52 x Cj
	23 5/8"x47 1/4"x1/16"-3/16"	L107001001		135 x Pal	97,20 x Pal	373,68 x Pal

STOCK



Butech: Colorstuk Rapid Caramelo

- C1. Slate / Pizarra / Ardoise
- C2. Adhesive / Adhesivo / Adhésif
- C3. Fiber Glass / Fibra de vidrio / Fibre de verre
- C4. Background / Base / Fond



FLEXIBLE MATERIAL / MATERIAL FLEXIBLE / MATÉRIAU FLEXIBLE

Airslate is manufactured with a fiberglass layer which reinforces the structure, provides greater flexibility, and enables installation on curved areas with a radius of up to 35cm. / *Airslate está realizado con una capa de fibra de vidrio que refuerza su estructura y le otorga un amplio grado de flexión, lo que permite ser instalado en zonas curvadas con un radio de hasta 35cm. / Airslate est fabriqué avec une couche en fibre de verre qui en renforce la structure et lui confère une grande capa-cité de flexion, ce qui permet de l'installer dans des espaces courbes d'un rayon pouvant aller jusqu'à 35cm.*

Airslate



Airslate Delhi



Description	Format	Codes	Group	Pcs	m2	Kg
Airslate Delhi	240x120x0,2-0,4cm	100161533	G-238	5 x Cj	14,40 x Cj	60 x Cj
	47 1/4"x94 1/2"x1/16"-3/16"	L106200931		110 x Pal	316,80 x Pal	1320 x Pal
Airslate Delhi	120x60x0,2-0,4cm	100179714	G-234	15 x Cj	10,80 x Cj	41,52 x Cj
	23 5/8"x47 1/4"x1/16"-3/16"	L107001021		135 x Pal	97,2 x Pal	373,68 x Pal

Butech: Colorstuk Rapid Cemento

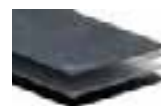

- C1. Slate / Pizarra / Ardoise
- C2. Adhesive / Adhesivo / Adhésif
- C3. Fiber Glass / Fibra de vidrio / Fibre de verre
- C4. Background / Base / Fond



FLEXIBLE MATERIAL / MATERIAL FLEXIBLE / MATÉRIAU FLEXIBLE

Airslate is manufactured with a fiberglass layer which reinforces the structure, provides greater flexibility, and enables installation on curved areas with a radius of up to 35cm. / *Airslate está realizado con una capa de fibra de vidrio que refuerza su estructura y le otorga un amplio grado de flexión, lo que permite ser instalado en zonas curvadas con un radio de hasta 35cm. / Airslate est fabriqué avec une couche en fibre de verre qui en renforce la structure et lui confère une grande capa-cité de flexion, ce qui permet de l'installer dans des espaces courbes d'un rayon pouvant aller jusqu'à 35cm.*



Airslate Kathmandu



Description	Format	Codes	Group	Pcs	m2	Kg
Airslate Kathmandu	240x120x0,2-0,4cm	100161516	G-238	5 x Cj	14,40 x Cj	60 x Cj
	47 1/4"x94 1/2"x1/16"-3/16"	L106200911		110 x Pal	316,80 x Pal	1320 x Pal
Airslate Kathmandu	120x60x0,2-0,4cm	100179715	G-234	15 x Cj	10,80 x Cj	41,52 x Cj
	23 5/8"x47 1/4"x1/16"-3/16"	L107001011		135 x Pal	97,2 x Pal	373,68 x Pal

Butech: Colorstuk Rapid Manhattan



- C1. Slate / Pizarra / Ardoise
- C2. Adhesive / Adhesivo / Adhésif
- C3. Fiber Glass / Fibra de vidrio / Fibre de verre
- C4. Background / Base / Fond



FLEXIBLE MATERIAL / MATERIAL FLEXIBLE / MATÉRIAU FLEXIBLE

Airslate is manufactured with a fiberglass layer which reinforces the structure, provides greater flexibility, and enables installation on curved areas with a radius of up to 35cm. / *Airslate está realizado con una capa de fibra de vidrio que refuerza su estructura y le otorga un amplio grado de flexión, lo que permite ser instalado en zonas curvadas con un radio de hasta 35cm. / Airslate est fabriqué avec une couche en fibre de verre qui en renforce la structure et lui confère une grande capa-cité de flexion, ce qui permet de l'installer dans des espaces courbes d'un rayon pouvant aller jusqu'à 35cm.*



Airslate Forest



Description	Format	Codes	Group	Pcs	m2	Kg
Airslate Forest	240x120x0,2-0,4cm 47 1/4"x94 1/2"x1/16"-3/16"	100161514 L106200901	G-238	5 x Cj 110 x Pal	14,40 x Cj 316,80 x Pal	60 x Cj 1320 x Pal
Airslate Forest	120x60x0,2-0,4cm 23 5/8"x47 1/4"x1/16"-3/16"	100179721 L107001031	G-234	15 x Cj 135 x Pal	10,80 x Cj 97,2 x Pal	41,52 x Cj 373,68 x Pal

Butech: Colorstuk Rapid Manhattan



- C1. Slate / Pizarra / Ardoise
- C2. Adhesive / Adhesivo / Adhésif
- C3. Fiber Glass / Fibra de vidrio / Fibre de verre
- C4. Background / Base / Fond

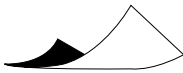

FLEXIBLE MATERIAL / MATERIAL FLEXIBLE / MATÉRIAU FLEXIBLE

Airslate is manufactured with a fiberglass layer which reinforces the structure, provides greater flexibility, and enables installation on curved areas with a radius of up to 35cm. / *Airslate está realizado con una capa de fibra de vidrio que refuerza su estructura y le otorga un amplio grado de flexión, lo que permite ser instalado en zonas curvas con un radio de hasta 35cm. / Airslate est fabriqué avec une couche en fibre de verre qui en renforce la structure et lui confère une grande capacité de flexion, ce qui permet de l'installer dans des espaces courbes d'un rayon pouvant aller jusqu'à 35cm.*



Airslate Metal



Description	Format	Codes	Group	Pcs	m2	Kg
Airslate Metal	240x120x0,2-0,4cm 47 1/4"x94 1/2"x1/16"-3/16"	100161526 L106200921	G-238	5 x Cj 110 x Pal	14,40 x Cj 316,80 x Pal	60 x Cj 1320 x Pal
Airslate Metal	120x60x0,2-0,4cm 23 5/8"x47 1/4"x1/16"-3/16"	100179732 L107001061	G-234	15 x Cj 135 x Pal	10,80 x Cj 97,2 x Pal	41,52 x Cj 373,68 x Pal

Butech: Colorstuk Rapid Cemento

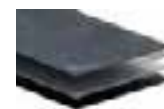

- C1. Slate / Pizarra / Ardoise
- C2. Adhesive / Adhesivo / Adhésif
- C3. Fiber Glass / Fibra de vidrio / Fibre de verre
- C4. Background / Base / Fond



FLEXIBLE MATERIAL / MATERIAL FLEXIBLE / MATÉRIAU FLEXIBLE

Airslate is manufactured with a fiberglass layer which reinforces the structure, provides greater flexibility, and enables installation on curved areas with a radius of up to 35cm. / *Airslate está realizado con una capa de fibra de vidrio que refuerza su estructura y le otorga un amplio grado de flexión, lo que permite ser instalado en zonas curvas con un radio de hasta 35cm. / Airslate est fabriqué avec une couche en fibre de verre qui en renforce la structure et lui confère une grande capacité de flexion, ce qui permet de l'installer dans des espaces courbes d'un rayon pouvant aller jusqu'à 35cm.*

Airslate



Airslate Kashmir



Description	Format	Codes	Group	Pcs	m2	Kg
Airslate Kashmir	240x120x0,2-0,4cm	100161506	G-238	5 x Cj	14,40 x Cj	60 x Cj
	47 1/4"x94 1/2"x1/16"-3/16"	L106200871		110 x Pal	316,80 x Pal	1320 x Pal
Airslate Kashmir	120x60x0,2-0,4cm	100179705	G-234	15 x Cj	10,80 x Cj	41,52 x Cj
	23 5/8"x47 1/4"x1/16"-3/16"	L107001041		135 x Pal	97,2 x Pal	373,68 x Pal

STOCK

Butech: Colorstuk Rapid Cemento



- C1. Slate / Pizarra / Ardoise
- C2. Adhesive / Adhesivo / Adhésif
- C3. Fiber Glass / Fibra de vidrio / Fibre de verre
- C4. Background / Base / Fond

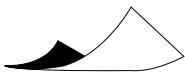

FLEXIBLE MATERIAL / MATERIAL FLEXIBLE / MATÉRIAU FLEXIBLE

Airslate is manufactured with a fiberglass layer which reinforces the structure, provides greater flexibility, and enables installation on curved areas with a radius of up to 35cm. / *Airslate está realizado con una capa de fibra de vidrio que refuerza su estructura y le otorga un amplio grado de flexión, lo que permite ser instalado en zonas curvadas con un radio de hasta 35cm. / Airslate est fabriqué avec une couche en fibre de verre qui en renforce la structure et lui confère une grande capa-cité de flexion, ce qui permet de l'installer dans des espaces courbes d'un rayon pouvant aller jusqu'à 35cm.*



Airslate Graphite



Description	Format	Codes	Group	Pcs	m2	Kg
Airslate Graphite	240x120x0,2-0,4cm	100161515	G-238	5 x Cj	14,40 x Cj	60 x Cj
	47 1/4"x94 1/2"x1/16"-3/16"	L106200941		110 x Pal	316,80 x Pal	1320 x Pal
Airslate Graphite	120x60x0,2-0,4cm	100179731	G-234	15 x Cj	10,80 x Cj	41,52 x Cj
	23 5/8"x47 1/4"x1/16"-3/16"	L107001051		135 x Pal	97,2 x Pal	373,68 x Pal

STOCK

Butech: Colorstuk Rapid Cemento



- C1. Slate / Pizarra / Ardoise
- C2. Adhesive / Adhesivo / Adhésif
- C3. Fiber Glass / Fibra de vidrio / Fibre de verre
- C4. Background / Base / Fond



FLEXIBLE MATERIAL / MATERIAL FLEXIBLE / MATÉRIAU FLEXIBLE

Airslate is manufactured with a fiberglass layer which reinforces the structure, provides greater flexibility, and enables installation on curved areas with a radius of up to 35cm. / *Airslate está realizado con una capa de fibra de vidrio que refuerza su estructura y le otorga un amplio grado de flexión, lo que permite ser instalado en zonas curvadas con un radio de hasta 35cm. / Airslate est fabriqué avec une couche en fibre de verre qui en renforce la structure et lui confère une grande capa-cité de flexion, ce qui permet de l'installer dans des espaces courbes d'un rayon pouvant aller jusqu'à 35cm.*

Globe

—
Brick
Stick
Castle
Wall





Globe Brick Nepal

10x40x1,5-2,5cm - 3 7/8"x15 3/4x3/4"-1"
100001583 - L153201501 - G-260



SLATE / PIZARRA / ARDOISE

No supported grouting / No admite rejuntado /
Ne peut pas être jointoyé.

Pcs	m2	Kg
10 x Cj 420 x Pal	0,40 x Cj 16,80 x Pal	26,19 x Cj 1099,98 x Pal



Globe Brick Indira

10x40x2-2,5cm - 3 7/8"x15 3/4x3/4"-1"
100044752 - L153201581 - G-255



QUARTZITE / CUARCITA / QUARTZITE

No supported grouting / No admite rejuntado /
Ne peut pas être jointoyé.

Pcs	m2	Kg
10 x Cj 420 x Pal	0,38 x Cj 15,96 x Pal	19,77 x Cj 830,34 x Pal



Globe Brick Delhi

10x40x2-2,5cm - 3 7/8"x15 3/4x3/4"-1"
100200281 - L108043481 - G-249



SLATE / PIZARRA / ARDOISE

No supported grouting / No admite rejuntado /
Ne peut pas être jointoyé.

Pcs	m2	Kg
10 x Cj 420 x Pal	0,38 x Cj 15,96 x Pal	19,77 x Cj 830,34 x Pal



Globe Corner Brick Nepal

10x38x2-2,5cm - 3 7/8"x15x3/4"-1"
100032187 - L153201571 - G-263



SLATE / PIZARRA / ARDOISE

No supported grouting / No admite rejuntado /
Ne peut pas être jointoyé.

Pcs	m2	Kg
10 x Cj 420 x Pal	0,38 x Cj 15,96 x Pal	19,77 x Cj 830,34 x Pal



Globe Corner Brick Indira

10x38x2-2,5cm - 3 7/8"x15x3/4"-1"
100044753 - L153201591 - G-257



QUARTZITE / CUARCITA / QUARTZITE

No supported grouting / No admite rejuntado /
Ne peut pas être jointoyé.

Pcs	m2	Kg
12 x Cj 504 x Pal	0,45 x Cj 19,15 x Pal	15,15 x Cj 636,55 x Pal



Globe Brick Delhi

10x38x2-2,5cm - 3 7/8"x15x3/4"-1"
100060208 - L153201641 - G-252



SLATE / PIZARRA / ARDOISE

No supported grouting / No admite rejuntado /
Ne peut pas être jointoyé.

Pcs	m2	Kg
10 x Cj 420 x Pal	0,38 x Cj 15,96 x Pal	24,43 x Cj 1026,06 x Pal

Globe



Globe Brick Blanco Almeria

10x40x2-2,5cm - 3 7/8"x15 3/4x3/4"-1"
100031998 - L153201541 - G-282



MARBLE / MARMOL / MARBRE

No supported grouting / No admite rejuntado /
Ne peut pas être jointoyé.

Pcs	m2	Kg
10 x Cj 420 x Pal	0,40 x Cj 16,80 x Pal	17,85 x Cj 749,70 x Pal



Globe Brick Bhutan

10x40x2-2,5cm - 3 7/8"x15 3/4x3/4"-1"
100001585 - L153201521 - G-249



SLATE / PIZARRA / ARDOISE

No supported grouting / No admite rejuntado /
Ne peut pas être jointoyé.

Pcs	m2	Kg
12 x Cj 504 x Pal	0,48 x Cj 20,16 x Pal	21,37 x Cj 897,62 x Pal



Globe Brick Bombay

10x40x2-2,5cm - 3 7/8"x15 3/4x3/4"-1"
100200280 - L108043491 - G-249



SLATE / PIZARRA / ARDOISE

No supported grouting / No admite rejuntado /
Ne peut pas être jointoyé.

Pcs	m2	Kg
10 x Cj 360 x Pal	0,40 x Cj 14,40 x Pal	15,83 x Cj 569,88 x Pal



Globe Corner Blanco Almeria

10x38x2-2,5cm - 3 7/8"x15x3/4"-1"
100032128 - L153201531 - G-283



MARBLE / MARMOL / MARBRE

No supported grouting / No admite rejuntado /
Ne peut pas être jointoyé.

Pcs	m2	Kg
10 x Cj 420 x Pal	0,38 x Cj 15,96 x Pal	17,18 x Cj 721,56 x Pal



Globe Corner Brick Bhutan

10x38x2-2,5cm - 3 7/8"x15x3/4"-1"
100032184 - L153201551 - G-252



SLATE / PIZARRA / ARDOISE

No supported grouting / No admite rejuntado /
Ne peut pas être jointoyé.

Pcs	m2	Kg
12 x Cj 504 x Pal	0,45 x Cj 19,15 x Pal	18,02 x Cj 757,01 x Pal



Globe Corner Brick Bombay

10x38x2-2,5cm - 3 7/8"x15x3/4"-1"
100060209 - L153201651 - G-252



SLATE / PIZARRA / ARDOISE

No supported grouting / No admite rejuntado /
Ne peut pas être jointoyé.

Pcs	m2	Kg
10 x Cj 420 x Pal	0,38 x Cj 15,96 x Pal	24,43 x Cj 1026,06 x Pal



Globe Brick Lhasa

10x40x2-2,5cm - 3 7/8"x15 3/4x3/4"-1"
100001584 - L153201511 - G-270



QUARTZITE / CUARCITA / QUARTZITE

No supported grouting / No admite rejuntado /
Ne peut pas être jointoyé.

Pcs	m2	Kg
10 x Cj 420 x Pal	0,40 x Cj 16,80 x Pal	24,32 x Cj 1021,44 x Pal



Globe Stick Nepal

10x40x2-2,5cm - 3 7/8"x15 3/4x3/4"-1"
100001565 - L151701001 - G-257



SLATE / PIZARRA / ARDOISE

No supported grouting / No admite rejuntado /
Ne peut pas être jointoyé.

Pcs	m2	Kg
12 x Cj 504 x Pal	0,48 x Cj 20,16 x Pal	20,38 x Cj 856,29 x Pal



Globe Stick Bhutan

10x40x2-2,5cm - 3 7/8"x15 3/4x3/4"-1"
100001566 - L151701021 - G-263



SLATE / PIZARRA / ARDOISE

No supported grouting / No admite rejuntado /
Ne peut pas être jointoyé.

Pcs	m2	Kg
12 x Cj 504 x Pal	0,48 x Cj 20,16 x Pal	20,38 x Cj 856,29 x Pal



Globe Corner Brick Lhasa

10x38x2-2,5cm - 3 7/8"x15x3/4"-1"
100032196 - L153201561 - G-272



QUARTZITE / CUARCITA / QUARTZITE

No supported grouting / No admite rejuntado /
Ne peut pas être jointoyé.

Pcs	m2	Kg
10 x Cj 420 x Pal	0,38 x Cj 15,96 x Pal	19,77 x Cj 830,34 x Pal



Globe Corner Stick Nepal

10x40x2-2,5cm - 3 7/8"x15 3/4x3/4"-1"
100032191 - L153201601 - G-260



SLATE / PIZARRA / ARDOISE

No supported grouting / No admite rejuntado /
Ne peut pas être jointoyé.

Pcs	m2	Kg
12 x Cj 504 x Pal	0,48 x Cj 20,16 x Pal	21,21 x Cj 891,07 x Pal



Globe Corner Stick Bhutan

10x40x2-2,5cm - 3 7/8"x15 3/4x3/4"-1"
100032195 - L153201621 - G-265



SLATE / PIZARRA / ARDOISE

No supported grouting / No admite rejuntado /
Ne peut pas être jointoyé.

Pcs	m2	Kg
12 x Cj 504 x Pal	0,48 x Cj 20,16 x Pal	21,21 x Cj 891,07 x Pal

Globe



Globe Stick Mix Nepal Bhutan
 10x40x1,2-2,5cm - 3 7/8"x15 3/4x1/2"-1"
 100099458 - L106300241 - G-255



SLATE / PIZARRA / ARDOISE

No supported grouting / No admite rejuntado /
 Ne peut pas être jointoyé.

Pcs	m2	Kg
8 x Cj 640 x Pal	0,32 x Cj 25,60 x Pal	11,92 x Cj 953,60 x Pal



Globe Stick Mix Nepal Shannan
 10x40x2-2,5cm - 3 7/8"x15 3/4x3/4"-1"
 100060207 - L153201631 - G-268



SLATE / PIZARRA / ARDOISE
 QUARTZITE / CUARCITA / QUARTZITE

No supported grouting / No admite rejuntado /
 Ne peut pas être jointoyé.

Pcs	m2	Kg
12 x Cj 504 x Pal	0,48 x Cj 20,16 x Pal	20,18 x Cj 847,73 x Pal



Globe Castle Burma
 10x40x2-2,5cm - 3 7/8"x15 3/4x3/4"-1"
 100086086 - L106300111 - G-255



QUARTZITE / CUARCITA / QUARTZITE

No supported grouting / No admite rejuntado /
 Ne peut pas être jointoyé.

Pcs	m2	Kg
10 x Cj 360 x Pal	0,40 x Cj 14,40 x Pal	21 x Cj 756 x Pal



Globe Corner Stick Mix Nepal Bhutan
 10x40x1,2-2,5cm - 3 7/8"x15 3/4x1/2"-1"
 100114595 - L108020671 - G-257



SLATE / PIZARRA / ARDOISE

No supported grouting / No admite rejuntado /
 Ne peut pas être jointoyé.

Pcs	m2	Kg
8 x Cj 640 x Pal	0,32 x Cj 25,60 x Pal	14,14 x Cj 1131,52 x Pal



Globe Corner Stick Mix Nepal Shannan
 10x40x2-2,5cm - 3 7/8"x15 3/4x3/4"-1"
 100057245 - L106300001 - G-270



SLATE / PIZARRA / ARDOISE
 QUARTZITE / CUARCITA / QUARTZITE

No supported grouting / No admite rejuntado /
 Ne peut pas être jointoyé.

Pcs	m2	Kg
12 x Cj 504 x Pal	0,48 x Cj 20,16 x Pal	21,42 x Cj 899,64 x Pal



Globe Wall Nepal

15x54,8x1,2-3,5cm - 5 7/8"x21 5/8"x1/2"-1 3/8"
100086108 - L119165211 - G-238



SLATE / PIZARRA / ARDOISE

No supported grouting / No admite rejuntado /
Ne peut pas être jointoyé.

Pcs	m2	Kg
6 x Cj 180 x Pal	0,49 x Cj 14,80 x Pal	20,68 x Cj 620,46 x Pal



Globe Wall Bhutan

15x54,8x1,2-2,5cm - 5 7/8"x21 5/8"x1/2"-1"
100086107 - L119165231 - G-238



SLATE / PIZARRA / ARDOISE

No supported grouting / No admite rejuntado /
Ne peut pas être jointoyé.

Pcs	m2	Kg
6 x Cj 180 x Pal	0,49 x Cj 14,80 x Pal	23,34 x Cj 700,20 x Pal



Globe Wall White

15x54,8x1,2-2,5cm - 21 5/8"x5 7/8"x1/2"/1"
100096194 - L108014841 - G-249



MARBLE / MARMOL / MARBRE

No supported grouting / No admite rejuntado /
Ne peut pas être jointoyé.

Pcs	m2	Kg
6 x Cj 180 x Pal	0,49 x Cj 20,16 x Pal	28,75 x Cj 862,50 x Pal

Globe



Globe Wall Burma

15x54,8x1,2-2,5cm - 21 5/8"x5 7/8"x1/2"-1"
100099459 - L107000621 - G-246

- 
MATT
- 
IRREGULAR
TEXTURE
- 
SLIGHT
COLOR
VARIATION
- 
INDOOR
WALL
COVERING
- 
OUTDOOR
WALL
COVERING

QUARTZITE / CUARCITA / QUARTZITE

No supported grouting / No admite rejuntado /
Ne peut pas être jointoyé.

Pcs	m2	Kg
7 x Cj	0,58 x Cj	27,53 x Cj
210 x Pal	17,26 x Pal	825,93 x Pal



Globe Wall Shannan

15x54,8x1,2-2,5cm - 21 5/8"x5 7/8"x1/2"-1"
100086109 - L119165221 - G-238

- 
MATT
- 
IRREGULAR
TEXTURE
- 
MODERATE
COLOR
VARIATION
- 
INDOOR
WALL
COVERING
- 
OUTDOOR
WALL
COVERING

QUARTZITE / CUARCITA / QUARTZITE

No supported grouting / No admite rejuntado /
Ne peut pas être jointoyé.

Pcs	m2	Kg
6 x Cj	0,49 x Cj	25,02 x Cj
180 x Pal	14,80 x Pal	750,60 x Pal

STOCK



Wall Coverings Globe Wall Burma



Tectonics

—
Range
Bend

Tectonics



Tectonics Range



Description	Format	Codes	Group	Pcs	m2	Kg
Blue Sandstone	40x80x1,5-3,5cm	100203282	G-172	1 x Cj	0,32 x Cj	20,49 x Kg
	15 3/4"x31 1/2"x5/8"-1 3/8"	L107501111		40 x Pal	12,80 x Pal	819,72 x Pal
Habana Dark	40x80x1,5-3,5cm	100203203	G-172	1 x Cj	0,32 x Cj	20,49 x Kg
	15 3/4"x31 1/2"x5/8"-1 3/8"	L108045061		40 x Pal	12,80 x Pal	819,72 x Pal
Persian White	40x80x1,5-3,5cm	100203192	G-172	1 x Cj	0,32 x Cj	20,49 x Kg
	15 3/4"x31 1/2"x5/8"-1 3/8"	L108045041		40 x Pal	12,80 x Pal	819,72 x Pal

NEW

Butech: Colorstuk Rapid Gris
Butech: Colorstuk Rapid Antracita
Butech: Colorstuk Rapid Blanco



Tectonics Bend



Description	Format	Codes	Group	Pcs	m2	Kg
Blue Sandstone	40x80x1,5-3,5cm	100203186	G-172	1 x Cj	0,32 x Cj	20,49 x Kg
	15 3/4"x31 1/2"x5/8"-1 3/8"	L107501121		40 x Pal	12,80 x Pal	819,72 x Pal
Habana Dark	40x80x1,5-3,5cm	100203191	G-172	1 x Cj	0,32 x Cj	20,49 x Kg
	15 3/4"x31 1/2"x5/8"-1 3/8"	L108045071		40 x Pal	12,80 x Pal	819,72 x Pal
Persian White	40x80x1,5-3,5cm	100203187	G-172	1 x Cj	0,32 x Cj	20,49 x Kg
	15 3/4"x31 1/2"x5/8"-1 3/8"	L108045051		40 x Pal	12,80 x Pal	819,72 x Pal

NEW

Butech: Colorstuk Rapid Gris
Butech: Colorstuk Rapid Antracita
Butech: Colorstuk Rapid Blanco



Heritage

—

Aspen White Pulido
Blanco Calacatta Pulido
Statuario Altísimo
Giallo Conte
Port Monaco
Port Cannes
Onix Botafogo
Onix Lagoa
Onix Ipanema
Onix Etnia
Onix Lava

Floor Coverings Onix Lagoa / Wall Coverings Onix Lagoa



01

Heritage



Aspen White Pulido

-  GLOSS
-  SLIGHT COLOR VARIATION
-  ORIGIN EUROPE
-  INDOOR FLOORING
-  INDOOR WALL COVERING
-  SHOWER WALL COVERINGS
-  COUNTERTOPS

Description	Format	Codes	Group	Pcs	m2	Kg
Slab / Tabla / Tranche	2cm 3/4"	100200220 L108043291	G-280	-	-	-

NEW

Butech: Colorstuk Rapid Gris



Blanco Calacatta Pulido

-  GLOSS
-  SLIGHT COLOR VARIATION
-  ORIGIN EUROPE
-  INDOOR FLOORING
-  INDOOR WALL COVERING
-  SHOWER WALL COVERINGS
-  COUNTERTOPS

Description	Format	Codes	Group	Pcs	m2	Kg
Slab / Tabla / Tranche	2cm 3/4"	100156918 L108030431	G-287	-	-	-

Butech: Colorstuk Rapid Gris

Marble / Marmol / Marbre



Statuario Altissimo



Description	Format	Codes	Group	Pcs	m2	Kg
Slab / Tabla / Tranche	2cm 3/4"	100146099 L108026401	G-291	-	-	-

Butech: Colorstuk Rapid Gris



Floor Coverings Blanco Calacatta Pulido / Wall Coverings Blanco Calacatta Pulido

01

Heritage

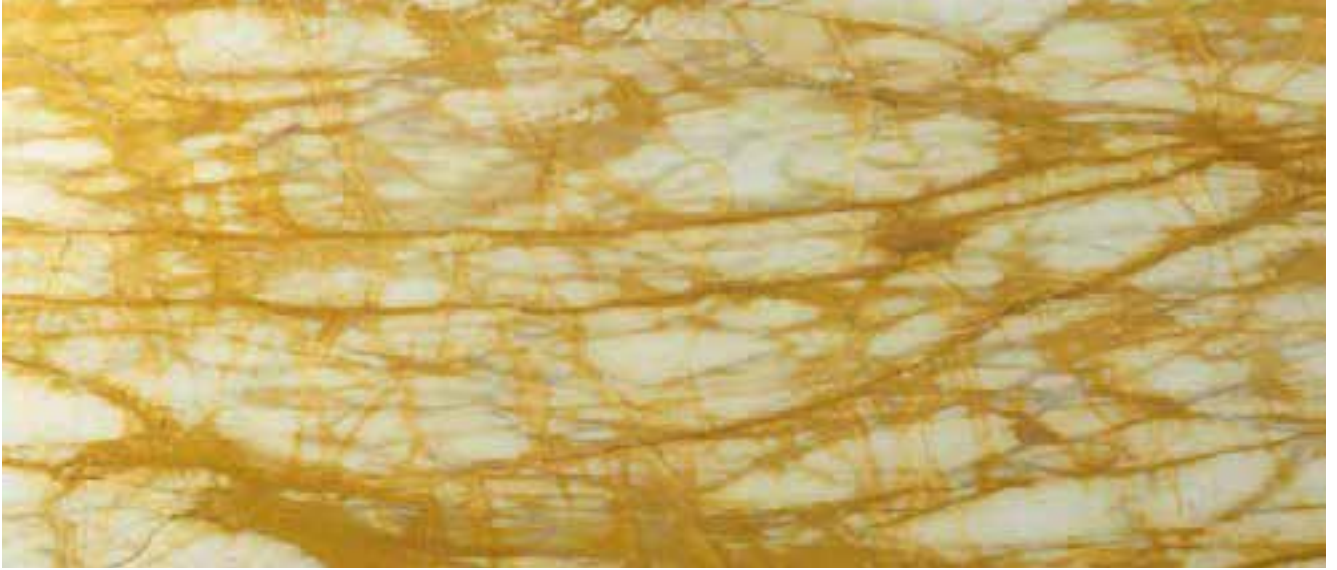

Giallo Conte

-  GLOSS
-  SLIGHT COLOR VARIATION
-  ORIGIN EUROPE
-  INDOOR FLOORING
-  INDOOR WALL COVERING
-  SHOWER WALL COVERINGS
-  COUNTERTOPS

Butech: Colorstuk Rapid Marfil

Description	Format	Codes	Group	Pcs	m2	Kg
Slab / Tabla / Tranche	2cm 3/4"	100156919 L108030461	G-289	-	-	-



Port Monaco

-  GLOSS
-  SLIGHT COLOR VARIATION
-  ORIGIN EUROPE
-  INDOOR FLOORING
-  INDOOR WALL COVERING
-  SHOWER WALL COVERINGS
-  COUNTERTOPS

Butech: Colorstuk Rapid Antracita

Description	Format	Codes	Group	Pcs	m2	Kg
Slab / Tabla / Tranche	2cm 3/4"	100157004 L108030441	G-287	-	-	-

Marble / Mrrol / Marbre



Port Cannes



Butech: Colorstuk Rapid Antracita

Description	Format	Codes	Group	Pcs	m2	Kg
Slab / Tabla / Tranche	2cm 3/4"	100157003 L108030451	G-287	-	-	-



Wall Coverings Port Cannes

01

Heritage



Onix Botafogo

-  GLOSS
-  MODERATE COLOR VARIATION
-  ORIGIN AMERICA
-  INDOOR FLOORING
-  INDOOR WALL COVERING
-  SHOWER WALL COVERINGS
-  COUNTERTOPS

Butech: Colorstuk Rapid Marfil

Description	Format	Codes	Group	Pcs	m2	Kg
Slab / Tabla / Tranche	2cm 3/4"	100157000 L108030421	G-297	-	-	-



Onix Lagoa

-  GLOSS
-  MODERATE COLOR VARIATION
-  ORIGIN ASIA
-  INDOOR FLOORING
-  INDOOR WALL COVERING
-  SHOWER WALL COVERINGS
-  COUNTERTOPS

Butech: Colorstuk Rapid Marfil

Description	Format	Codes	Group	Pcs	m2	Kg
Slab / Tabla / Tranche	2cm 3/4"	100157001 L108030471	G-295	-	-	-

Onix



Onix Ipanema

- 
MATT
- 
MODERATE
COLOR
VARIATION
- 
ORIGIN
AMERICA
- 
INDOOR
FLOORING
- 
INDOOR
WALL
COVERING
- 
SHOWER
WALL
COVERINGS
- 
COUNTERTOPS

Butech: Colorstuk Rapid Marfil

Description	Format	Codes	Group	Pcs	m2	Kg
Slab / Tabla / Tranche	2cm 3/4"	100157066 L108030531	G-297	-	-	-



Floor Coverings Onix Ipanema / Wall Coverings Onix Ipanema

01

Heritage



Onix Etnia

- 
GLOSS
- 
MODERATE
COLOR
VARIATION
- 
ORIGIN
ASIA
- 
INDOOR
FLOORING
- 
INDOOR
WALL
COVERING
- 
SHOWER
WALL
COVERINGS
- 
COUNTERTOPS

Description	Format	Codes	Group	Pcs	m2	Kg
Slab / Tabla / Tranche	2cm 3/4"	100157064 L108030571	G-297	-	-	-

Butech: Colorstuk Rapid Marfil

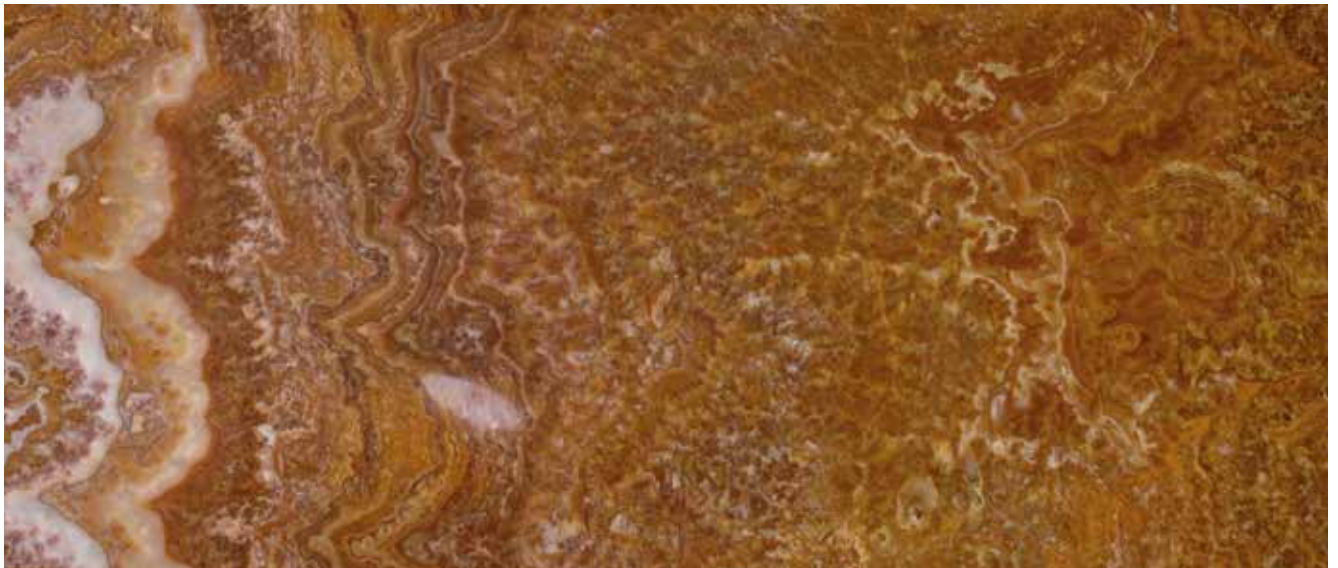

Onix Lava

- 
GLOSS
- 
MODERATE
COLOR
VARIATION
- 
ORIGIN
ASIA
- 
INDOOR
FLOORING
- 
INDOOR
WALL
COVERING
- 
SHOWER
WALL
COVERINGS
- 
COUNTERTOPS

Description	Format	Codes	Group	Pcs	m2	Kg
Slab / Tabla / Tranche	2cm 3/4"	100157067 L108030561	G-293	-	-	-

Butech: Colorstuk Rapid Marron

Onix





DQS

-
- Black
- Grey
- White

01

DQS



DQS Black



Description	Format	Codes	Group	Pcs	m2	Kg
DQS Black	60x60x1cm 23 5/8"x23 5/8"x3/8"	100096053 L107000471	G-276	3 x Cj 96 x Pal	1,08 x Cj 34,56 x Pal	27,56 x Cj 881,95 x Pal



Butech: Colorstuk 0-4 Negro + CI-Stuk

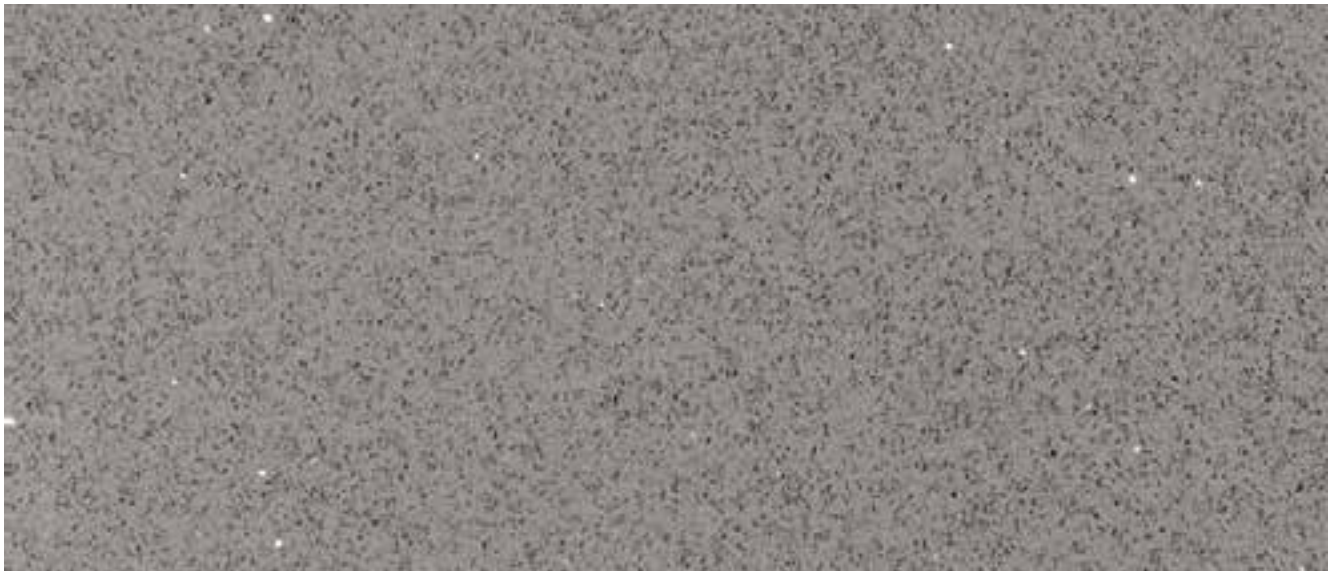

DQS Grey



Description	Format	Codes	Group	Pcs	m2	Kg
DQS Grey	60x60x1cm 23 5/8"x23 5/8"x3/8"	100096055 L107000491	G-276	3 x Cj 96 x Pal	1,08 x Cj 34,56 x Pal	27,56 x Cj 881,95 x Pal

Butech: Colorstuk 0-4 Cemento + CI-Stuk

DQS



DQS White

- 
GLOSS
- 
SLIGHT
COLOR
VARIATION
- 
ORIGIN
EUROPE
- 
INDOOR
FLOORING
- 
INDOOR
WALL
COVERING
- 
SHOWER
WALL
COVERINGS
- 
COUNTERTOPS
- 
RAMP
CLASSIFICATION











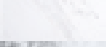



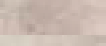



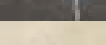
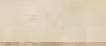

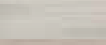





Description	Format	Codes	Group	Pcs	m2	Kg
DQS White	60x60x1cm 23 5/8"x23 5/8"x3/8"	100096059 L107000531	G-276	3 x Cj 96 x Pal	1,08 x Cj 34,56 x Pal	27,56 x Cj 881,95 x Pal

STOCK

Butech: Colorstuk 0-4 Blanco + Ci-Stuk

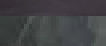
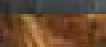

Floor Coverings DQS Grey

			Polished Pulido Polie	Classico	Home	Sand Home	Tumbled Anticato Anticato	Flamed Home	Natural	Natural Home
Marble		Blanco Almeria					•			
		Persian White	•	•						
		Blanco Carrara	•	•						
		Capadocia				•				
		Arctic White	•	•						
		Kayak Beige	•	•						
		Crema Grecia	•	•			•			
		Capuccino	•			•				
		Nairobi Crema	•	•						
		Nairobi Grey	•	•						
		Habana Grey	•	•						
		Capuccino Grey	•	•						
		Habana Brown	•	•		•				
		Habana Dark	•	•						
	Caspian Grey	•								
Travertine		Moka		•			•			
		Toscano					•			
		Silver Wood		•						
		Silk Wood		•						
		Ocean Wood		•						
Amsterd.		Amsterdam White								
		Amsterdam Beige								
		Amsterdam Grey				•				
Limestone		Calgary		•						
		Montreal		•						
		Sahara					•			
		Cream Aged					•			
		Vancouver		•						
		Ottawa	•							
Quartzite		Lagos Black			•					
		Chennai White						•		
		Sherpa Brown			•					
Sand.		Blue Sandstone		•						
		Desert Sandstone		•						
Slates		Bhutan							•	
		Patagonia		•						
		Nepal							•	
		Bombay	•							•
		Delhi	•							•
		Fidji								•
		Kathmandu	•							•

Minimum order quantity 5 slabs. Presented on trestles. / Venta mínima 5 tablas. Se sirven en caballetes. / Vente minimum 5 planches. Fournies sur chevalets.

Product Range / Gama de Producto / Gamme de Produit

160x60cm	80x80cm	60x90cm	60x60cm	40x80cm	30x60cm	10x60cm	9,8x30cm	7,5x30cm	10x25cm	55/40/25x10cm	Hexagon 19x19cm	Multiformat Multiformato Multiformat	*Slab / Tabla / Slab 2cm	*Slab / Tabla / Slab 3cm
					•									
			•	•	•		•						•	•
			•		•		•							
					•									
				•	•		•						•	•
			•	•	•								•	•
			•	•	•		•						•	•
			•	•	•								•	•
			•	•	•								•	•
				•	•								•	
				•	•		•						•	•
			•	•	•								•	•
				•	•								•	
			•	•	•								•	•
				•	•								•	•
			•	•	•								•	•
				•	•								•	•
			•	•	•							•		
	•			•									•	•
			•	•	•									
			•	•	•								•	•
													•	
				•	•								•	•
			•	•	•								•	•
			•	•	•								•	•
				•	•								•	•
				•	•								•	•
•			•		•									
		•			•									
				•	•									
				•	•									
				•	•									
				•	•									
				•	•									
				•	•									
				•	•									
				•	•									

01

Cleaning and Maintenance / Productos de Limpieza y Mantenimiento / Nettoyage et Entretien



Concentrated neutral detergent ideal for washing after laying the natural stone paving. / Detergente neutro concentrado ideal para el lavado después de la colocación de los pavimentos de piedra natural. / Détergent neutre concentré idéal pour le lavage après la pose des revêtements en pierre naturelle.

Fila Cleaner 1L

100093624 - L180300233 - G-134

Dilution / Dilución / Diluer 1:200
One litre covers / Rendimiento / Rendement de 1500 m2/L



Descaler for removing grout residue and buildingsite dirt. / Desincrustante que elimina las incrustaciones producidas por la colocación y la suciedad de obra. / Désincrustant qui élimine les incrustations issues de la pose et de la saleté du chantier.

Fila Deterdek 1L

100086918 - L180300226 - G-134

Dilution / Dilución / Diluer 1:5 - 1:10
One litre covers / Rendimiento / Rendement de 20-35 m2/L



Cleaner, stain remover and wax stripper ideal for basic cleaning of acid-sensitive stone paving. / Detergente, quitamanchas y decapante ideal para la limpieza inicial de pavimentos de piedra no resistente a los ácidos. / Détergente anti-taches et décapant idéal pour le nettoyage initial de revêtements en pierre non résistants aux acides.

Fila Ps87 1L

100097854 - L180300237 - G-156

Dilution / Dilución / Diluer 1:20
One litre covers / Rendimiento / Rendement de 200 m2/L



Wax with matt finish for paving that makes cleaning and standard maintenance easier. / Cera efecto mate para pavimentos que facilita la limpieza y el mantenimiento ordinario. / Cire effet mat pour revêtements qui facilite le nettoyage et l'entretien ordinaire.

Fila Matt 1L

100086923 - L180300230 - G-156

Use without diluting / Usar sin diluir / Utiliser sans diluer
One litre covers / Rendimiento / Rendement de 20 m2/L



Glossy-look self-polishing wax for paving that makes cleaning and standard maintenance easier. / Cera auto abrillantadora efecto brillante para pavimentos que facilita la limpieza y el mantenimiento ordinario. / Cire auto-lustrante effet brillant pour revêtements qui facilite le nettoyage et l'entretien ordinaire.

Fila Longlife 1L

100086922 - L180300229 - G-156

Use without diluting / Usar sin diluir / Utiliser sans diluer
One litre covers / Rendimiento / Rendement de 30-40 m2/L



Water-based waterrepellent protection that prevents efflorescence, ageing and decomposition of the product. / Hidrófugo antisalitre base acuosa que evita el envejecimiento y la descomposición del material. / Hydrofuge anti-salpêtre à base aqueuse qui évite le vieillissement et la décomposition du matériau.

Fila Hp98 1L

100086919 - L180300227 - G-156

Use without diluting / Usar sin diluir / Utiliser sans diluer
One litre covers / Rendimiento / Rendement de 10-20 m2/L



Stain protection that does not alter original tone, texture or colour of the product. / Protector anti manchas que protege sin cambiarle el tono ni la textura, ni el color del material. / Protecteur anti-taches qui protège sans modifier le ton, la texture ou la couleur du matériau.

Fila Fob 1L

100086920 - L180300231 - G-163

Use without diluting / Usar sin diluir / Utiliser sans diluer
One litre covers / Rendimiento / Rendement de 10-20 m2/L



Anti-ageing water-repellent protection for interior and exterior surfaces. / Hidrófugo anti-envejecimiento para interiores y exteriores. / Hydrofuge anti-vieillessement pour intérieurs et extérieurs.

Fila Hydrorep 1L

100095177 - L180001173 - G-156

Use without diluting / Usar sin diluir / Utiliser sans diluer
One litre covers / Rendimiento / Rendement de 10-20 m2/L



Colour-enhancing protection for all types of polished, honed, rough and tumbled natural stone. / Protector reavivante que exalta el color original de todo tipo de piedras naturales, tanto pulida como apomazada, envejecida, abujardada, etc / Protecteur ravivant qui rehausse la couleur d'origine de tout type de pierres naturelles, qu'elles soient polies ou poncées, vieilles, bouchardées, etc.

Fila Stone Plus 1L

100086921 - L180300228 - G-163

Use without diluting / Usar sin diluir / Utiliser sans diluer
One litre covers / Rendimiento / Rendement de 15-50 m2/L



Pleasant wet-look glossy protection. / Protector que proporciona un agradable efecto mojado con brillo. / Protecteur qui offre un agréable effet mouillé brillant.

Fila Wet 1L

100098018 - L180300238 - G-156

Use without diluting / Usar sin diluir / Utiliser sans diluer
One litre covers / Rendimiento / Rendement de 10-20 m2/L



Maintenance kit for the restoration of small marble, travertine and limestone surfaces. / Kit de mantenimiento para la restauración de pequeñas superficies de mármol, travertino y caliza. / Kit d'entretien pour la restauration de petites surfaces en marbre, travertin et calcaire.

High-End Baths Maintenance Kit / Kit Mantenimiento Highend Baths / Kit D'entretien Highend Baths

100143706 - L179702365 - G-156

Use without diluting / Usar sin diluir / Utiliser sans diluer

Technical Information / Información Técnica / Informations Techniques

	Resistance to abrasion / Resistencia a la abrasión / Résistance à l'abrasion UNE-EN 14157:2005 (mm)	Determination of the Flexural strength / Módulo a la flexión / Module de flexion UNE-EN 12371:2007 (MPa)	Determination of the frost resistance / Resistencia a la flexión tras 48 ciclos (heladicidad) / Résistance à la flexion après 48 cycles (gélivité) UNE-EN 12371: 2002 (MPa)	Determination of the unpolished slip resistance value / Resistencia al deslizamiento sin pulido / Résistance au glissement sans polissage UNE-EN 1341: 2002 (USRV)
Marbles / Mármoles / Marbres	< 25.0	> 7.0	> 5.0	> 10
Travertine / Travertinos / Travertins	< 25.0	> 7.0	> 5.0	> 10
Granites / Granitos / Granites	< 17.5	> 8.0	> 7.5	> 55
Limestones / Calizas / Pierres Calcaires	< 25.0	> 7.0	> 5.0	> 15
Slates / Pizarras / Ardoises	< 39.0	> 21.0	> 7.0	> 25
Quartzites / Cuarcitas / Quartzites	< 29.0	> 16.5	> 10.5	> 45

*The technical specification of all the materials are available on request. / *Todos los materiales disponen de su ficha técnica específica bajo solicitud / *Tous les matériaux sont fournis sur demande accompagnés de leur fiche technique.



Wall Coverings Habana Dark Classico

01

Stairs / Escaleras / Escaliers

TREAD RISER - TREAD RISER ON TEMPLATE / HUELLA TABICA - HUELLA TABICA SOBRE PLANTILLA / MARCHE CONTRE MARCHE - MARCHE CONTREMARCHE SUR GABARIT

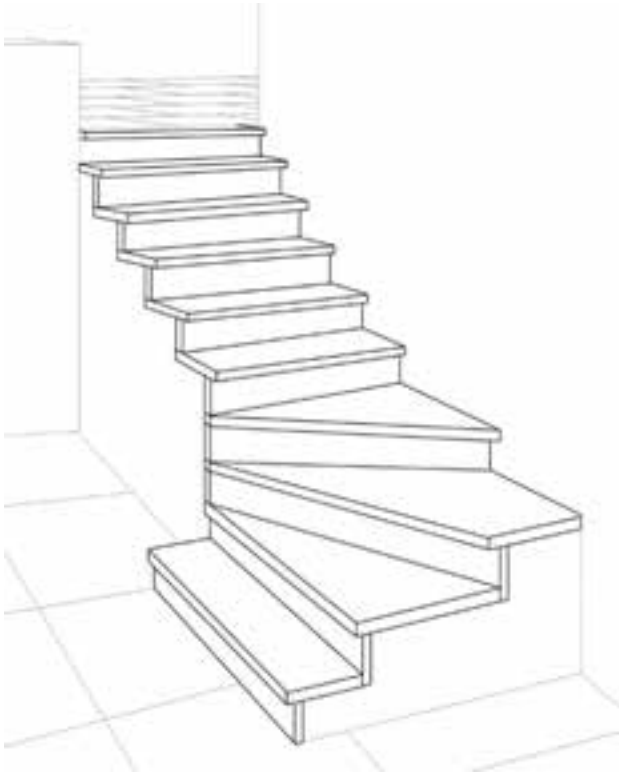

TREAD RISER - CIRCULAR TREAD / HUELLA TABICA - HUELLA CIRCULAR / MARCHE CONTRE MARCHE - MARCHE ARRONDIE



TREAD ONLY / SÓLO HUELLA / MARCHE UNIQUEMENT

FINISHES / ACABADOS / FINITIONS

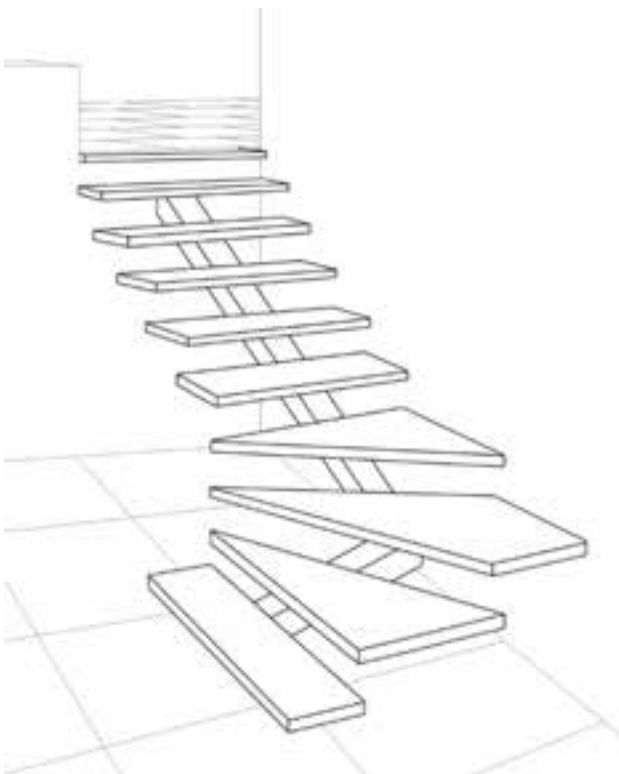

EDGES / CANTOS / BORDS

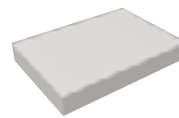

Straight / Recto / Doit

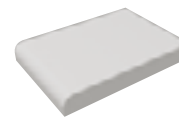

1/4 Round Edge / 1/4 Canto Redondo / 1/4 Bord Rond



1/2 Round Edge / 1/2 Canto Redondeado / 1/2 Bord Arrondi

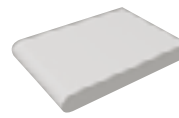

Round edge / Canto Redondeado / Bord Arrondi

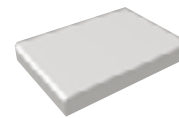

Bevelled / Biselado / Biseauté

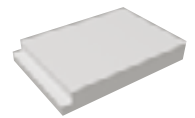

Pilaster Edge / Canto Pilastra / Bord pilastre

CUTS / CORTES / DÉCOUPES

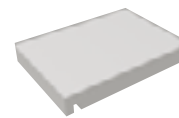

Run-off / Goterón / Larmier



01

Installation / Instalación / Installation

1. SUBSTRATE OR LAYING BASE

1. SOPORTE O FONDO DE COLOCACIÓN

1. UPPORT OU FOND DE POSE

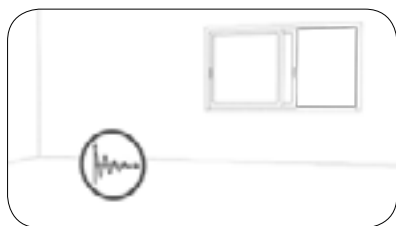

Stable and non-deformable, having undergone all the possible contractions from drying.

Estable y no deformable, habiendo completado las posibles contracciones por secado.

Stable et non déformable, avec les possibles contractions par séchage complétées.

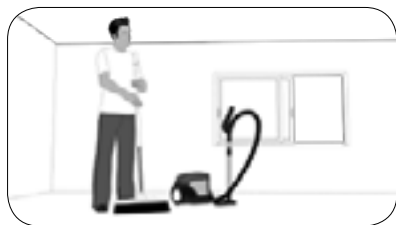

Free from dust, grease, or any substance that can compromise the adherence.

Limpio de polvo, grasas o de cualquier sustancia que pueda comprometer la adhesión.

Absence de poussière, graisse ou toute autre substance qui puisse altérer l'adhérence.

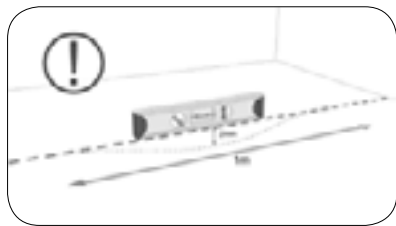

It shall not have defects in its flatness larger than 2mm.

No debe presentar defectos de planaridad superiores a 2mm.

La pièce ne doit pas présenter des défauts de planéité supérieurs à 2mm.

2. INSTALLING THE PIECES

2. COLOCACIÓN DE LAS PIEZAS

2. POSE DE PIÈCES



We recommend the adhesive

One-Flex. We recommend Butech's Super-One as adhesive for our white Marbles.

Se recomienda el adhesivo One-Flex. Para nuestros Mármoles blancos, recomendamos Super-One de Butech.

L'utilisation de l'adhésif One-Flex est recommandée. Pour nos marbres blancs, l'utilisation de Super-One de Butech est recommandée.

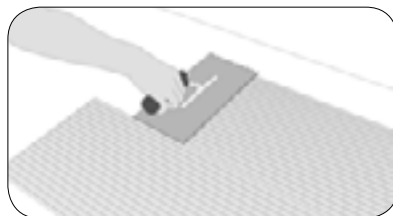

Apply with a notched trowel of an adequate size depending on the format of the piece.

Aplicar con una llana dentada del tamaño adecuado según el formato de la pieza.

Appliquer le produit avec une truelle à dents d'une dimension appropriée selon le format de la pièce.



Do not to install the tiles in contact with each other. Leave joints proportional to the dimension of the piece. For indoor applications, we recommend a minimum joint of 1.5mm, and 3mm for outdoor applications.

No colocar las baldosas en contacto entre sí. Dejar juntas proporcionales a la dimensión de la pieza. Para interiores se recomienda una junta mínima de 1,5mm y para exteriores de 3mm.

Les carreaux doivent être posés sans se toucher. Laisser des joints proportionnels à la dimension de la pièce. Il est recommandé de laisser un joint d'un minimum de 1,5mm pour les intérieurs et de 3,3mm pour les extérieurs.

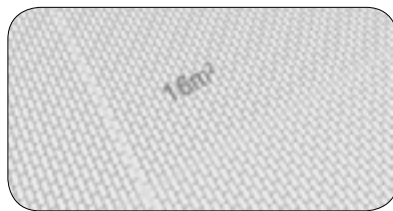

Perimeter and expansion joints shall be 1cm, and not leave a surface greater than 16m² or 8m without expansion joint.

Las juntas, perimetrales y de dilatación, serán de 1cm y no dejar una superficie superior a 16m² o 8m lineales sin junta de dilatación.

Les joints périphériques et de dilatation seront de 1cm et ne pas laisser une surface supérieure à 16m² ou 8m linéaires sans joint de dilatation.

3. SEALING INSTALLATION JOINTS

3. SELLADO DE JUNTAS DE COLOCACIÓN

3. SCÉLLEMENT DES JOINTS DE POSE

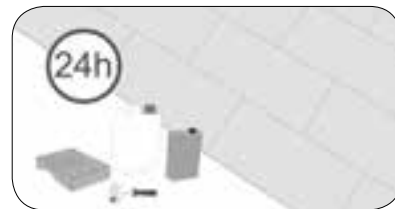

After 24 hours after the protection of the stones.

Después de 24 horas tras la protección de las piedras.

Laisser passer 24 heures après la protection des pierres.

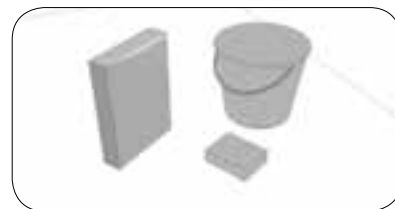

Prepare the grouting material, we recommend Colorstuck 2-12.

Preparar el material de rejuntado, recomendamos Colorstuck 2-12.

Préparer le matériel pour la réalisation des joints. Nous recommandons d'utiliser Colorstuck 2-12.

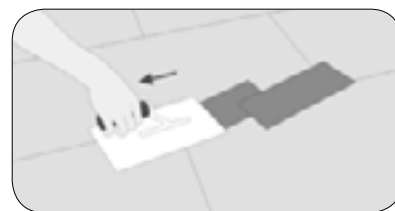

Apply the material using a hard rubber trowel, passing it repeatedly over the joints in diagonal.

Aplicar el material mediante llana de goma dura, pasándola repetidamente por las juntas en sentido diagonal.

Appliquer le matériel avec une truelle en caoutchouc dur et la passer plusieurs fois sur les joints en sens diagonal.

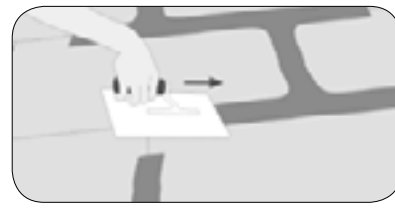

Pick the excess with the same trowel.

Recoger los sobrantes con la misma llana.

Ramasser l'excédent avec la truelle.

Installation / Instalación / Installation



Clean the surface with a thin, hard sponge, once the mortar begins to harden.

Limpiar la superficie con una esponja fina y dura una vez el mortero comienza a endurecer.

Nettoyer la surface avec une éponge fine et dure dès que le mortier commence à durcir.

4. PROTECTION OF NATURAL STONE

4. PROTECCIÓN DE LA PIEDRA NATURAL

4. PROTECTION DE LA PIERRE NATURELLE



L'Antic Colonial supplies all its natural stone products already protected, but in case it is necessary we shall proceed as follows.

L'Antic Colonial suministra todos sus productos de piedra protegidos pero, en el caso que sea necesario, proceder de la siguiente manera.

L'Antic Colonial fournit tous ses produits en pierre protégés mais, le cas échéant, il faut agir comme il suit.



The stone shall be completely clean and dry.

La piedra debe estar totalmente limpia y seca.

La pierre doit être complètement propre et sèche.



Apply the protector undiluted. Use a thin foam roller, applying two crossed layers directly on the pieces. Only one application is required. Allow to dry completely.

Aplicar el protector sin diluir. Utilizar un rodillo de espuma fina aplicado en dos capas cruzadas directamente sobre las piezas. Solo es necesaria una aplicación. Dejar secar totalmente.

Appliquer le produit non dilué. Utiliser un rouleau en mousse fine pour l'application en deux couches croisées directement sur les pièces. Une seule application est nécessaire. Laisser sécher complètement le produit.

You can see these updated installation instructions by visiting our website www.anticcolonial.com

Puedes revisar estas instrucciones de instalación actualizadas y con más detalle visitando nuestra página web www.anticcolonial.com

Pour réviser ces instructions d'installation, mises à jour et plus détaillées, veuillez visiter notre site Internet www.anticcolonial.com



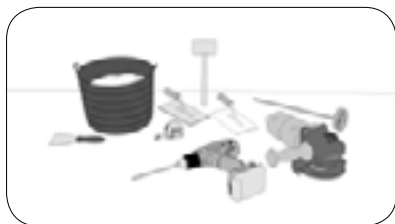

1- Material: notched trowel, rubber trowel, agitator, level, rubber mallet, circular saw, markers, meter, spatula, and adhesive paste.

1- Material: llana dentada, llana de goma, agitador, nivel, maza de goma, radial, marcadores, metro, espátula y pasta adhesiva.

1- Matériel : truelle à dents, truelle en caoutchouc, agitateur, niveau, marteau en caoutchouc, scie radiale, marqueurs, mètre, spatule et pâte adhésive.

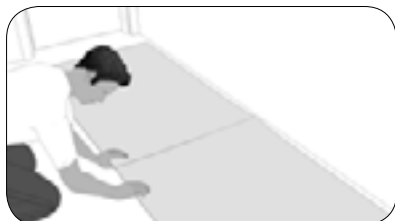

2- Before installing, protect the floor with cardboard or plastic to prevent stains.

2- Antes de la instalación proteger el suelo con cartón o plástico para evitar manchas.

2- Avant la pose, protéger le sol avec du carton ou du plastique pour éviter les taches.



3- Mark the measurements, both width and height, on the wall.

3- Marcar las medidas tanto de anchura como de altura en la pared.

3- Marquer les mesures de largeur et de hauteur sur le mur.



4- Installing sheet: using masking tape to prevent adhesive from depositing on the surface and to easily remove excess adhesive from the joints between sheets. Check with the level that it is perfectly level.

4- Colocación lámina: usar cinta carrocerero para evitar que el adhesivo

se deposite en la superficie y se quite fácilmente el exceso de adhesivo de las juntas entre láminas una vez maceadas. Comprobar con el nivel que haya quedado perfectamente nivelada.

4- Pose de la lame : utiliser du ruban adhésif de masquage pour éviter que l'adhésif adhère à la surface et pour enlever facilement l'excès d'adhésif des joints entre les lames après la pose. Vérifier avec le niveau qu'elle soit parfaitement nivelée.



5- Install with adhesive paste (we recommend Butech's Epotech), mix well before applying. Extend the glue uniformly over the entire surface with the trowel for the subsequent installation of the sheet. Once the glue is applied, install the sheet using your hand and then use the rubber trowel to set it properly and prevent air bubbles.

5- Colocar con pasta adhesiva (se recomienda Epotech de Butech), homogeneizar bien antes de aplicar. Extender la cola de manera uniforme por toda la superficie con la llana para la posterior colocación de la lámina. Una vez aplicada la cola, colocar la lámina con la mano y después usar la llana de goma o rodillo metálico para fijarla correctamente y evitar bolsos de aire.

5- La poser avec de la pâte adhésive (utilisation d'Epotech de Butech recommandée) bien homogénéisée avant l'application. Étaler la colle uniformément sur toute la surface avec la truelle pour y poser ensuite la lame. Après l'application de la colle, mettre la lame en place avec la main, puis utiliser la truelle en caoutchouc ou le rouleau métallique pour bien la fixer et éviter l'apparition de poches d'air.



6- Repeat the process with the rest of the sheets. Leaving joints is not required, but if you want to seal the joints, we recommend protecting the sides of the joints with masking tape to avoid staining the material with the product.

6- Repetir el proceso con las demás láminas. No es necesario dejar juntas aunque, si se desea sellar las juntas, recomendamos proteger los laterales

de las juntas con cinta de carrocerero para evitar manchar el material con el producto.

6- Suivre le même processus pour la pose des autres lames. Il n'est pas nécessaire de laisser des joints. Si vous souhaitez toutefois sceller les joints, nous recommandons de protéger les latéraux des joints avec du ruban adhésif de masquage pour éviter de tâcher le matériel avec le produit.



7- After installing, remove excess adhesive immediately to avoid leaving residue on the surface. Clean thoroughly with a damp cloth or paper and let dry.

7- Tras la colocación, retirar los excesos de adhesivo inmediatamente para evitar que deje restos en la superficie. Limpiar intensamente con un trapo o papel húmedo y dejar secar.

7- Après la pose, retirer immédiatement les excédents d'adhésif pour éviter qu'il adhère à la surface. Bien nettoyer avec un chiffon ou du papier humide puis laisser sécher.



8- The material is supplied protected. If you want to apply protector again, we recommend Fila Fob. Remove excess with a cloth or paper to make the application uniform.

8- El material se suministra protegido. En el caso que se quiera realizar una nueva aplicación de protector, se recomienda Fila Fob. Retirar el exceso con un trapo o papel para que la aplicación quede homogénea.

8- Le matériel est fourni protégé. Si vous souhaitez effectuer une nouvelle application du protecteur, nous recommandons l'utilisation de Fila Fob. Retirer l'excédent avec un chiffon ou un papier pour une application homogène.

You can see these updated installation instructions by visiting our website www.anticcolonial.com

Puedes revisar estas instrucciones de instalación actualizadas y con más detalle visitando nuestra página web www.anticcolonial.com

Pour réviser ces instructions d'installation, mises à jour et plus détaillées, veuillez visiter notre site Internet www.anticcolonial.com

Installation / Instalación / Installation / DQS

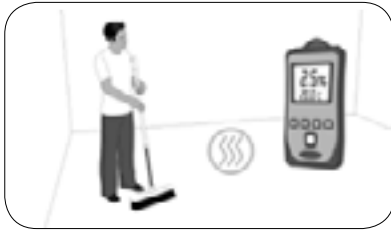

Substrates shall be completely dry (residual moisture shall not exceed 2.5%), stable, solid, resistant to compression, sufficiently leveled, and free from dust, grease, wax, paint, stripping agents, and anything else that could hinder adherence.

Soportes totalmente secos (humedad residual no superior a 2,5%), estables, sólidos, resistentes a la compresión, nivelados y libres de polvo, grasa, cera, pintura, agentes decapantes y cualquier cosa que pudiera entorpecer la adherencia.

Supports totalement secs (humidité résiduelle inférieure à 2,5 %), stables, solides, résistants à la compression, nivelés et sans poussière, graisse, peinture, agents décapants ou tout autre produit pouvant empêcher l'adhérence.

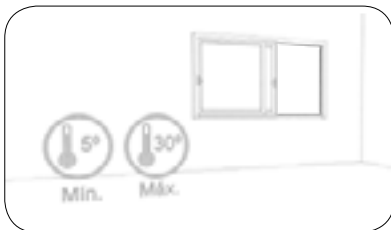

Room temperature between 5°C and 30°C.

Temperatura ambiental entre 5°C y 30°C.

Température ambiante entre 5°C et 30°C.

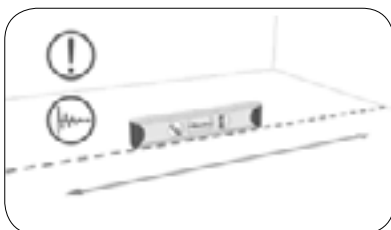

Substrate vertically aligned, properly leveled, and without defects in its flatness larger than 2mm.

Soporte aplomado, nivelado y sin defectos en su planimetría superiores a 2mm.

Le support doit être plombé, nivelé et sans défauts de planimétrie supérieurs à 2mm.



We recommend that large-size tiles be installed with the help of a suction cup.

Recomendamos que las baldosas de gran tamaño se coloquen con ayuda de una ventosa.

Il est recommandé de mettre en place les carreaux de grandes dimensions à l'aide d'une ventouse.



Lightly tap the tiles with a rubber mallet, in order to avoid the formation of air bubbles and gaps.

Golpear ligeramente las baldosas con una maza de goma para evitar la formación de burbujas de aire y espacios vacíos.

Marteler légèrement les carreaux avec un marteau en caoutchouc pour éviter la formation de bulles d'air et d'espaces vides.



A good installation and adequate vertical alignment of the tiles requires open joints using nylon spacers.

Una buena colocación y correcta alineación de las baldosas requiere juntas abiertas mediante el uso de crucetas de nailon.

Pour une bonne mise en place et un alignement correct des carreaux, placer des joints ouverts à l'aide de croisillons en nylon.

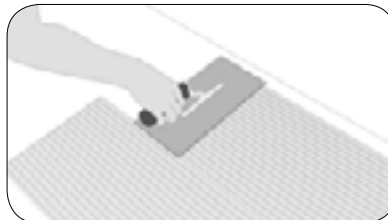

We recommend applying the Super One+Unilax adhesive with a notched trowel. Spread an amount that will cover at least 80% of the DQS tiles.

Recomendamos que se aplique el adhesivo Super One+Unilax con una llana dentada. Esparcer una cantidad que cubra al menos el 80% de las baldosas de DQS.

Il est recommandé d'appliquer l'adhésif Super One+Unilax avec une truelle à dents. Étaler une quantité qui recouvre au moins 80% des carreaux de DQS.

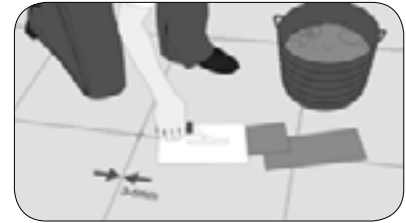

Avoid installing tiles without joints. The joint width depends on the tile size (minimum 3 to 5mm). L'Antic Colonial recommends Butech's Colorstuck 0-4 + cl-Stuk.

Evitar la colocación de baldosas sin juntas. La anchura de las juntas depende del tamaño de las baldosas (valores mínimos de 3 a 5mm). L'Antic Colonial recomienda Colorstuck 0-4 + cl-Stuk de Butech.

Ne pas mettre en place les carreaux sans joints. La largeur des joints dépend de la dimension des carreaux (valeurs minimales de 3 à 5mm). L'Antic Colonial recommande Colorstuck 0-4 + cl-Stuk de Butech.



1cm wide perimeter joint around walls and along floor surface edges with the tiles. Insert 0.5cm wide expansion joints every 40m² or every 8m.

Junta perimetral de 1cm de ancho alrededor de las paredes y los bordes de superficies de suelo con baldosas. Insertar juntas de dilatación de 0,5cm de ancho cada 40m² o cada 8m lineales.

Joint périphérique de 1cm de largeur autour des murs et des bords de surfaces de sol ayant des carreaux. Insérer les joints de dilatation de 0,5cm tous les 40m² ou tous les 8m linéaires.

You can see these updated installation instructions by visiting our website www.anticcolonial.com

Puedes revisar estas instrucciones de instalación actualizadas y con más detalle visitando nuestra página web www.anticcolonial.com

Pour réviser ces instructions d'installation, mises à jour et plus détaillées, veuillez visiter notre site Internet www.anticcolonial.com

02
1



Floor Coverings Legend 1L Light / **Wall Coverings** Calgary Classico /
Complementary Products TONO Stone Basin Wall Mounted 600 Calgary Classico, TONO Stone Mirror 800x1000 Calgary Classico

Bathrooms

All L'Antic Colonial accessories are produced from natural products which may be subject to variations in shade. The colour of the material supplied may differ slightly from that shown. Our website (<http://anticcolonial.com/banos/en/bathrooms/>) contains further information in respect of our designs, such as fitting instructions, technical specifications and drawings, details on textures or maintenance recommendations.

Todos los complementos de L'Antic Colonial están realizados con productos naturales que pueden sufrir variaciones de tono. El color del material servido puede no ser exactamente igual al de la muestra. En nuestra página web (<http://anticcolonial.com/banos/>) encontrará información adicional de nuestros diseños como instrucciones de colocación, fichas técnicas, dibujos técnicos y texturas o recomendaciones de mantenimiento.

Tous les compléments de L'Antic Colonial sont fabriqués avec des produits naturels qui peuvent subir des variations de tonalité. La couleur du matériau fourni peut être légèrement différente de celle de l'échantillon. Sur notre site Internet (<http://anticcolonial.com/fr/salles-de-bain/>), vous trouverez des informations supplémentaires sur nos créations : instructions de pose, fiches techniques, dessins techniques, textures ou recommandations pour l'entretien.

02 Made-to-measure Complementary Items / Complementos a Medida / Complements sur Mesure

L'Antic Colonial has a technical team that is specialized in making made-to-measure complementary items to meet specific project requirements.

L'Antic Colonial dispone de un equipo técnico especializado en la realización de complementos especiales a medida para adaptarse a las necesidades específicas de cada proyecto.

L'Antic Colonial dispose d'une équipe technique spécialisée dans la conception de compléments spéciaux sur mesure capables de s'adapter aux besoins spécifiques de chaque projet.

PORCELANOSA	L'ANTIC COLONIAL <small>Inspiring spaces. Inspired by nature</small>
<p>Crta. Nacional 340, Km. 54. 12540 Vila-real tel: (+34) 964 534 545 fax: (+34) 964 534 258 www.anticcolonial.com anticcolonial@anticcolonial.com</p>	01012018
	Plano Plan Plan Pianta Plano Plan Плана
	Fecha Date Date Data Data Datum Дата
Delegacion-Distribuidor Branch-Distributor Délégation-Distributeur Filiale-Distributore Delegação-Distribuidor Niederlassung-Vertriebshändler	
<input type="checkbox"/> Encimera Vanity top Tablette Top Bancada Abdeckplatte Столешница <input type="checkbox"/> Lavabo Washbasin Lavabo Lavabo Lavatório Waschtisch Умывальная раковина <input type="checkbox"/> Plato de Ducha Shower tray Receveur de douche Piatto doccia Prato de Duche Duschbecken Поддон для душа <input type="checkbox"/> Peldaño Step Marche Gradino Degrau Stufe Ступенька <input type="checkbox"/> Otros Others Autres Altri Outros Andere Прочее	
Material Material Matériau Materiale Material Material Материал	
<p>Acabado Finish Finition Finitura Acabamento Ausführung Отделка</p> <input type="checkbox"/> Pulido Polished Polie Lucidato Polido Poliirt Полировка <input type="checkbox"/> Apomazado Honed Poncée Impomciato Alisado Feingeschliffen Пемзование <input type="checkbox"/> Cepillado Brushed Brossée Spazzolato Escovado Gebürstet Обработка щеткой <input type="checkbox"/> Otros Others Autres Altri Outros Andere Прочее	
<p>Tipo de canto Edge type Type de bord Tipo di spigolo Art der Kanten Тип края</p> <input type="checkbox"/> Recto Visto Rectified Direto visto Diritto vista Droit adouci прямой угол <input type="checkbox"/> Redondeado Rounded Arrondi Arrotondato Arredondado Abgerundet Закругленный <input type="checkbox"/> 1/2 Redondeado 1/2 Rounded 1/2 Arrondi 1/2 Arrotondato 1/2 Arredondado 1/2 abgerundet 1/2 Закругленный <input type="checkbox"/> Inglete Biseau Mitre Bisellatura Gehrung Соединение под прямым углом <input type="checkbox"/> Sin cantos vistos Concealed edges Sans chants apparents Senza spigoli a vista Ohne sichtbare Kanten Без видимых краев	
Lavabo Washbasin Lavabo Lavabo Lavatório Waschtisch Умывальная раковина	
<p>Modelo, Disposición y Fabricante Model, layout and manufacturer Modèle, disposition et fabricant Modello, disposizione e produttore Modelo, Disposição e Fabricante Modell, Anbringung und Hersteller Модель, Расположение и Изготовитель</p>	
<p><small>*Incluir ficha del producto y plantilla de corte si fuera necesario para lavabos que no sean del Grupo Porcelanosa, especialmente para lavabos bajo encastre. You must attach this washbasin sheet and cutout template for washbasins not manufactured by Porcelanosa Grupo, especially for flush-mount models. The application will be sent back should this information not be included Il est obligatoire de joindre la fiche et le gabarit de coupe des vasques d'une autre marque que Porcelanosa Grupo, notamment pour les modèles à encastreer par-dessous. La demande sera repoussée si cette information n'est pas incluse Obbligatorio allegare scheda del lavabo e sagoma di taglio per i lavabi che non sono di Porcelanosa Grupo, soprattutto per i modelli sottopiano. La richiesta verrà respinta nel caso non venga inclusa tale informazione Das Datenblatt und der Abbrechstand muss für Waschbecken, die nicht von Porcelanosa Grupo stammen beigelegt werden, vor allem für die mit tiefer Einspannung. Wenn diese Information nicht beigelegt ist, wird der Antrag zurückgewiesen Обязательно вложить паспорт на умывальник и форму его врезания для умывальников, изготовленных не компанией Porcelanosa Grupo, особенно для моделей, которые встраиваются снизу. Заявка будет возвращена в случае если данная информация не будет предоставлена.</small></p>	
Plano Plan Plan Pianta Plano Plan Плана	
	
Firma Signature Signature Firma Notas Unterschrift Подпись	

*Special countertops do not include brackets / *Las encimeras especiales no incluyen soportes* / *Les tablettes spéciales sont fournies sans supports*

Description of Icons / Descripción de Iconos / Description des Icones

Special sizes can be made to meet specific customer requirements.

L´Antic Colonial recommends the use of taps with an aerator in all its washbasins to reduce splashing.

Se pueden elaborar formatos especiales adaptados a las necesidades de cada cliente.

L´Antic Colonial recomienda el uso de grifos con aireador en todos sus lavabos para reducir las salpicaduras de agua.

Possibilité de fabriquer des formats spéciaux adaptés aux besoins de chaque client.

De manière à réduire les éclaboussures d'eau, L´Antic Colonial recommande l'installation de robinets équipés d'un aérateur sur tous ses lavabos.



BIOPROT

Protection that reduces drastically the emergence of most common household bacteria.

BIOPROT

Protección que reduce radicalmente la aparición de las bacterias domésticas más comunes.

BIOPROT

Protection qui réduit de façon radicale l'apparition des bactéries domestiques les plus communes.



WASHBASIN ON SUPPORT

Washbasin installed on a countertop or cabinet.

LAVABO DE APOYO

Lavabo colocado sobre una encimera o mueble.

VASQUE À POSER

Lavabo placé sur un plan de toilette ou un meuble.



WALL-MOUNTED WASHBASIN

Washbasin that is affixed to the wall.

LAVABO SUSPENDIDO

Lavabo anclado a la pared.

LAVABO SUSPENDU

Lavabo fixé au mur.



FREE-STANDING WASHBASIN

Washbasin with a base that reaches the floor of the room.

LAVABO DE PIE

Lavabo con base que llega hasta el pavimento de la estancia.

LAVABO SUR PIED

Lavabo dont la base arrive jusqu'au sol de la pièce.



SEMI-RECESSED WASHBASIN

Embedded washbasin that cuts through the countertop partially.

LAVABO DE SEMI-ENCASTRE

Lavabo encajado que atraviesa la encimera parcialmente.

LAVABO SEMI-ENCASTRÉ

Lavabo encastré qui traverse partiellement le plan de toilette.



RECESSED WASHBASIN

Washbasin installed under the countertop.

LAVABO DE ENCASTRE

Lavabo colocado por la parte inferior de una encimera.

LAVABO ENCASTRÉ

Lavabo encastré par la partie inférieure du plan de toilette.



IRREGULAR TEXTURE

Material that stands out for having an asymmetrical surface.

TEXTURA IRREGULAR

Material que destaca por tener una superficie asimétrica.

TEXTURE IRRÉGULIÈRE

Matériau qui se distingue par sa surface asymétrique.



GLOSS

Material with surface with the ability to produce reflections.

BRILLO

Material cuya superficie tiene la capacidad de producir reflejos.

ÉCLAT

Matériau dont la surface est en mesure de produire des reflets.



MATT

Material with a gloss-free surface.

MATE

Material cuya superficie carece de brillo.

MAT

Matériau dont la surface n'est pas brillante.



Washbasin Lavabos Lavabos

—
Krabi
Phuket
Buddha
Basic Stand
Duomo Plus
Soul Hollow
Shima
Geisha
Conjunto Zen
Zeno
Trend
Core
Navona
Shape
Basic
Maya
Round
Basic

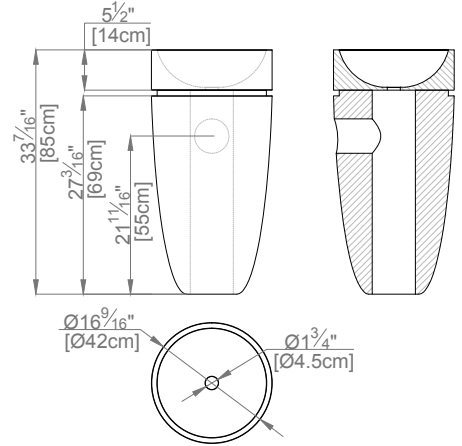

Krabi



The set includes / El conjunto incluye / L'ensemble comprend les éléments suivants:

-Wash basin / Lavabo / Lavabo
-Maintenance kit / Kit de mantenimiento / Kit d'entretien

Description	Format	Codes	Group	Pcs	Kg
Beige Classico	42x85cm 16 9/16" x 33 7/16"	100032019 L170801072	G-188	1 x Cj 1 x Pal	269 x Cj 206 Neto
Blanco Almeria Classico	42x85cm 16 9/16" x 33 7/16"	100032015 L170801063	G-188	1 x Cj 1 x Pal	269 x Cj 206 Neto
Persian White Classico	42x85cm 16 9/16" x 33 7/16"	100177083 L179702885	G-188	1 x Cj 1 x Pal	269 x Cj 206 Neto
Habana Dark Classico	42x85cm 16 9/16" x 33 7/16"	100045561 L170801102	G-188	1 x Cj 1 x Pal	269 x Cj 206 Neto
Crema Italia Classico	42x85cm 16 9/16" x 33 7/16"	100032018 L170801064	G-188	1 x Cj 1 x Pal	269 x Cj 206 Neto
Grey Stone Classico	42x85cm 16 9/16" x 33 7/16"	100045562 L170801099	G-188	1 x Cj 1 x Pal	269 x Cj 206 Neto



Qmax L/min=12 l/min (Pressure/Presión/Pression= 3 bar)

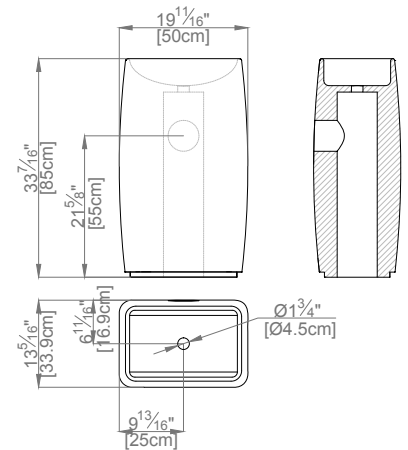

Phuket



The set includes / El conjunto incluye / L'ensemble comprend les éléments suivants:

-Wash basin / Lavabo / Lavabo
-Maintenance kit / Kit de mantenimiento / Kit d'entretien

Description	Format	Codes	Group	Pcs	Kg
Beige Classico	50x33,9x85cm 19 11/16" x 13 5/16" x 33 7/16"	100068752 L170302276	G-190	1 x Cj 1 x Pal	300 x Cj 237 Neto
Blanco Almeria Classico	50x33,9x85cm 19 11/16" x 13 5/16" x 33 7/16"	100068747 L170302275	G-190	1 x Cj 1 x Pal	300 x Cj 237 Neto
Persian White Classico	50x33,9x85cm 19 11/16" x 13 5/16" x 33 7/16"	100177066 L179702887	G-190	1 x Cj 1 x Pal	300 x Cj 237 Neto
Habana Dark Classico	50x33,9x85cm 19 11/16" x 13 5/16" x 33 7/16"	100057408 L171301061	G-190	1 x Cj 1 x Pal	300 x Cj 237 Neto
Crema Italia Classico	50x33,9x85cm 19 11/16" x 13 5/16" x 33 7/16"	100068748 L170302277	G-190	1 x Cj 1 x Pal	300 x Cj 237 Neto
Grey Stone Classico	50x33,9x85cm 19 11/16" x 13 5/16" x 33 7/16"	100068749 L170302272	G-190	1 x Cj 1 x Pal	300 x Cj 237 Neto



Qmax L/min=12 l/min (Pressure/Presión/Pression= 3 bar)

Washbasin / Lavabos / Lavabos

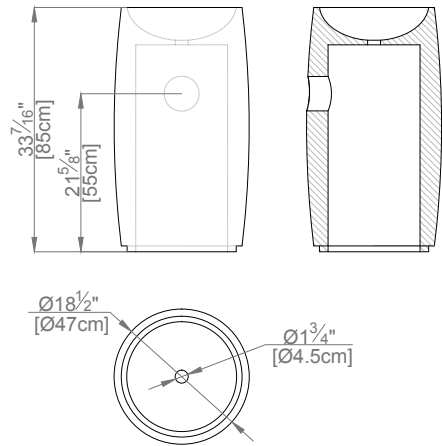

Buddha



The set includes / El conjunto incluye / L'ensemble comprend les éléments suivants:

-Wash basin / Lavabo / Lavabo
-Maintenance kit / Kit de mantenimiento / Kit d'entretien

Description	Format	Codes	Group	Pcs	Kg
Beige Classico	47øx85cm 18 1/2"øx33 7/16"	100068770 L170302393	G-192	1 x Cj 1 x Pal	297 x Cj 234 Neto
Blanco Almeria Classico	47øx85cm 18 1/2"øx33 7/16"	100062164 L171301072	G-192	1 x Cj 1 x Pal	297 x Cj 234 Neto
Persian White Classico	47øx85cm 18 1/2"øx33 7/16"	100177065 L179702880	G-192	1 x Cj 1 x Pal	297 x Cj 234 Neto
Habana Dark Classico	47øx85cm 18 1/2"øx33 7/16"	100057405 L171301060	G-192	1 x Cj 1 x Pal	297 x Cj 234 Neto
Crema Italia Classico	47øx85cm 18 1/2"øx33 7/16"	100068767 L170302400	G-192	1 x Cj 1 x Pal	297 x Cj 234 Neto
Grey Stone Classico	47øx85cm 18 1/2"øx33 7/16"	100068745 L170302388	G-192	1 x Cj 1 x Pal	297 x Cj 234 Neto

Qmax L/min=12 l/min (Pressure/Presión/Pression= 3 bar)



VACIADOR FIJO TAPA
PIEDRA COMPATIBLE USA
Included / Incluido / Inclus



Compatible with / Compatible con / Compatible avec:



USA SIFÓN PROJECT N
100209767 - N194710597
NOKEN

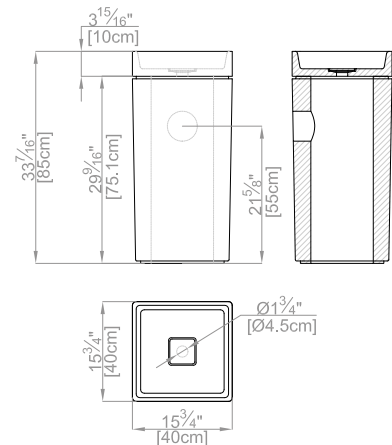

Basic Stand



The set includes / El conjunto incluye / L'ensemble comprend les éléments suivants:

-Wash basin / Lavabo / Lavabo
-Stone waste cover / Embellecedor piedra / Élément décoratif Pierre
-Maintenance kit / Kit de mantenimiento / Kit d'entretien

Description	Format	Codes	Group	Pcs	Kg
Beige Classico	40x40x85cm 15 3/4"x15 3/4"x33 7/16"	100146426 L179702409	G-193	1 x Cj 1 x Pal	294 x Cj 234 Neto
Blanco Almeria Classico	40x40x85cm 15 3/4"x15 3/4"x33 7/16"	100146424 L179702438	G-193	1 x Cj 1 x Pal	294 x Cj 234 Neto
Persian White Classico	40x40x85cm 15 3/4"x15 3/4"x33 7/16"	100177081 L179702881	G-193	1 x Cj 1 x Pal	294 x Cj 234 Neto
Habana Dark Classico	40x40x85cm 15 3/4"x15 3/4"x33 7/16"	100146488 L179702421	G-193	1 x Cj 1 x Pal	294 x Cj 234 Neto
Crema Italia Classico	40x40x85cm 15 3/4"x15 3/4"x33 7/16"	100146427 L179702431	G-193	1 x Cj 1 x Pal	294 x Cj 234 Neto
Grey Stone Classico	40x40x85cm 15 3/4"x15 3/4"x33 7/16"	100146489 L179702441	G-193	1 x Cj 1 x Pal	294 x Cj 234 Neto

Qmax L/min=12 l/min (Pressure/Presión/Pression= 3 bar)



VACIADOR FIJO
COMPATIBLE USA
Included / Incluido / Inclus



Compatible with / Compatible con / Compatible avec:



USA SIFÓN PROJECT N
100209767 - N194710597
NOKEN



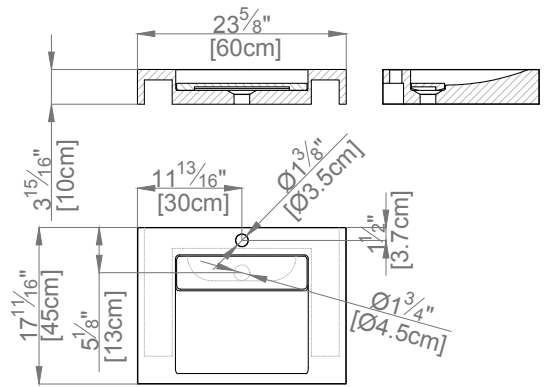

Duomo Plus



The set includes / El conjunto incluye / L'ensemble comprend les éléments suivants:

- Wash basin / Lavabo / Lavabo
- Stone waste cover / Embellecedor piedra / Élément décoratif Pierre
- Bracket / Escuadra de sujeción / Équerre de fixation
- Screws / Tornillería / Visserie

Description	Format	Codes	Group	Pcs	Kg
Beige Classico	60x45x10cm 23 5/8"x17 11/16"x3 7/8"	100113896 L170302707	G-182	1 x Cj 1 x Pal	71 x Cj 50 Neto
Blanco Almeria Classico	60x45x10cm 23 5/8"x17 11/16"x3 7/8"	100113893 L170302709	G-182	1 x Cj 1 x Pal	71 x Cj 50 Neto
Persian White Classico	60x45x10cm 23 5/8"x17 11/16"x3 7/8"	100177091 L179702879	G-182	1 x Cj 1 x Pal	71 x Cj 50 Neto
Habana Dark Classico	60x45x10cm 23 5/8"x17 11/16"x3 7/8"	100113895 L170302703	G-182	1 x Cj 1 x Pal	71 x Cj 50 Neto
Crema Italia Classico	60x45x10cm 23 5/8"x17 11/16"x3 7/8"	100113897 L170302700	G-182	1 x Cj 1 x Pal	71 x Cj 50 Neto
Grey Stone Classico	60x45x10cm 23 5/8"x17 11/16"x3 7/8"	100113899 L170302708	G-182	1 x Cj 1 x Pal	71 x Cj 50 Neto



VACIADOR FIJO COMPATIBLE USA
Included / Incluido / Inclus



Compatible with / Compatible con / Compatible avec:



USA SIFÓN PROJECT N
100209767 - N194710597
NOKEN



Qmax L/min=12 l/min (Pressure/Presión/Pression= 3 bar)

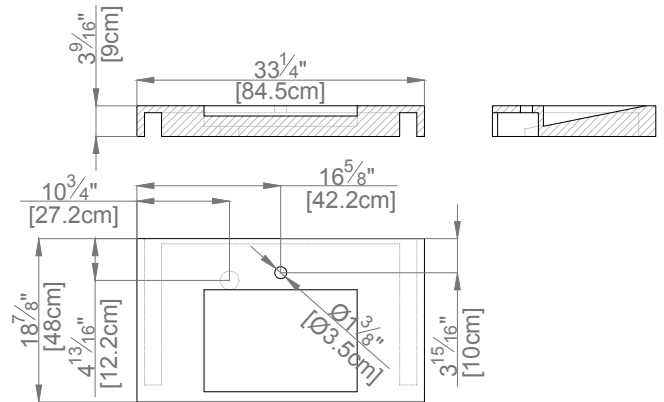

Soul Hollow



The set includes / El conjunto incluye / L'ensemble comprend les éléments suivants:

- Wash basin / Lavabo / Lavabo
- Coupling / Junta de conexión / Joint de raccordement
- Bracket / Escuadra de sujeción / Équerre de fixation
- Screws / Tornillería / Visserie

Description	Format	Codes	Group	Pcs	Kg
Beige Classico	48x84,5x9cm 18 7/8"x33 1/4"x3 9/16"	100113902 L170302701	G-183	1 x Cj 1 x Pal	120 x Cj 74 Neto
Blanco Almeria Classico	48x84,5x9cm 18 7/8"x33 1/4"x3 9/16"	100113823 L170302689	G-183	1 x Cj 1 x Pal	120 x Cj 74 Neto
Persian White Classico	48x84,5x9cm 18 7/8"x33 1/4"x3 9/16"	100177094 L179702889	G-183	1 x Cj 1 x Pal	120 x Cj 74 Neto
Habana Dark Classico	48x84,5x9cm 18 7/8"x33 1/4"x3 9/16"	100113849 L170302695	G-183	1 x Cj 1 x Pal	120 x Cj 74 Neto
Crema Italia Classico	48x84,5x9cm 18 7/8"x33 1/4"x3 9/16"	100113850 L170302698	G-183	1 x Cj 1 x Pal	120 x Cj 74 Neto
Grey Stone Classico	48x84,5x9cm 18 7/8"x33 1/4"x3 9/16"	100113903 L170302710	G-183	1 x Cj 1 x Pal	120 x Cj 74 Neto

Compatible with / Compatible con / Compatible avec:



ADAPTADOR DESAGÜE EUROPEA 6108099
100040079 - N292009900
NOKEN



USA SIFÓN PROJECT N
100209767 - N194710597
NOKEN



Qmax L/min=10 l/min (Pressure/Presión/Pression= 3 bar)

Washbasin / Lavabos / Lavabos

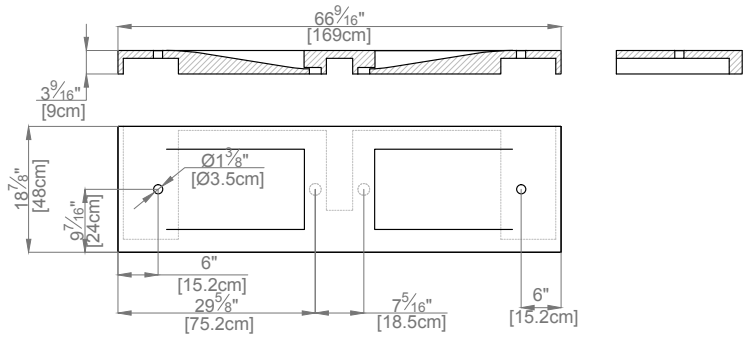

Shima



The set includes / El conjunto incluye /
L'ensemble comprend les éléments suivants:

- Wash basin / Lavabo / Lavabo
- Coupling / Junta de conexión / Joint de raccordement
- Bracket / Escuadra de sujeción / Équerre de fixation
- Screws / Tornillería / Visserie

Compatible with / Compatible con / Compatible avec:

Description	Format	Codes	Group	Pcs	Kg
Beige Classico	169x48x9cm 66 9/16"x18 7/8"x3 9/16"	100068093 L171301102	G-192	1 x Cj 1 x Pal	260 x Cj 206 Neto
Blanco Almeria Classico	169x48x9cm 66 9/16"x18 7/8"x3 9/16"	100068088 L171301106	G-192	1 x Cj 1 x Pal	260 x Cj 206 Neto
Persian White Classico	169x48x9cm 66 9/16"x18 7/8"x3 9/16"	100177067 L179702888	G-192	1 x Cj 1 x Pal	260 x Cj 206 Neto
Habana Dark Classico	169x48x9cm 66 9/16"x18 7/8"x3 9/16"	100068092 L171301101	G-192	1 x Cj 1 x Pal	260 x Cj 206 Neto
Crema Italia Classico	169x48x9cm 66 9/16"x18 7/8"x3 9/16"	100068089 L171301105	G-192	1 x Cj 1 x Pal	260 x Cj 206 Neto
Grey Stone Classico	169x48x9cm 66 9/16"x18 7/8"x3 9/16"	100068102 L171301108	G-192	1 x Cj 1 x Pal	260 x Cj 206 Neto



Qmax L/min=7 l/min (Pressure/Presión/Pression= 3 bar)

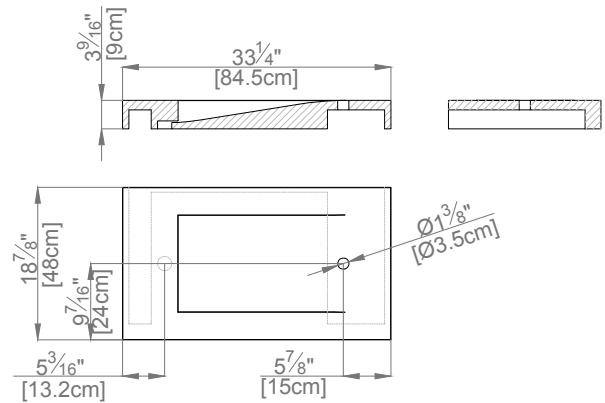

Geisha



The set includes / El conjunto incluye /
L'ensemble comprend les éléments suivants:

- Wash basin / Lavabo / Lavabo
- Coupling / Junta de conexión / Joint de raccordement
- Bracket / Escuadra de sujeción / Équerre de fixation
- Screws / Tornillería / Visserie

Compatible with / Compatible con / Compatible avec:

Description	Format	Codes	Group	Pcs	Kg
Beige Classico	84,5x48x9cm 33 1/4"x18 7/8"x3 9/16"	100068100 L170302231	G-182	1 x Cj 1 x Pal	110 x Cj 84 Neto
Blanco Almeria Classico	84,5x48x9cm 33 1/4"x18 7/8"x3 9/16"	100068095 L170302191	G-182	1 x Cj 1 x Pal	110 x Cj 84 Neto
Persian White Classico	84,5x48x9cm 33 1/4"x18 7/8"x3 9/16"	100177074 L179702884	G-182	1 x Cj 1 x Pal	110 x Cj 84 Neto
Habana Dark Classico	84,5x48x9cm 33 1/4"x18 7/8"x3 9/16"	100068098 L170302201	G-182	1 x Cj 1 x Pal	110 x Cj 84 Neto
Crema Italia Classico	84,5x48x9cm 33 1/4"x18 7/8"x3 9/16"	100068096 L170302211	G-182	1 x Cj 1 x Pal	110 x Cj 84 Neto
Grey Stone Classico	84,5x48x9cm 33 1/4"x18 7/8"x3 9/16"	100068104 L170302251	G-182	1 x Cj 1 x Pal	110 x Cj 84 Neto



Qmax L/min=7,5 l/min (Pressure/Presión/Pression= 3 bar)

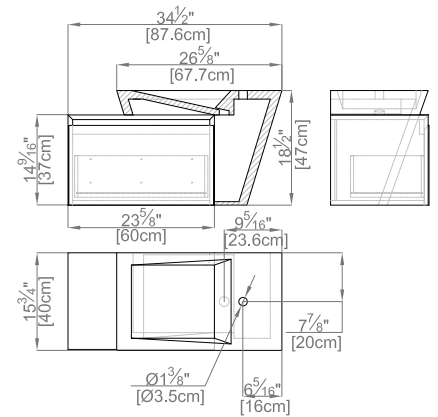

Zen Wood



MATT

WALL-MOUNTED
WASHBASIN

BIOPROT

The set includes / El conjunto incluye /
L'ensemble comprend les éléments suivants:

- Wash basin / Lavabo / Lavabo
- Coupling / Junta de conexión / Joint de raccordement
- Bracket / Escuadra de sujeción / Équerre de fixation
- Screws / Tornillería / Visserie
- Furniture / Mueble / Meuble

Compatible with / Compatible con / Compatible avec:

Description	Format	Codes	Group	Pcs	Kg
Persian White / Roble Cloudy	87,5x40x47cm 33 1/4"x18 7/8"x3 9/16"	100177277 L179702903	G-190	1 x Cj 1 x Pal	110 x Cj 90 Neto
Persian White / Nogal Intense	87,5x40x47cm 33 1/4"x18 7/8"x3 9/16"	100177295 L179702907	G-190	1 x Cj 1 x Pal	110 x Cj 90 Neto
Persian White / Roble Sunset	87,5x40x47cm 33 1/4"x18 7/8"x3 9/16"	100177303 L179702906	G-190	1 x Cj 1 x Pal	110 x Cj 90 Neto
Persian White / Nogal Warm	87,5x40x47cm 33 1/4"x18 7/8"x3 9/16"	100177286 L179702905	G-190	1 x Cj 1 x Pal	110 x Cj 90 Neto
Habana Dark / Roble Cloudy	87,5x40x47cm 33 1/4"x18 7/8"x3 9/16"	100155880 L179702549	G-190	1 x Cj 1 x Pal	110 x Cj 90 Neto
Habana Dark / Nogal Intense	87,5x40x47cm 33 1/4"x18 7/8"x3 9/16"	100110776 L170302645	G-190	1 x Cj 1 x Pal	110 x Cj 90 Neto
Habana Dark / Roble Sunset	87,5x40x47cm 33 1/4"x18 7/8"x3 9/16"	100155883 L179702555	G-190	1 x Cj 1 x Pal	110 x Cj 90 Neto
Habana Dark / Nogal Warm	87,5x40x47cm 33 1/4"x18 7/8"x3 9/16"	100110777 L170302649	G-190	1 x Cj 1 x Pal	110 x Cj 90 Neto
Beige / Roble Cloudy	87,5x40x47cm 33 1/4"x18 7/8"x3 9/16"	100155886 L179702556	G-190	1 x Cj 1 x Pal	110 x Cj 90 Neto
Beige / Nogal Intense	87,5x40x47cm 33 1/4"x18 7/8"x3 9/16"	100110778 L170302647	G-190	1 x Cj 1 x Pal	110 x Cj 90 Neto
Beige / Roble Sunset	87,5x40x47cm 33 1/4"x18 7/8"x3 9/16"	100155889 L179702559	G-190	1 x Cj 1 x Pal	110 x Cj 90 Neto
Beige / Nogal Warm	87,5x40x47cm 33 1/4"x18 7/8"x3 9/16"	100110779 L170302646	G-190	1 x Cj 1 x Pal	110 x Cj 90 Neto
Crema Italia / Roble Cloudy	87,5x40x47cm 33 1/4"x18 7/8"x3 9/16"	100155891 L179702562	G-190	1 x Cj 1 x Pal	110 x Cj 90 Neto
Crema Italia / Nogal Intense	87,5x40x47cm 33 1/4"x18 7/8"x3 9/16"	100110766 L170302650	G-190	1 x Cj 1 x Pal	110 x Cj 90 Neto
Crema Italia / Roble Sunset	87,5x40x47cm 33 1/4"x18 7/8"x3 9/16"	100155894 L179702568	G-190	1 x Cj 1 x Pal	110 x Cj 90 Neto
Crema Italia / Nogal Warm	87,5x40x47cm 33 1/4"x18 7/8"x3 9/16"	100110767 L170302651	G-190	1 x Cj 1 x Pal	110 x Cj 90 Neto

Qmax L/min=10 l/min (Pressure/Presión/Pression= 3 bar)

ADAPTADOR DESAGÜE EUROPEA 6108099
100040079 - N292009900
NOKEN



USA SIFÓN PROJECT N
100209767 - N194710597
NOKEN



SPECIFICATIONS FOR TAPS

Higher flows could lead to the overflow of the basin. We recommend using aerator 100072948 - N29999734 STANDARD AERATOR, which reduces flow to 3.5 liters/min and consequently water use. For basins with a hidden waste we recommend that the water from the tap falls between 6 and 12cm from the waste to help the water to drain correctly and avoid the basin from filling up with water.

ESPECIFICACIONES PARA LA GRIFERIA

Se recomienda el uso del aireador 100072948 - N29999734 AIREADOR ESTANDAR que reduce el caudal a 3.5 litros/min y consecuentemente el consumo de agua. En los lavabos con desagüe oculto se recomienda que la caída del agua del grifo esté entre 6 y 12 centímetros del desagüe para evitar que el agua se estanque y pueda evacuar correctamente.

SPÉCIFICATIONS POUR LA ROBINETTERIE

Il est recommandé d'utiliser l'aérateur 100072948 - N29999734 AIREADOR ESTANDAR qui réduit le débit à 3,5 litres/min et, par conséquent, la consommation d'eau. Sur les lavabos dont la bordure est invisible, il est recommandé que la chute d'eau depuis le robinet tombe entre 6 et 12cm du percement d'évacuation afin que l'eau puisse s'évacuer correctement.

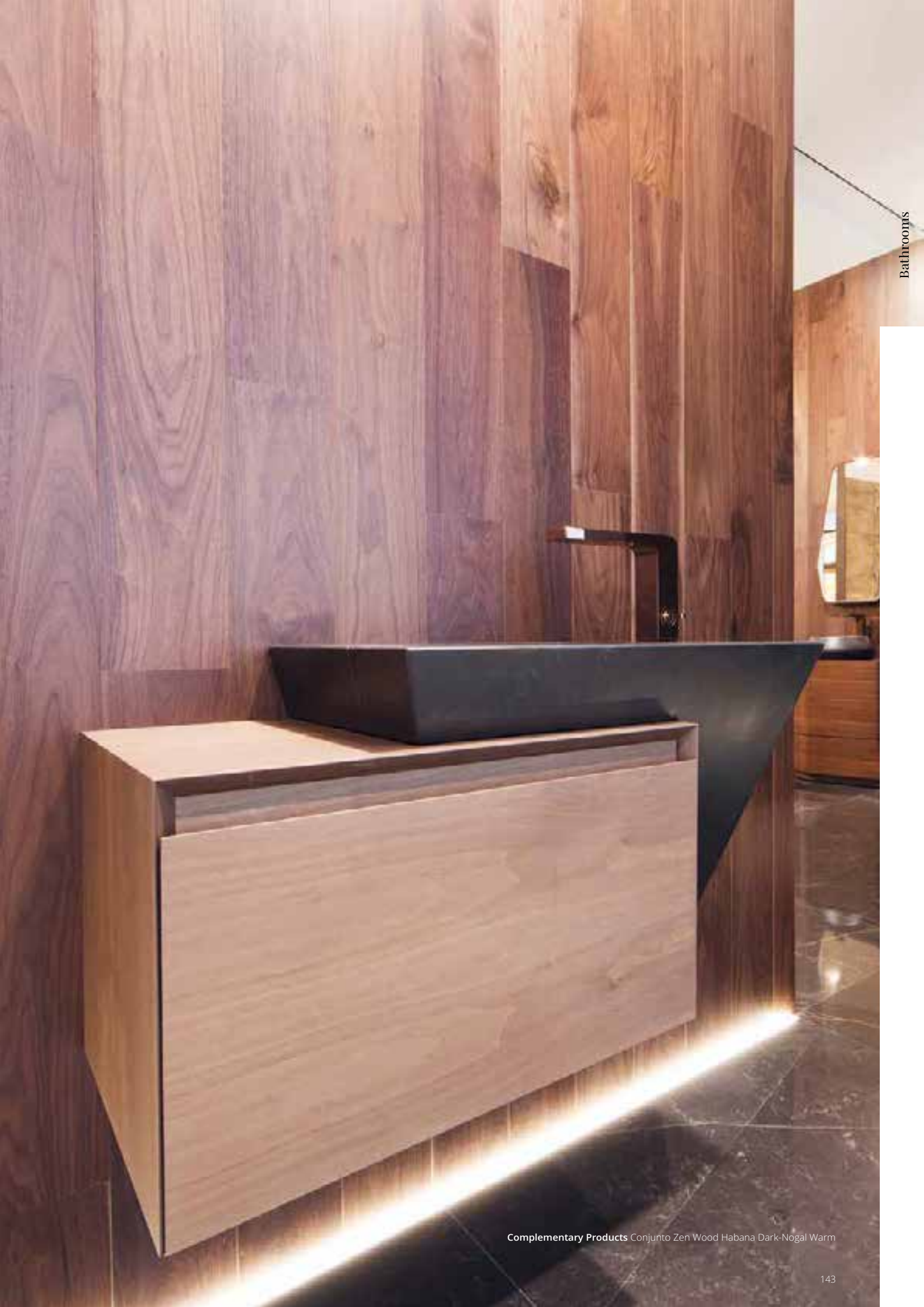

Washbasin / Lavabos / Lavabos

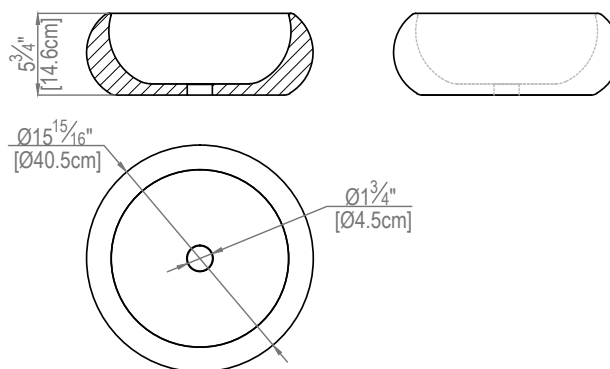

Zeno



The set includes / El conjunto incluye / L'ensemble comprend les éléments suivants:

-Wash basin / Lavabo / Lavabo

Description	Format	Codes	Group	Pcs	Kg
Beige Pulido	40,5øx14,6cm 15 15/16"øx5 3/4"	100002226 L171301031	G-179	1 x Cj 6 x Pal	23 x Cj 18,70 Neto
Blanco Almeria Pulido	40,5øx14,6cm 15 15/16"øx5 3/4"	100002227 L171301041	G-179	1 x Cj 6 x Pal	23 x Cj 18,70 Neto
Persian White Pulido	40,5øx14,6cm 15 15/16"øx5 3/4"	100177077 L170302908	G-179	1 x Cj 6 x Pal	23 x Cj 18,70 Neto
Habana Dark Pulido	40,5øx14,6cm 15 15/16"øx5 3/4"	100068842 L170302383	G-179	1 x Cj 6 x Pal	23 x Cj 18,70 Neto
Crema Italia Pulido	40,5øx14,6cm 15 15/16"øx5 3/4"	100002223 L171301001	G-179	1 x Cj 6 x Pal	23 x Cj 18,70 Neto
Grey Stone Pulido	40,5øx14,6cm 15 15/16"øx5 3/4"	100068843 L170302366	G-179	1 x Cj 6 x Pal	23 x Cj 18,70 Neto



Compatible with / Compatible con / Compatible avec:



Qmax L/min=12 l/min (Pressure/Presión/Pression= 3 bar)

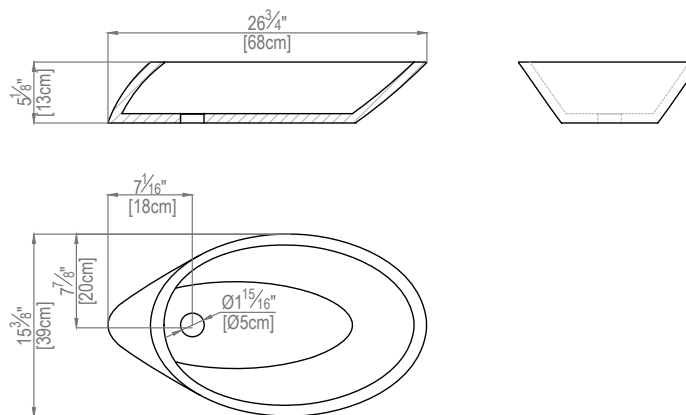

Trend



The set includes / El conjunto incluye / L'ensemble comprend les éléments suivants:

-Wash basin / Lavabo / Lavabo

Description	Format	Codes	Group	Pcs	Kg
Beige Classico	68x39x13cm 26 3/4"x15 3/8"x5 1/8"	100093140 L171301205	G-182	1 x Cj 1 x Pal	72 x Cj 48 Neto
Blanco Almeria Classico	68x39x13cm 26 3/4"x15 3/8"x5 1/8"	100093144 L171301206	G-182	1 x Cj 1 x Pal	72 x Cj 48 Neto
Persian White Classico	68x39x13cm 26 3/4"x15 3/8"x5 1/8"	100177076 L179702916	G-182	1 x Cj 1 x Pal	72 x Cj 48 Neto
Habana Dark Classico	68x39x13cm 26 3/4"x15 3/8"x5 1/8"	100093145 L171301209	G-182	1 x Cj 1 x Pal	72 x Cj 48 Neto
Crema Italia Classico	68x39x13cm 26 3/4"x15 3/8"x5 1/8"	100093146 L171301211	G-182	1 x Cj 1 x Pal	72 x Cj 48 Neto
Grey Stone Classico	68x39x13cm 26 3/4"x15 3/8"x5 1/8"	100093148 L171301210	G-182	1 x Cj 1 x Pal	72 x Cj 48 Neto



Compatible with / Compatible con / Compatible avec:



Qmax L/min=12 l/min (Pressure/Presión/Pression= 3 bar)

Washbasin / Lavabos / Lavabos

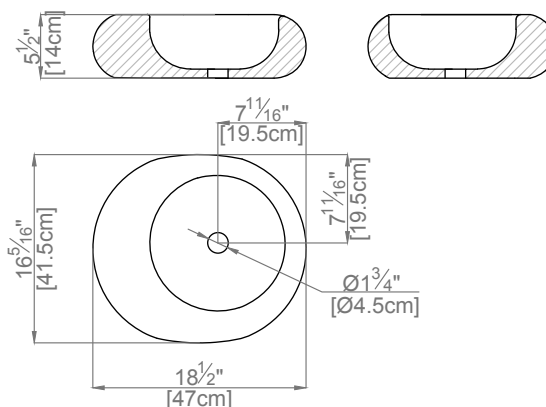

Core



The set includes / El conjunto incluye / L'ensemble comprend les éléments suivants:

-Wash basin / Lavabo / Lavabo

Description	Format	Codes	Group	Pcs	Kg
Beige Classico	47x41,5x13,5cm 18 1/2"x16 5/16"x5 5/16"	100032008 L170801112	G-179	1 x Cj 6 x Pal	39 x Cj 35 Neto
Blanco Almeria Classico	47x41,5x13,5cm 18 1/2"x16 5/16"x5 5/16"	100032004 L170801074	G-179	1 x Cj 6 x Pal	39 x Cj 35 Neto
Persian White Classico	47x41,5x13,5cm 18 1/2"x16 5/16"x5 5/16"	100177082 L179702922	G-179	1 x Cj 6 x Pal	39 x Cj 35 Neto
Habana Dark Classico	47x41,5x13,5cm 18 1/2"x16 5/16"x5 5/16"	100068891 L171301128	G-179	1 x Cj 6 x Pal	39 x Cj 35 Neto
Crema Italia Classico	47x41,5x13,5cm 18 1/2"x16 5/16"x5 5/16"	100032007 L170801110	G-179	1 x Cj 6 x Pal	39 x Cj 35 Neto
Grey Stone Classico	47x41,5x13,5cm 18 1/2"x16 5/16"x5 5/16"	100068892 L171301127	G-179	1 x Cj 6 x Pal	39 x Cj 35 Neto



Qmax L/min=12 l/min (Pressure/Presión/Pression= 3 bar)

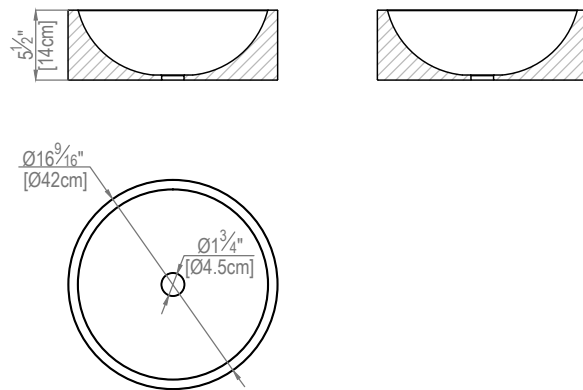

Navona



The set includes / El conjunto incluye / L'ensemble comprend les éléments suivants:

-Wash basin / Lavabo / Lavabo

Description	Format	Codes	Group	Pcs	Kg
Beige Classico	42x14cm 16 9/16"x5 1/2"	100002187 L170501004	G-176	1 x Cj 6 x Pal	37 x Cj 33 Neto
Blanco Almeria Classico	42x14cm 16 9/16"x5 1/2"	100002185 L170501001	G-176	1 x Cj 6 x Pal	37 x Cj 33 Neto
Persian White Classico	42x14cm 16 9/16"x5 1/2"	100177092 L179702932	G-176	1 x Cj 6 x Pal	37 x Cj 33 Neto
Habana Dark Classico	42x14cm 16 9/16"x5 1/2"	100068860 L170504008	G-176	1 x Cj 6 x Pal	37 x Cj 33 Neto
Crema Italia Classico	42x14cm 16 9/16"x5 1/2"	100002186 L170501002	G-176	1 x Cj 6 x Pal	37 x Cj 33 Neto
Grey Stone Classico	42x14cm 16 9/16"x5 1/2"	100068862 L170504012	G-176	1 x Cj 6 x Pal	37 x Cj 33 Neto



Qmax L/min=12 l/min (Pressure/Presión/Pression= 3 bar)

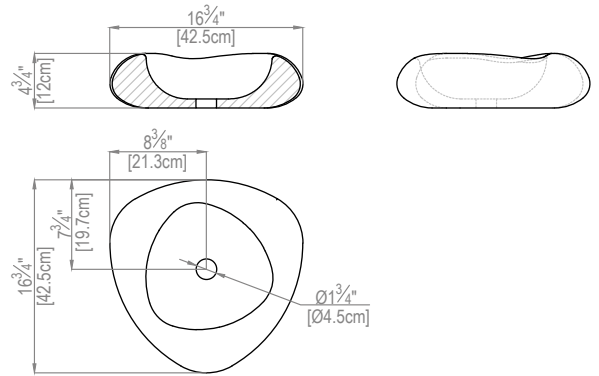

Shape



The set includes / El conjunto incluye / L'ensemble comprend les éléments suivants:

-Wash basin / Lavabo / Lavabo

Description	Format	Codes	Group	Pcs	Kg
Beige Classico	42,5x42,5x12cm 16 3/4"x16 3/4"x4 3/4"	100113817 L170302692	G-182	1 x Cj 1 x Pal	37 x Cj 33 Neto
Blanco Almeria Classico	42,5x42,5x12cm 16 3/4"x16 3/4"x4 3/4"	100113815 L170302684	G-182	1 x Cj 1 x Pal	37 x Cj 33 Neto
Persian White Classico	42,5x42,5x12cm 16 3/4"x16 3/4"x4 3/4"	100177093 L179702921	G-182	1 x Cj 1 x Pal	37 x Cj 33 Neto
Habana Dark Classico	42,5x42,5x12cm 16 3/4"x16 3/4"x4 3/4"	100113818 L170302691	G-182	1 x Cj 1 x Pal	37 x Cj 33 Neto
Crema Italia Classico	42,5x42,5x12cm 16 3/4"x16 3/4"x4 3/4"	100113819 L170302690	G-182	1 x Cj 1 x Pal	37 x Cj 33 Neto
Grey Stone Classico	42,5x42,5x12cm 16 3/4"x16 3/4"x4 3/4"	100113821 L170302694	G-182	1 x Cj 1 x Pal	37 x Cj 33 Neto



VACIADOR FIJO TAPA PIEDRA COMPATIBLE USA
Included / Incluido / Inclus



Compatible with / Compatible con / Compatible avec:



USA SIFÓN PROJECT N
100209767 - N194710597
NOKEN



Qmax L/min=12 l/min (Pressure/Presión/Pression= 3 bar)

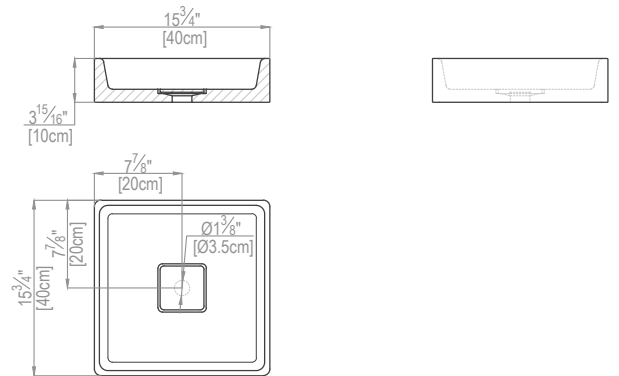

Basic



The set includes / El conjunto incluye / L'ensemble comprend les éléments suivants:

-Wash basin / Lavabo / Lavabo

-Stone waste cover / Embellecedor piedra / Élément décoratif Pierre

Description	Format	Codes	Group	Pcs	Kg
Beige Classico	40x40x10cm 15 3/4"x15 3/4"x3 15/16"	100113807 L170302688	G-179	1 x Cj 1 x Pal	26 x Cj 22 Neto
Blanco Almeria Classico	40x40x10cm 15 3/4"x15 3/4"x3 15/16"	100113790 L170302681	G-179	1 x Cj 1 x Pal	26 x Cj 22 Neto
Persian White Classico	40x40x10cm 15 3/4"x15 3/4"x3 15/16"	100177073 L179702910	G-179	1 x Cj 1 x Pal	26 x Cj 22 Neto
Habana Dark Classico	40x40x10cm 15 3/4"x15 3/4"x3 15/16"	100113791 L170302676	G-179	1 x Cj 1 x Pal	26 x Cj 22 Neto
Crema Italia Classico	40x40x10cm 15 3/4"x15 3/4"x3 15/16"	100113792 L170302674	G-179	1 x Cj 1 x Pal	26 x Cj 22 Neto
Grey Stone Classico	40x40x10cm 15 3/4"x15 3/4"x3 15/16"	100113794 L170302679	G-179	1 x Cj 1 x Pal	26 x Cj 22 Neto



VACIADOR FIJO COMPATIBLE USA
Included / Incluido / Inclus



Compatible with / Compatible con / Compatible avec:



USA SIFÓN PROJECT N
100209767 - N194710597
NOKEN



Qmax L/min=12 l/min (Pressure/Presión/Pression= 3 bar)

Washbasin / Lavabos / Lavabos

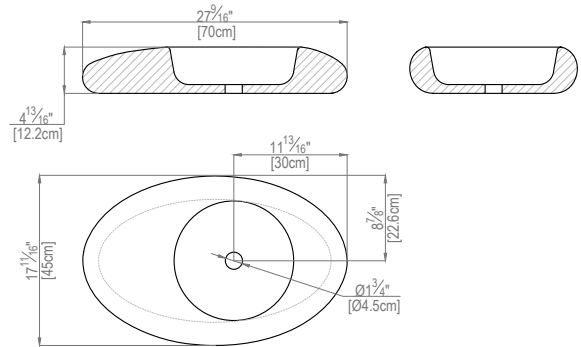

Maya



The set includes / El conjunto incluye / L'ensemble comprend les éléments suivants:

-Wash basin / Lavabo / Lavabo

Description	Format	Codes	Group	Pcs	Kg
Beige Classico	70x45x12,2cm 27 9/16x17 11/16x4 13/16"	100046874 L171801004	G-182	1 x Cj 1 x Pal	80 x Cj 56 Neto
Blanco Almeria Classico	70x45x12,2cm 27 9/16x17 11/16x4 13/16"	100046908 L171301063	G-182	1 x Cj 1 x Pal	80 x Cj 56 Neto
Persian White Classico	70x45x12,2cm 27 9/16x17 11/16x4 13/16"	100177084 L179702886	G-182	1 x Cj 1 x Pal	80 x Cj 56 Neto
Habana Dark Classico	70x45x12,2cm 27 9/16x17 11/16x4 13/16"	100068905 L170302378	G-182	1 x Cj 1 x Pal	80 x Cj 56 Neto
Crema Italia Classico	70x45x12,2cm 27 9/16x17 11/16x4 13/16"	100046872 L171801003	G-182	1 x Cj 1 x Pal	80 x Cj 56 Neto
Grey Stone Classico	70x45x12,2cm 27 9/16x17 11/16x4 13/16"	100003572 L171801001	G-182	1 x Cj 1 x Pal	80 x Cj 56 Neto



VACIADOR FIJO TAPA PIEDRA COMPATIBLE USA
Included / Includo / Inklus

Compatible with / Compatible con / Compatible avec:



USA SIFÓN PROJECT N
100209767 - N194710597
NOKEN

STOCK

Qmax L/min=12 l/min (Pressure/Presión/Pression= 3 bar)

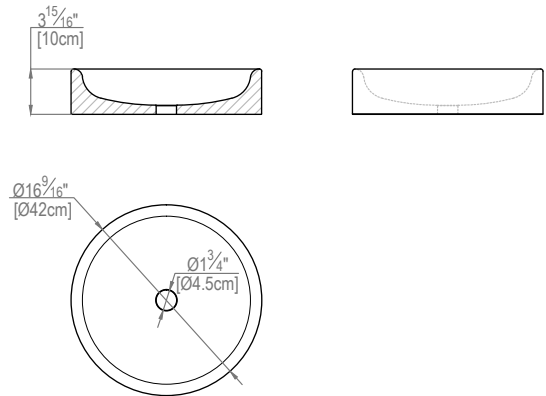

Round



The set includes / El conjunto incluye / L'ensemble comprend les éléments suivants:

-Wash basin / Lavabo / Lavabo

Description	Format	Codes	Group	Pcs	Kg
Beige Classico	42x10cm 16 9/16x16 9/16x3 15/16"	100092832 L171301191	G-178	1 x Cj 6 x Pal	25 x Cj 21 Neto
Blanco Almeria Classico	42x10cm 16 9/16x16 9/16x3 15/16"	100092828 L171301184	G-178	1 x Cj 6 x Pal	25 x Cj 21 Neto
Persian White Classico	42x10cm 16 9/16x16 9/16x3 15/16"	100177075 L170302907	G-178	1 x Cj 6 x Pal	25 x Cj 21 Neto
Habana Dark Classico	42x10cm 16 9/16x16 9/16x3 15/16"	100092840 L171301192	G-178	1 x Cj 6 x Pal	25 x Cj 21 Neto
Crema Italia Classico	42x10cm 16 9/16x16 9/16x3 15/16"	100092829 L171301183	G-178	1 x Cj 6 x Pal	25 x Cj 21 Neto
Grey Stone Classico	42x10cm 16 9/16x16 9/16x3 15/16"	100092841 L171301195	G-178	1 x Cj 6 x Pal	25 x Cj 21 Neto



VACIADOR FIJO TAPA PIEDRA COMPATIBLE USA
Included / Includo / Inklus



Compatible with / Compatible con / Compatible avec:



USA SIFÓN PROJECT N
100209767 - N194710597
NOKEN



Qmax L/min=12 l/min (Pressure/Presión/Pression= 3 bar)

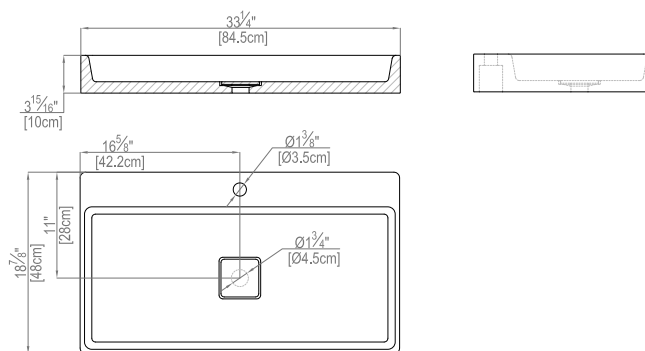

Basic H84



The set includes / El conjunto incluye / L'ensemble comprend les éléments suivants:

-Wash basin / Lavabo / Lavabo
-Stone waste cover / Embellecedor piedra / Élément décoratif Pierre

Description	Format	Codes	Group	Pcs	Kg
Beige Classico	84,5x48x10cm 33 1/4"x18 7/8"x3 15/16"	100146408 L179702396	G-185	1 x Cj 1 x Pal	84 x Cj 58 Neto
Blanco Almeria Classico	84,5x48x10cm 33 1/4"x18 7/8"x3 15/16"	100146405 L179702391	G-185	1 x Cj 1 x Pal	84 x Cj 58 Neto
Persian White Classico	84,5x48x10cm 33 1/4"x18 7/8"x3 15/16"	100177090 L179702883	G-185	1 x Cj 1 x Pal	84 x Cj 58 Neto
Habana Dark Classico	84,5x48x10cm 33 1/4"x18 7/8"x3 15/16"	100146407 L179702393	G-185	1 x Cj 1 x Pal	84 x Cj 58 Neto
Crema Italia Classico	84,5x48x10cm 33 1/4"x18 7/8"x3 15/16"	100146410 L179702395	G-185	1 x Cj 1 x Pal	84 x Cj 58 Neto
Grey Stone Classico	84,5x48x10cm 33 1/4"x18 7/8"x3 15/16"	100146409 L179702397	G-185	1 x Cj 1 x Pal	84 x Cj 58 Neto



VACIADOR FIJO COMPATIBLE USA
Included / Incluido / Inclus



Compatible with / Compatible con / Compatible avec:



USA SIFÓN PROJECT N
100209767 - N194710597
NOKEN



Qmax L/min=12 l/min (Pressure/Presión/Pression= 3 bar)

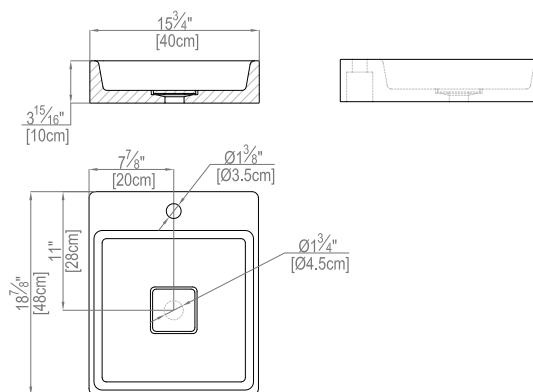

Basic H40



The set includes / El conjunto incluye / L'ensemble comprend les éléments suivants:

-Wash basin / Lavabo / Lavabo
-Stone waste cover / Embellecedor piedra / Élément décoratif Pierre

Description	Format	Codes	Group	Pcs	Kg
Beige Classico	40x48x10cm 33 1/4"x18 7/8"x3 15/16"	100146400 L179702440	G-183	1 x Cj 1 x Pal	32 x Cj 28 Neto
Blanco Almeria Classico	40x48x10cm 33 1/4"x18 7/8"x3 15/16"	100146347 L179702425	G-183	1 x Cj 1 x Pal	32 x Cj 28 Neto
Persian White Classico	40x48x10cm 33 1/4"x18 7/8"x3 15/16"	100177039 L179702882	G-183	1 x Cj 1 x Pal	32 x Cj 28 Neto
Habana Dark Classico	40x48x10cm 33 1/4"x18 7/8"x3 15/16"	100146349 L179702411	G-183	1 x Cj 1 x Pal	32 x Cj 28 Neto
Crema Italia Classico	40x48x10cm 33 1/4"x18 7/8"x3 15/16"	100146402 L179702410	G-183	1 x Cj 1 x Pal	32 x Cj 28 Neto
Grey Stone Classico	40x48x10cm 33 1/4"x18 7/8"x3 15/16"	100146401 L179702457	G-183	1 x Cj 1 x Pal	32 x Cj 28 Neto



VACIADOR FIJO COMPATIBLE USA
Included / Incluido / Inclus



Compatible with / Compatible con / Compatible avec:



USA SIFÓN PROJECT N
100209767 - N194710597
NOKEN



Qmax L/min=12 l/min (Pressure/Presión/Pression= 3 bar)

Washbasin / Lavabos / Lavabos

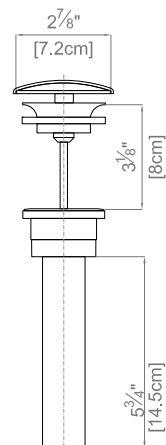

Bathrooms

Vaciador Fijo Tapa Piedra Compatible USA



Description	Format	Codes	Group	Pcs	Kg
Beige Classico	-	100222952 L179703555	G-165	1 x Cj 300 x Pal	0,51 x Cj 154,20 x Pal
Blanco Almeria Classico	-	100222933 L179703554	G-165	1 x Cj 300 x Pal	0,51 x Cj 154,20 x Pal
Persian White Classico	-	100222925 L179703559	G-165	1 x Cj 300 x Pal	0,51 x Cj 154,20 x Pal
Habana Dark Classico	-	100222924 L179703558	G-165	1 x Cj 300 x Pal	0,51 x Cj 154,20 x Pal
Crema Italia Classico	-	100222918 L179703556	G-165	1 x Cj 300 x Pal	0,51 x Cj 154,20 x Pal
Grey Stone Classico	-	100222919 L179703557	G-165	1 x Cj 300 x Pal	0,51 x Cj 154,20 x Pal

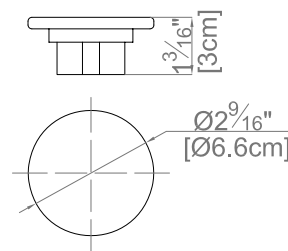

Embellecedor Lavabo



Description	Format	Codes	Group	Pcs	Kg
Beige Classico	6,6x3cm 2 9/16"x1 3/16"	100155002 L179702537	G-163	1 x Cj 50 x Pal	3,10 x Cj 155,25 x Pal
Blanco Almeria Classico	6,6x3cm 2 9/16"x1 3/16"	100154997 L179702529	G-163	1 x Cj 50 x Pal	3,10 x Cj 155,25 x Pal
Persian White Classico	6,6x3cm 2 9/16"x1 3/16"	100177129 L179702890	G-163	1 x Cj 50 x Pal	3,10 x Cj 155,25 x Pal
Habana Dark Classico	6,6x3cm 2 9/16"x1 3/16"	100155005 L179702532	G-163	1 x Cj 50 x Pal	3,10 x Cj 155,25 x Pal
Crema Italia Classico	6,6x3cm 2 9/16"x1 3/16"	100155000 L179702524	G-163	1 x Cj 50 x Pal	3,10 x Cj 155,25 x Pal
Grey Stone Classico	6,6x3cm 2 9/16"x1 3/16"	100155003 L179702527	G-163	1 x Cj 50 x Pal	3,10 x Cj 155,25 x Pal

Only compatible with / Únicamente compatible con /
Seulement compatible avec:



VACIADOR FIJO SIN REBOSADERO CROMO
100040383 - N299606001
NOKEN



Shower Trays Platos de Ducha Receveurs de Douche

—
Samui
Essence
Basic
Zen



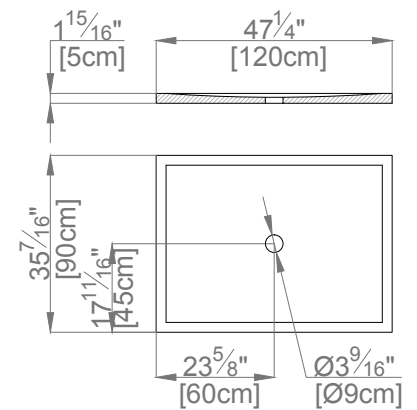

Samui



The set includes / El conjunto incluye /
L'ensemble comprend les éléments suivants:

-Shower tray / Plato de ducha / Receveur de douche
-Stone cover drain kit / Kit desagüe tapa piedra / Kit
bonde cobertura en piedra

Description	Format	Codes	Group	Pcs	Kg
Beige Classico	120x90x5cm 47 1/4"x35 7/16"x1 15/16"	100068936 L173202020	G-185	1 x Cj 1 x Pal	174 x Cj 123 Neto
Blanco Almeria Classico	120x90x5cm 47 1/4"x35 7/16"x1 15/16"	100068931 L173202023	G-185	1 x Cj 1 x Pal	174 x Cj 123 Neto
Persian White Classico	120x90x5cm 47 1/4"x35 7/16"x1 15/16"	100177160 L173300469	G-185	1 x Cj 1 x Pal	174 x Cj 123 Neto
Habana Dark Classico	120x90x5cm 47 1/4"x35 7/16"x1 15/16"	100057403 L173300082	G-185	1 x Cj 1 x Pal	174 x Cj 123 Neto
Crema Italia Classico	120x90x5cm 47 1/4"x35 7/16"x1 15/16"	100068932 L173202021	G-185	1 x Cj 1 x Pal	174 x Cj 123 Neto
Grey Stone Classico	120x90x5cm 47 1/4"x35 7/16"x1 15/16"	100068933 L173202022	G-185	1 x Cj 1 x Pal	174 x Cj 123 Neto

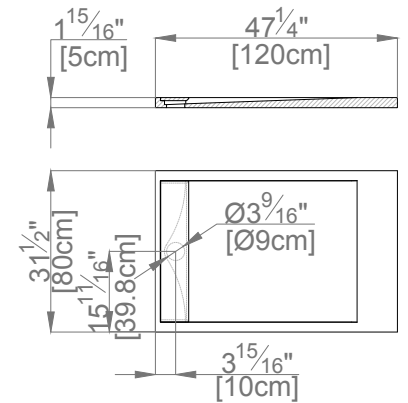

Essence



The set includes / El conjunto incluye /
L'ensemble comprend les éléments suivants:

-Shower tray / Plato de ducha / Receveur de douche
-Stone waste cover / Embellecedor piedra / Elément
décoratif Pierre
-Drain kit / Kit desagüe / Kit bonde

Description	Format	Codes	Group	Pcs	Kg
Beige Classico	120x80x5cm 47 1/4"x31 1/2"x1 15/16"	100032061 L179702036	G-186	1 x Cj 1 x Pal	172 x Cj 121 Neto
Blanco Almeria Classico	120x80x5cm 47 1/4"x31 1/2"x1 15/16"	100032057 L179702021	G-186	1 x Cj 1 x Pal	172 x Cj 121 Neto
Persian White Classico	120x80x5cm 47 1/4"x31 1/2"x1 15/16"	100177117 L173300467	G-186	1 x Cj 1 x Pal	172 x Cj 121 Neto
Habana Dark Classico	120x80x5cm 47 1/4"x31 1/2"x1 15/16"	100068930 L173500004	G-186	1 x Cj 1 x Pal	172 x Cj 121 Neto
Crema Italia Classico	120x80x5cm 47 1/4"x31 1/2"x1 15/16"	100032060 L179702026	G-186	1 x Cj 1 x Pal	172 x Cj 121 Neto
Grey Stone Classico	120x80x5cm 47 1/4"x31 1/2"x1 15/16"	100068929 L173500002	G-186	1 x Cj 1 x Pal	172 x Cj 121 Neto

Shower Trays / Platos de Ducha / Receveurs de Douche

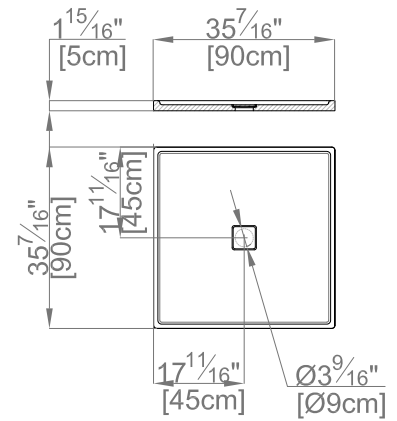

Basic



The set includes / El conjunto incluye /
L'ensemble comprend les éléments suivants:

- Shower tray / Plato de ducha / Receveur de douche
- Stone waste cover / Embellecedor piedra / Élément décoratif Pierre
- Drain kit / Kit desagüe / Kit bonde

Description	Format	Codes	Group	Pcs	Kg
Beige Classico	90x90x5cm 35 7/16"x35 7/16"x1 15/16"	100146416 L173300373	G-188	1 x Cj 1 x Pal	127 x Cj 76 Neto
Blanco Almeria Classico	90x90x5cm 35 7/16"x35 7/16"x1 15/16"	100146413 L173300374	G-188	1 x Cj 1 x Pal	127 x Cj 76 Neto
Persian White Classico	90x90x5cm 35 7/16"x35 7/16"x1 15/16"	100177136 L179702919	G-188	1 x Cj 1 x Pal	127 x Cj 76 Neto
Habana Dark Classico	90x90x5cm 35 7/16"x35 7/16"x1 15/16"	100146415 L173300375	G-188	1 x Cj 1 x Pal	127 x Cj 76 Neto
Crema Italia Classico	90x90x5cm 35 7/16"x35 7/16"x1 15/16"	100146421 L173300377	G-188	1 x Cj 1 x Pal	127 x Cj 76 Neto
Grey Stone Classico	90x90x5cm 35 7/16"x35 7/16"x1 15/16"	100146420 L173300380	G-188	1 x Cj 1 x Pal	127 x Cj 76 Neto

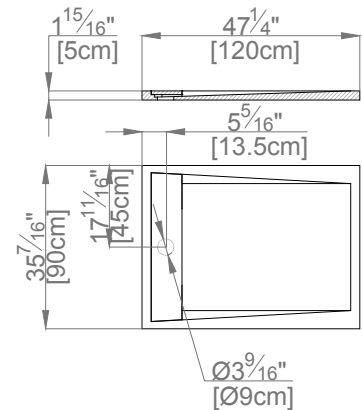

Zen



The set includes / El conjunto incluye /
L'ensemble comprend les éléments suivants:

- Shower tray / Plato de ducha / Receveur de douche
- Stone waste cover / Embellecedor piedra / Élément décoratif Pierre
- Drain kit / Kit desagüe / Kit bonde

Description	Format	Codes	Group	Pcs	Kg
Beige Classico	120x90x5cm 47 1/4"x35 7/16"x1 15/16"	100174208 L173300460	G-188	1 x Cj 1 x Pal	176 x Cj 125 Neto
Blanco Almeria Classico	120x90x5cm 47 1/4"x35 7/16"x1 15/16"	100174423 L173300458	G-188	1 x Cj 1 x Pal	176 x Cj 125 Neto
Persian White Classico	120x90x5cm 47 1/4"x35 7/16"x1 15/16"	100177170 L173300468	G-188	1 x Cj 1 x Pal	176 x Cj 125 Neto
Habana Dark Classico	120x90x5cm 47 1/4"x35 7/16"x1 15/16"	100174426 L173300463	G-188	1 x Cj 1 x Pal	176 x Cj 125 Neto
Crema Italia Classico	120x90x5cm 47 1/4"x35 7/16"x1 15/16"	100174427 L173300462	G-188	1 x Cj 1 x Pal	176 x Cj 125 Neto
Grey Stone Classico	120x90x5cm 47 1/4"x35 7/16"x1 15/16"	100174425 L173300461	G-188	1 x Cj 1 x Pal	176 x Cj 125 Neto

Bathtubs Bañeras Baignoires

Samara
Khoa
Future



02

Bathtubs / Bañeras / Baignoires

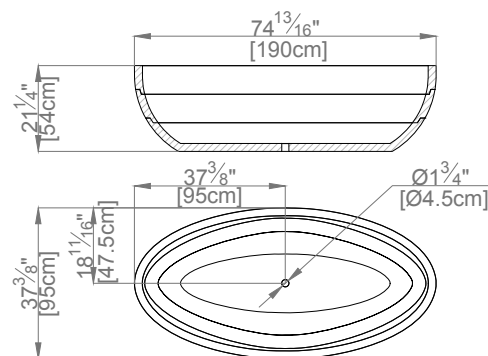

Samara



The set includes / El conjunto incluye /
L'ensemble comprend les éléments suivants:

- Bathtub / Bañera / Baignoire
- Installation kit / Kit de instalación / Kit d'installation
- Gasket / Junta de montaje / Joint de montage
- Maintenance kit / Kit de mantenimiento / Kit d'entretien

Description	Format	Codes	Group	Pcs	Kg
Persian White Classico	190x95x54cm 74 13/16"x37 3/8"x21 1/4"	100177312 L173300471	G-199	1 x Cj 1 x Pal	653 x Cj 503 Neto
Crema Italia Classico	190x95x54cm 74 13/16"x37 3/8"x21 1/4"	100177306 L173300470	G-198	1 x Cj 1 x Pal	580 x Cj 430 Neto
Habana Dark Classico	190x95x54cm 74 13/16"x37 3/8"x21 1/4"	100177307 L173300473	G-199	1 x Cj 1 x Pal	653 x Cj 503 Neto



**VACIADOR PULSADOR CLIKER SIN
REBOSADERO**

100110743 - N698350001
NOKEN



**STONE WASTE COVER
EMBELLECEDOR PIEDRA
ÉLÉMENT DÉCORATIF PIERRE**

Hidden-drain pedestals are available on order in the same material and with the same finish as that used for the bathtubs. / Los embellecedores del desagüe pueden realizarse bajo pedido con el mismo material y acabado que la bañera. / Sur demande, les éléments décoratifs du drain peuvent être fabriqués dans le même matériel et avec les mêmes finitions que le baignoires. (See page / Ver página / Voir page 157)

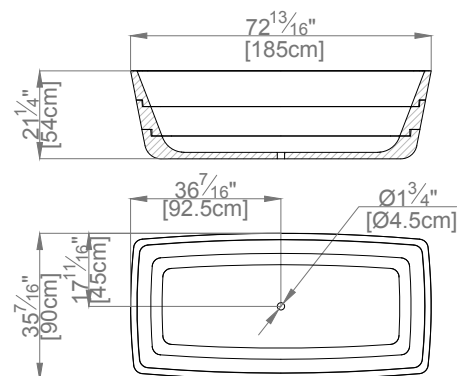

Khoa



The set includes / El conjunto incluye /
L'ensemble comprend les éléments suivants:

- Bathtub / Bañera / Baignoire
- Installation kit / Kit de instalación / Kit d'installation
- Gasket / Junta de montaje / Joint de montage
- Maintenance kit / Kit de mantenimiento / Kit d'entretien

Description	Format	Codes	Group	Pcs	Kg
Persian White Classico	185x90x54cm 72 13/16"x35 7/16"x21 1/4"	100177311 L179702923	G-199	1 x Cj 1 x Pal	675 x Cj 525 Neto
Crema Italia Classico	185x90x54cm 72 13/16"x35 7/16"x21 1/4"	100177310 L179702936	G-198	1 x Cj 1 x Pal	600 x Cj 450 Neto
Habana Dark Classico	185x90x54cm 72 13/16"x35 7/16"x21 1/4"	100177305 L179702924	G-199	1 x Cj 1 x Pal	675 x Cj 525 Neto



**VACIADOR PULSADOR CLIKER SIN
REBOSADERO**

100110743 - N698350001
NOKEN



**STONE WASTE COVER
EMBELLECEDOR PIEDRA
ÉLÉMENT DÉCORATIF PIERRE**

Hidden-drain pedestals are available on order in the same material and with the same finish as that used for the bathtubs. / Los embellecedores del desagüe pueden realizarse bajo pedido con el mismo material y acabado que la bañera. / Sur demande, les éléments décoratifs du drain peuvent être fabriqués dans le même matériel et avec les mêmes finitions que le baignoires. (See page / Ver página / Voir page 157)

Bathtubs / Bañeras / Baignoires

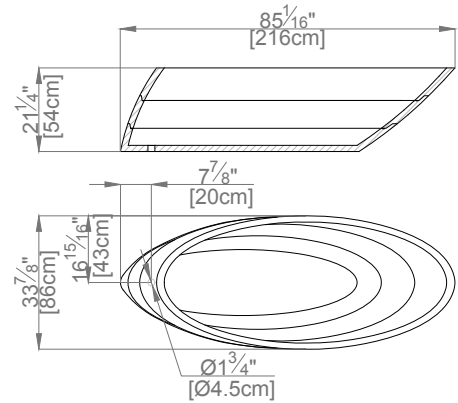

Future



The set includes / El conjunto incluye / L'ensemble comprend les éléments suivants:

- Bathtub / Bañera / Baignoires
- Installation kit / Kit de instalación / Kit d'installation
- Gasket / Junta de montaje / Joint de montage
- Maintenance kit / Kit de mantenimiento / Kit d'entretien

Description	Format	Codes	Group	Pcs	Kg
Persian White Classico	216x86x54cm 85 1/16"x33 7/8"x21 1/4"	100177279 L179702934	G-199	1 x Cj 1 x Pal	675 x Cj 525 Neto
Crema Italia Classico	216x86x54cm 85 1/16"x33 7/8"x21 1/4"	100177278 L179702917	G-198	1 x Cj 1 x Pal	600 x Cj 450 Neto
Habana Dark Classico	216x86x54cm 85 1/16"x33 7/8"x21 1/4"	100177304 L173300472	G-199	1 x Cj 1 x Pal	675 x Cj 525 Neto



VACIADOR PULSADOR CLIKER SIN REBOSADERO
100110743 - N698350001
NOKEN



STONE WASTE COVER EMBELLECEDOR PIEDRA ÉLÉMENT DÉCORATIF PIERRE
Hidden-drain pedestals are available on order in the same material and with the same finish as that used for the bathtubs. / Los embellecedores del desagüe pueden realizarse bajo pedido con el mismo material y acabado que la bañera. / Sur demande, les éléments décoratifs du drain peuvent être fabriqués dans le même matériel et avec les mêmes finitions que le baignoires. (See page / Ver página / Voir page 157)

More baths can be found on pages 187, 197 and 243
Pueden encontrar más modelos de bañeras en las páginas 187, 197 y 243
Vous trouverez d'autres modèles de baignoires aux pages 187, 197 et 243

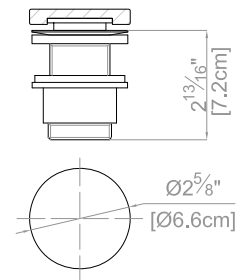

Embelledores Piedra



Description	Format	Codes	Group	Pcs	Kg
Persian White Classico	ø6,6x7,2cm ø2 5/8"x2 13/16"	100177128 L179702891	G-163	1 x Cj 50 x Pal	3,10 x Cj 155,25 x Pal
Crema Italia Classico	ø6,6x7,2cm ø2 5/8"x2 13/16"	100154992 L179702534	G-163	1 x Cj 50 x Pal	3,10 x Cj 155,25 x Pal
Habana Dark Classico	ø6,6x7,2cm ø2 5/8"x2 13/16"	100154996 L179702535	G-163	1 x Cj 50 x Pal	3,10 x Cj 155,25 x Pal



Worktops Encimeras Tablettes

—
Natural Stone
Natural Wood

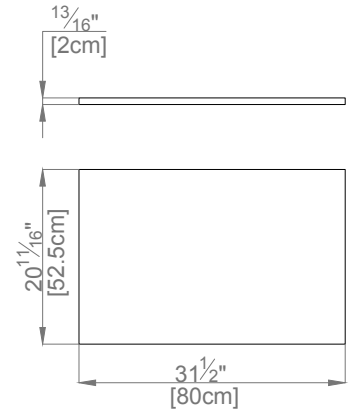

Encimera 80x52,5x2cm



MATT

IRREGULAR
TEXTURE

BIOPROT

The set includes / *El conjunto incluye /*
L'ensemble comprend les éléments suivants:

- Countertop / *Encimera / Tablettes*
- Bracket / *Escuadra de sujeción / Équerre de fixation*
- Screws / *Tornillería / Visserie*

Description	Format	Codes	Group	Pcs	Kg
Blanco Almeria Classico	80x52,5x2cm	100129000	G-173	1 x Cj	28 x Cj
	31 1/2"x20 11/16"x3/4"	L179702250		10 x Pal	23,50 Neto
Crema Italia Classico	80x52,5x2cm	100129002	G-173	1 x Cj	27 x Cj
	31 1/2"x20 11/16"x3/4"	L179702256		10 x Pal	22,50 Neto
Moka Classico	80x52,5x2cm	100129004	G-173	1 x Cj	26 x Cj
	31 1/2"x20 11/16"x3/4"	L179702254		10 x Pal	21,50 Neto
Pampa Home	80x52,5x2cm	100129008	G-173	1 x Cj	26 x Cj
	31 1/2"x20 11/16"x3/4"	L172111101		10 x Pal	24,50 Neto
Tukuman Home	80x52,5x2cm	100129014	G-173	1 x Cj	28 x Cj
	31 1/2"x20 11/16"x3/4"	L179702247		10 x Pal	23,50 Neto
Patagonia Home	80x52,5x2cm	100129011	G-173	1 x Cj	27 x Cj
	31 1/2"x20 11/16"x3/4"	L179702245		10 x Pal	22,50 Neto
Bhutan Natural	80x52,5x2cm	100128998	G-173	1 x Cj	26 x Cj
	31 1/2"x20 11/16"x3/4"	L179702253		10 x Pal	20,50 Neto

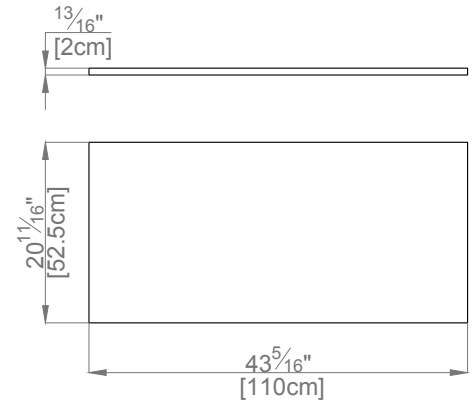

Encimera 110x52,5x2cm



MATT

IRREGULAR
TEXTURE

BIOPROT

The set includes / *El conjunto incluye /*
L'ensemble comprend les éléments suivants:

- Countertop / *Encimera / Tablettes*
- Bracket / *Escuadra de sujeción / Équerre de fixation*
- Screws / *Tornillería / Visserie*

Description	Format	Codes	Group	Pcs	Kg
Pampa Home	110x52,5x2cm	100129006	G-176	1 x Cj	37,50 x Cj
	43 5/16"x20 11/16"x3/4"	L172111061		1 x Pal	34 Neto
Tukuman Home	110x52,5x2cm	100129012	G-176	1 x Cj	36,50 x Cj
	43 5/16"x20 11/16"x3/4"	L172111081		1 x Pal	32 Neto
Patagonia Home	110x52,5x2cm	100129009	G-176	1 x Cj	35,50 x Cj
	43 5/16"x20 11/16"x3/4"	L172111071		1 x Pal	31 Neto
Bhutan Natural	110x52,5x2cm	100128999	G-176	1 x Cj	32 x Cj
	43 5/16"x20 11/16"x3/4"	L172111091		1 x Pal	27,50 Neto

Worktops / Encimeras / Tablettes

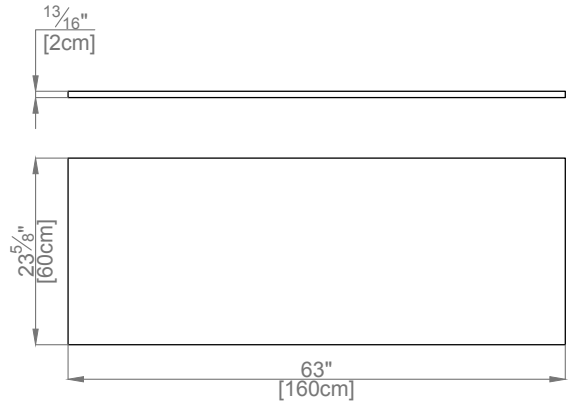

Encimera 160x60x2cm



The set includes / El conjunto incluye /
L'ensemble comprend les éléments suivants:

- Countertop / Encimera / Tablettes
- Bracket / Escuadra de sujeción / Équerre de fixation
- Screws / Tornillería / Visserie

Description	Format	Codes	Group	Pcs	Kg
Pampa Home	160x60x2cm	100129007	G-176	1 x Cj	61 x Cj
	63 1/2"x23 5/8"x3/4"	L172111051		1 x Pal	56,50 Neto
Tukuman Home	160x60x2cm	100129013	G-176	1 x Cj	58 x Cj
	63 1/2"x23 5/8"x3/4"	L172111041		1 x Pal	53,50 Neto
Patagonia Home	160x60x2cm	100129010	G-176	1 x Cj	55,50 x Cj
	63 1/2"x23 5/8"x3/4"	L172111021		1 x Pal	51 Neto

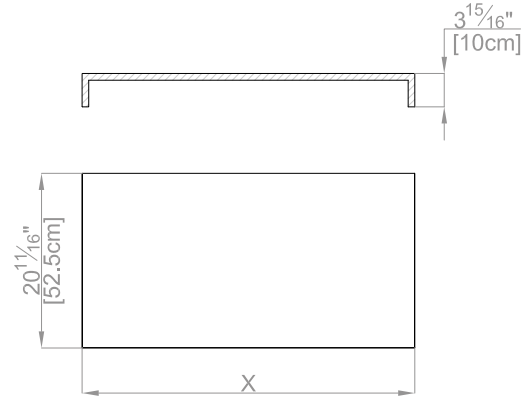

Encimera Faldon MLx52,5x10cm



The set includes / El conjunto incluye /
L'ensemble comprend les éléments suivants:

- Countertop / Encimera / Tablettes

Description	Format	Codes	Group	Pcs	Kg
Persian White Classico	MLx52,5x10cm	Pedido Especial	G-175	-	-
	MLx20 11/16"x3 15/16"	Special Order		-	-
Habana Dark Classico	MLx52,5x10cm	Pedido Especial	G-175	-	-
	MLx20 11/16"x3 15/16"	Special Order		-	-
Crema Italia Classico	MLx52,5x10cm	Pedido Especial	G-175	-	-
	MLx20 11/16"x3 15/16"	Special Order		-	-
Grey Stone Classico	MLx52,5x10cm	Pedido Especial	G-175	-	-
	MLx20 11/16"x3 15/16"	Special Order		-	-

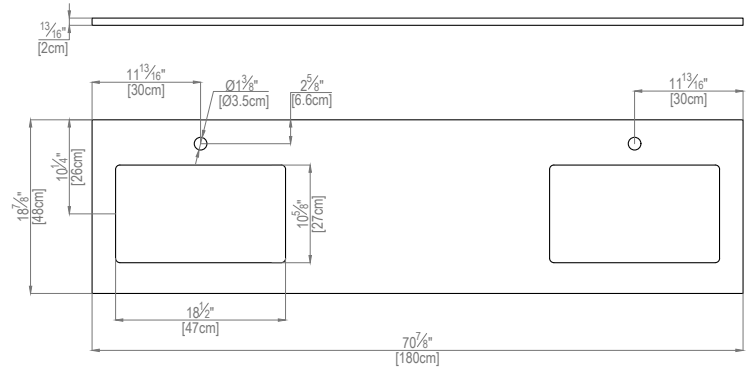

Encimera Blanco Carrara Tetris L



The set includes / El conjunto incluye / L'ensemble comprend les éléments suivants:

- Countertop / Encimera / Tablettes
- Cutout for Sotto Box wash basin / Recorte para lavabo Sotto Box / Découpe pour lavabo Sotto Box

Description	Format	Codes	Group	Pcs	Kg
Blanco Carrara	180x48x2cm 70 7/8"x18 7/8"x13/16"	100214011 L172117671	G-178	1 x Cj 1 x Pal	44,71 x Cj 44,71 Neto

Compatible with / Compatible con / Compatible avec:

- MUEBLE TETRIS 180 (GAMADECOR)
- LAVABO SOTTO BOX (GAMADEROR)

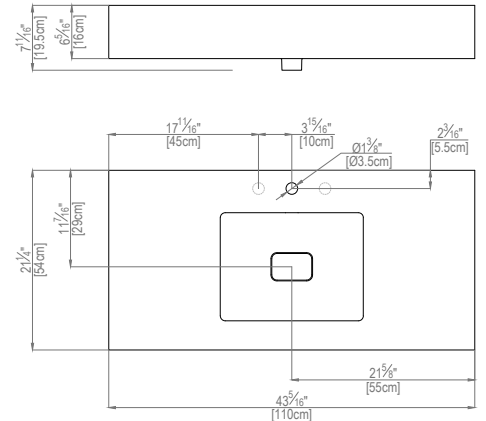

Encimera Blanco Carrara+Lav Form 110



The set includes / El conjunto incluye / L'ensemble comprend les éléments suivants:

- Forma Retto Bajo Enc. Wash basin / Lavabo Forma Retto Bajo Enc. / Lavabo Forma Retto Bajo Enc.
- Countertop / Encimera / Tablettes

Description	Format	Codes	Group	Pcs	Kg
Blanco Carrara	110x54x19,5cm 43 5/16"x21 1/4"x7 11/16"	100214010 L172117681	G-184	1 x Cj 1 x Pal	30,74 x Cj 30,74 Neto

Compatible with / Compatible con / Compatible avec:

- MUEBLE REVEL 109 (GAMADECOR)



Worktops / Encimeras / Tablettes

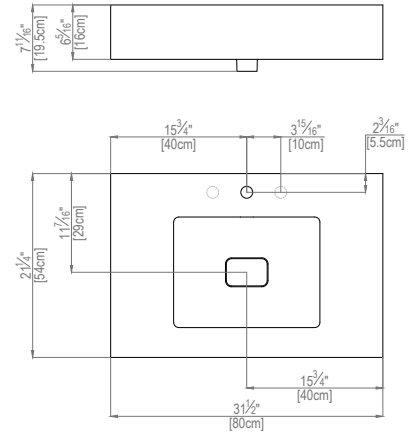

Encimera Blanco Carrara+Lav Form 80



The set includes / *El conjunto incluye* / *L'ensemble comprend les éléments suivants:*

- Forma Retto Bajo Enc. Wash basin / *Lavabo Forma Retto Bajo Enc.* / *Lavabo Forma Retto Bajo Enc.*
- Countertop / *Encimera* / *Tablettes*

Description	Format	Codes	Group	Pcs	Kg
Blanco Carrara	80x54x19,5cm 31 1/2"x21 1/4"x7 11/16"	100214012 L172117661	G-183	1 x Cj 1 x Pal	22,35 x Cj 22,35 Neto



Compatible with / *Compatible con* / *Compatible avec:*
-MUEBLE REVEL 79 (GAMADECOR)

Bathrooms



Floor Coverings Carrara Pulido / Wall Coverings Nazari Asilah / Complementary Products Encimera Blanco Carrara Lav Form 80, Essence Persian White Classico

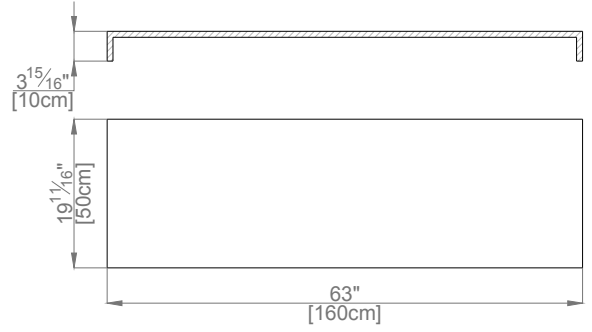

Wood Top 160



The set includes / El conjunto incluye /
L'ensemble comprend les éléments suivants:

-Countertop / Encimera / Tablettes
-Bracket / Escuadra de sujeción / Équerre de fixation
-Screws / Tornillería / Visserie

Description	Format	Codes	Group	Pcs	Kg
Nogal Intense	160x50x10	100114119	G-178	1 x Cj	17 x Cj
	63 1/2"x19 11/16"x3 15/16"	L172108791		1 x Pal	16 Neto
Nogal Warm	160x50x10	100114122	G-178	1 x Cj	17 x Cj
	63 1/2"x19 11/16"x3 15/16"	L172108731		1 x Pal	16 Neto

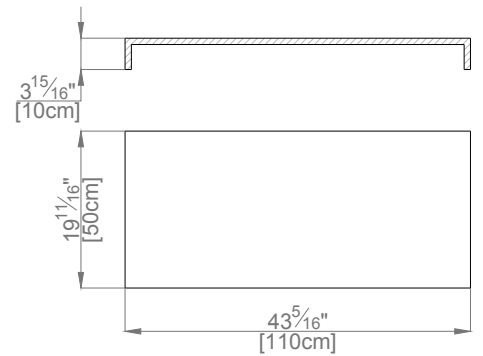

Wood Top 110



The set includes / El conjunto incluye /
L'ensemble comprend les éléments suivants:

-Countertop / Encimera / Tablettes
-Bracket / Escuadra de sujeción / Équerre de fixation
-Screws / Tornillería / Visserie

Description	Format	Codes	Group	Pcs	Kg
Nogal Intense	110x50x10	100114118	G-178	1 x Cj	12 x Cj
	43 5/16"x19 11/16"x3 15/16"	L172108771		1 x Pal	12 Neto
Nogal Warm	110x50x10	100114121	G-178	1 x Cj	13 x Cj
	43 5/16"x19 11/16"x3 15/16"	L172108721		1 x Pal	13 Neto

Worktops / Encimeras / Tablettes

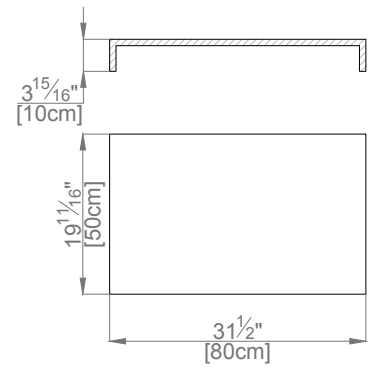

Bathrooms

Wood Top 80



The set includes / *El conjunto incluye /*
L'ensemble comprend les éléments suivants:

- Countertop / *Encimera / Tablettes*
- Bracket / *Escuadra de sujeción / Équerre de fixation*
- Screws / *Tornillería / Visserie*

Description	Format	Codes	Group	Pcs	Kg
Nogal Intense	80x50x10cm	100114120	G-176	1 x Cj	10 x Cj
	31 1/2"x19 11/16"x3 15/16"	L172108781		1 x Pal	9 Neto
Nogal Warm	80x50x10cm	100114123	G-176	1 x Cj	10 x Cj
	31 1/2"x19 11/16"x3 15/16"	L172108811		1 x Pal	9 Neto

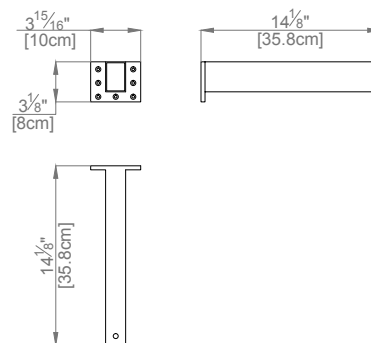
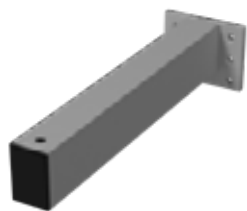

Wall Coverings Faces S3 Negro, Faces S4 Negro / Complementary Products Faces Grey Stone, Wood Top Nogal Intense

**Soporte Encimera Recto**

35,8x8x10cm - 14 1/8"x3 1/8"x3 15/16"

100125549 - L109002091 - G-165

Pcs	Kg
1 x Cj	2 x Cj
240 x Pal	1,5 Neto

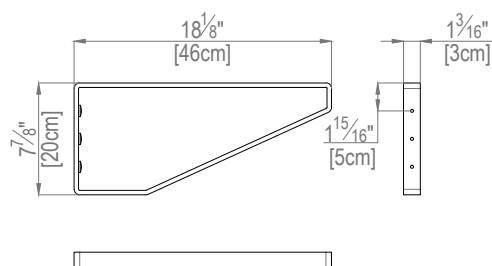
**Soporte Encimera con Forma**

46x20cm - 18 1/8"x7 7/8"

100153032 - L179702506 - G-165

Pcs	Kg
1 x Cj	3 x Cj
160 x Pal	2,2 Neto

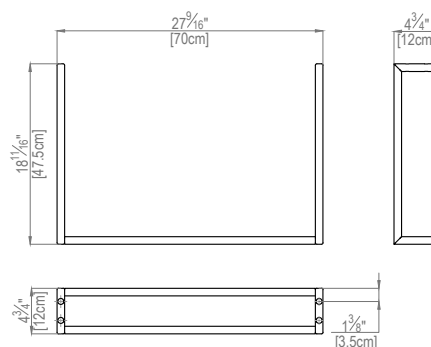
**Soporte Encimera 70x47,5cm**

70x47,5cm - 27 9/16"x18 11/16"

100151936 - L179702489 - G-173

Pcs	Kg
1 x Cj	5 x Cj
20 x Pal	4,2 Neto

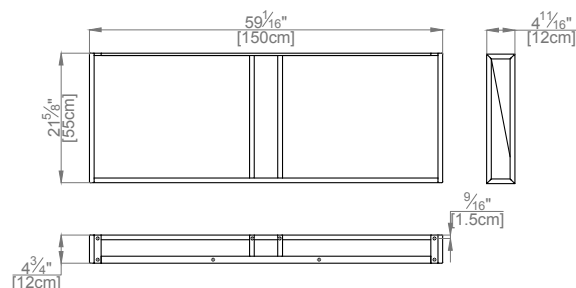
**Soporte Encimera 150x55cm**

150x55cm - 59"x21 5/8"

100059780 - L179702040 - G-165

Pcs	Kg
1 x Cj	8 x Cj
5x Pal	7,5 Neto

Worktops / Encimeras / Tablettes

Examples of custom worktops / *Ejemplos de encimeras a medida / Exemples de tablettes personnalisés*

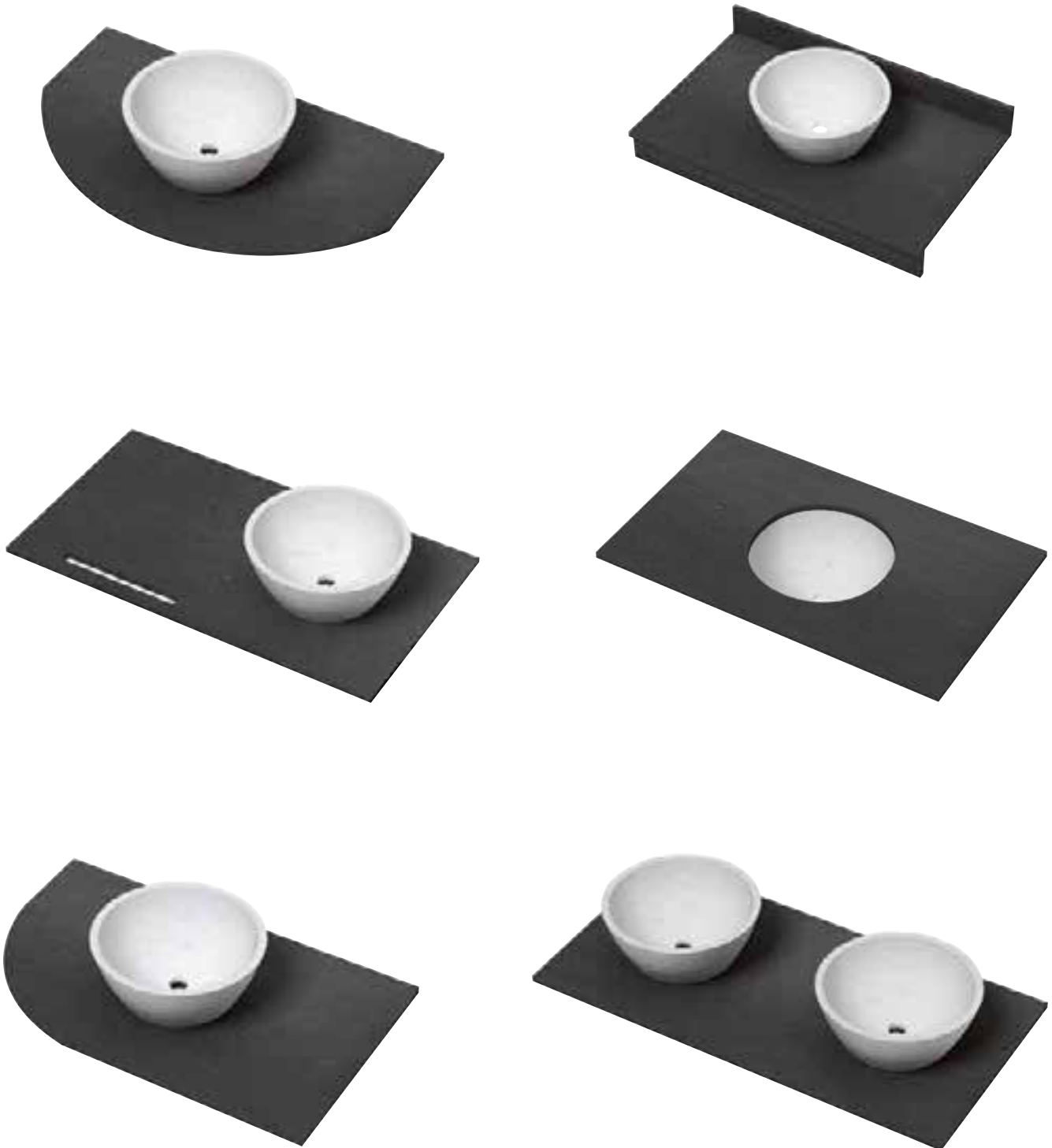

*Special countertops do not include brackets / *Las encimeras especiales no incluyen soportes / Les tablettes spéciales sont fournies sans supports*



Furniture Muebles Meubles

—

Hamptom
Boston
W-Tower



02

Furniture / Muebles / Meubles

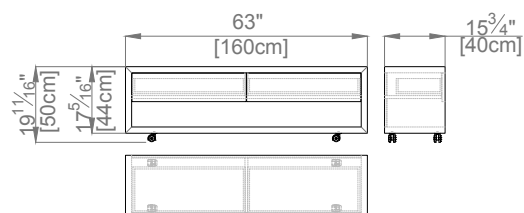

Hampton



The set includes / El conjunto incluye /
L'ensemble comprend les éléments suivants:

-Furniture / Mueble / Meuble
-Screws / Tornillería / Visserie
-Wheels / Ruedas / Roues

Description	Format	Codes	Group	Pcs	Kg
Nogal Intense	160x44x40cm 63"x17 3/8"x15 3/4"	100081288 L175000012	G-184	1 x Cj 4 x Pal	72,45 x Cj 289,80 x Pal
Nogal Warm	160x44x40cm 63"x17 3/8"x15 3/4"	100081289 L175000004	G-184	1 x Cj 4 x Pal	72,45 x Cj 289,80 x Pal

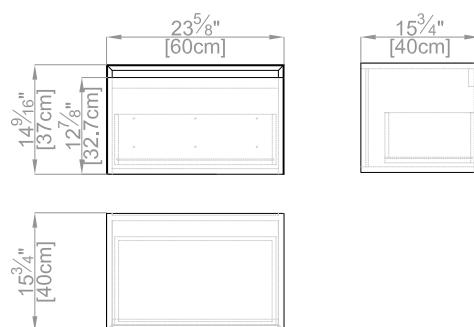

W-Tower



The set includes / El conjunto incluye /
L'ensemble comprend les éléments suivants:

-Furniture / Mueble / Meuble
-Screws / Tornillería / Visserie

Description	Format	Codes	Group	Pcs	Kg
Nogal Intense	60x37x40cm 23 5/8"x14 9/16"x15 3/4"	100155860 L179702584	G-178	1 x Cj 1 x Pal	19,15 x Cj 18,50 Neto
Roble Sunset	60x37x40cm 23 5/8"x14 9/16"x15 3/4"	100155875 L179702569	G-178	1 x Cj 1 x Pal	19,15 x Cj 18,50 Neto
Nogal Warm	60x37x40cm 23 5/8"x14 9/16"x15 3/4"	100155865 L179702572	G-178	1 x Cj 1 x Pal	19,15 x Cj 18,50 Neto
Roble Cloudy	60x37x40cm 23 5/8"x14 9/16"x15 3/4"	100155870 L179702576	G-178	1 x Cj 1 x Pal	19,15 x Cj 18,50 Neto

Furniture / Muebles / Meubles

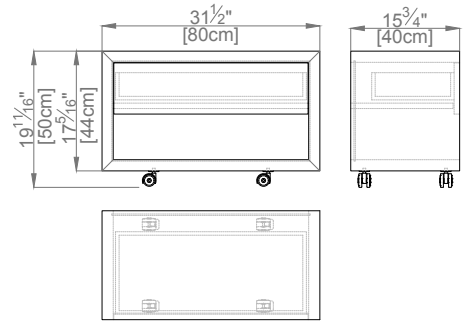

Bathrooms

Boston



The set includes / *El conjunto incluye* /
L'ensemble comprend les éléments suivants:

- Furniture / *Mueble* / *Meuble*
- Screws / *Tornillería* / *Visserie*
- Wheels / *Ruedas* / *Roues*

Description	Format	Codes	Group	Pcs	Kg
Nogal Intense	80x44x40cm	100153000	G-181	1 x Cj	38,81 x Cj
	31 1/2"x17 3/8"x15 3/4"	L175000084		1 x Pal	38,81 x Pal
Nogal Warm	80x44x40cm	100153001	G-181	1 x Cj	38,81 x Cj
	31 1/2"x17 3/8"x15 3/4"	L175000081		1 x Pal	38,81 x Pal



Floor Coverings Linkfloor Hotel Air Silver / Wall Coverings Javea Seagreen / Complementary Products Boston Nogal Warm, Basic Persian White





Complete
Sets
Conjuntos
Completo
Esembles
Complets
—

02 Complete Sets / Conjuntos Completos / Ensembles Complets

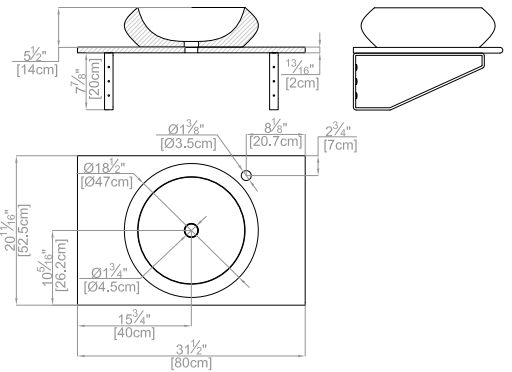

Lavabo + Encimera Crema Italia



The set includes / El conjunto incluye / L'ensemble comprend les éléments suivants:

- Wash basin / Lavabo / Lavabo
- Countertop / Encimera / Tablette
- Bracket / Escuadra de sujeción / Équerre de fixation
- Screws / Tornillería / Visserie

Description	Format	Codes	Group	Pcs	Kg
Lavabo+Encimera Cr. Italia	-	100151804 L179702484	G-181	-	64 x Cj 58,5 Neto

Qmax L/min=12 l/min (Pressure/Presión/Pression= 3 bar)



VACIADOR FIJO TAPA PIEDRA COMPATIBLE USA
Included / Incluido / Inclus



Compatible with / Compatible con / Compatible avec:



USA SIFÓN PROJECT N
100209767 - N194710597
NOKEN

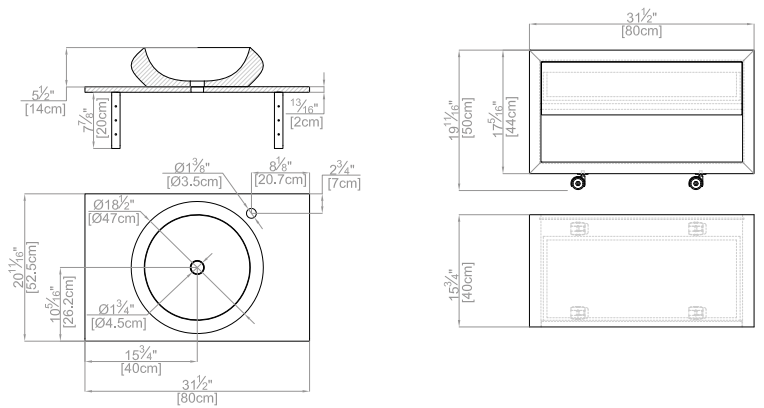

Lavabo + Encimera + Boston



The set includes / El conjunto incluye / L'ensemble comprend les éléments suivants:

- Wash basin / Lavabo / Lavabo
- Countertop / Encimera / Tablette
- Bracket / Escuadra de sujeción / Équerre de fixation
- Screws / Tornillería / Visserie
- Furniture / Mueble / Meuble

Description	Format	Codes	Group	Pcs	Kg
Lavabo+Encimera+Boston Nogal Intense	-	100153725 L170302865	G-184	-	102.81 x Cj 97,50 Neto
Lavabo+Encimera+Boston Nogal Warm	-	100153726 L170302864	G-184	-	102.81 x Cj 97,50 Neto

Qmax L/min=12 l/min (Pressure/Presión/Pression= 3 bar)



VACIADOR FIJO TAPA PIEDRA COMPATIBLE USA
Included / Incluido / Inclus



Compatible with / Compatible con / Compatible avec:



USA SIFÓN PROJECT N
100209767 - N194710597
NOKEN



Complete Sets / Conjuntos Completos / Ensembles Complets

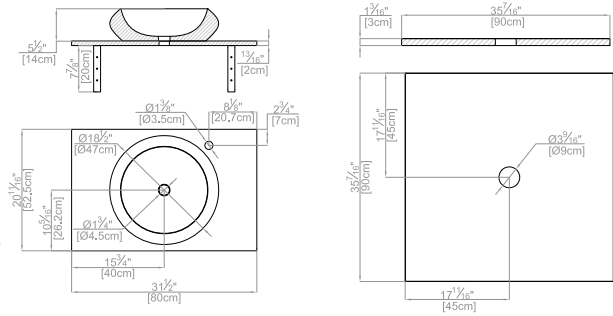
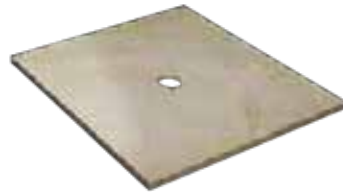

Lavabo + Encimera + P.ducha 90 Cr. Italia



The set includes / El conjunto incluye / L'ensemble comprend les éléments suivants:

- Wash basin / Lavabo / Lavabo
- Countertop / Encimera / Tablettes
- Bracket / Escuadra de sujeción / Équerre de fixation
- Screws / Tornillería / Visserie
- Shower tray / Plato de ducha / Receveur de douche
- Shower tray drain kit / Kit desagüe plato de ducha / Kit bonde pour receveur de douche

Description	Format	Codes	Group	Pcs	Kg
Lavabo+Encimera+P.ducha 90 Cr. Italia	-	100151803 L179702486	G-184	-	223,81 x Cj 167,50 Neto

Qmax L/min=12 l/min (Pressure/Presión/Pression= 3 bar)



VACIADOR FIJO LAVABO TAPA PIEDRA COMPATIBLE USA



Included / Incluido / Inclus

Compatible with / Compatible con / Compatible avec:



USA SIFÓN PROJECT N
100209767 - N194710597
NOKEN

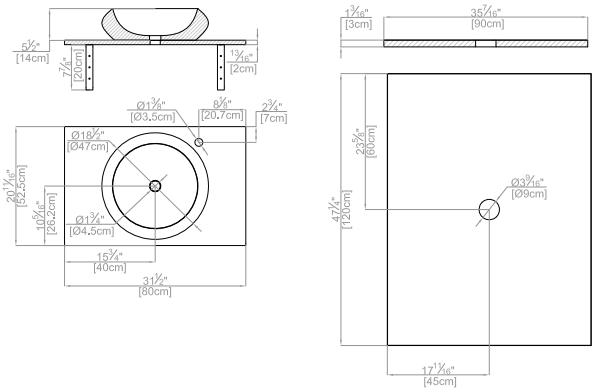

Lavabo + Encimera + P.ducha 120 Cr. Italia



The set includes / El conjunto incluye / L'ensemble comprend les éléments suivants:

- Wash basin / Lavabo / Lavabo
- Countertop / Encimera / Tablettes
- Bracket / Escuadra de sujeción / Équerre de fixation
- Screws / Tornillería / Visserie
- Shower tray / Plato de ducha / Receveur de douche
- Shower tray drain kit / Kit desagüe plato de ducha / Kit bonde pour receveur de douche

Description	Format	Codes	Group	Pcs	Kg
Lavabo+Encimera+P.ducha 120 Cr. Italia	-	100151802 L179702485	G-184	-	244,81 x Cj 189,50 Neto

Qmax L/min=12 l/min (Pressure/Presión/Pression= 3 bar)



VACIADOR FIJO LAVABO TAPA PIEDRA COMPATIBLE USA



Included / Incluido / Inclus

Compatible with / Compatible con / Compatible avec:



USA SIFÓN PROJECT N
100209767 - N194710597
NOKEN





Karon

—
by L'Antic Colonial

Floor Coverings Moka Classico / Wall Coverings Colors Alumium Olive /
Complementary Products Karon Oval Crema Italia, Wood Top Nogal Warm

02

Karon

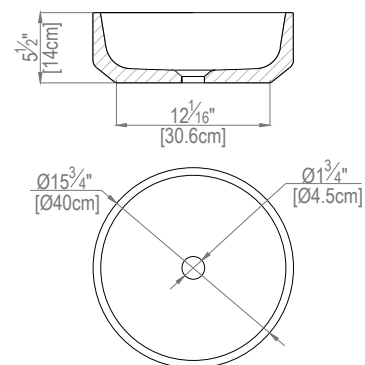

Karon Circle



MATT

WASHBASIN ON
SUPPORT

BIOPROT

The set includes / *El conjunto incluye /*
L'ensemble comprend les éléments suivants:-Wash basin / *Lavabo / Lavabo*

Description	Format	Codes	Group	Pcs	Kg
Crema Italia Classico	40x40x14 cm 15 3/4"x15 3/4"x5 1/2"	100203158 L179703356	G-179	1 x Cj 6 x Pal	23 x Cj 138 x Pal
Grey Stone Classico	40x40x14 cm 15 3/4"x15 3/4"x5 1/2"	100203165 L179703391	G-179	1 x Cj 6 x Pal	23 x Cj 138 x Pal
Habana Dark Classico	40x40x14 cm 15 3/4"x15 3/4"x5 1/2"	100203175 L179703387	G-179	1 x Cj 6 x Pal	23 x Cj 138 x Pal
Persian White Classico	40x40x14 cm 15 3/4"x15 3/4"x5 1/2"	100203166 L179703383	G-179	1 x Cj 6 x Pal	23 x Cj 138 x Pal

Qmax L/min=12 l/min (Pressure/Presión/Pression= 3 bar)

NEW

**VACIADOR FIJO TAPA
PIEDRA COMPATIBLE USA**

Included / Includo / Inclus

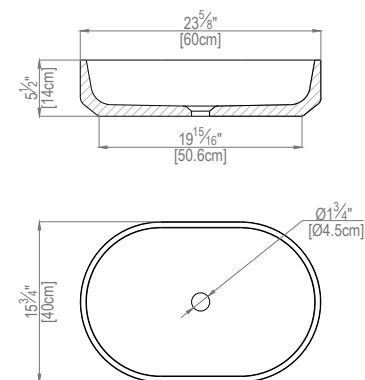
Compatible with / *Compatible con / Compatible avec:***USA SIFÓN PROJECT N**
100209767 - N194710597
NOKEN

Karon Oval



MATT

WASHBASIN ON
SUPPORT

BIOPROT

The set includes / *El conjunto incluye /*
L'ensemble comprend les éléments suivants:-Wash basin / *Lavabo / Lavabo*

Description	Format	Codes	Group	Pcs	Kg
Crema Italia Classico	60x40x14 cm 23 5/8"x15 3/4"x5 1/2"	100203169 L179703389	G-186	1 x Cj 1 x Pal	30 x Cj 30 x Pal
Grey Stone Classico	60x40x14 cm 23 5/8"x15 3/4"x5 1/2"	100203202 L179703399	G-186	1 x Cj 1 x Pal	30 x Cj 30 x Pal
Habana Dark Classico	60x40x14 cm 23 5/8"x15 3/4"x5 1/2"	100203184 L179703382	G-186	1 x Cj 1 x Pal	30 x Cj 30 x Pal
Persian White Classico	60x40x14 cm 23 5/8"x15 3/4"x5 1/2"	100203185 L179703394	G-186	1 x Cj 1 x Pal	30 x Cj 30 x Pal

Qmax L/min=12 l/min (Pressure/Presión/Pression= 3 bar)

NEW

**VACIADOR FIJO TAPA
PIEDRA COMPATIBLE USA**

Included / Includo / Inclus

Compatible with / *Compatible con / Compatible avec:***USA SIFÓN PROJECT N**
100209767 - N194710597
NOKEN

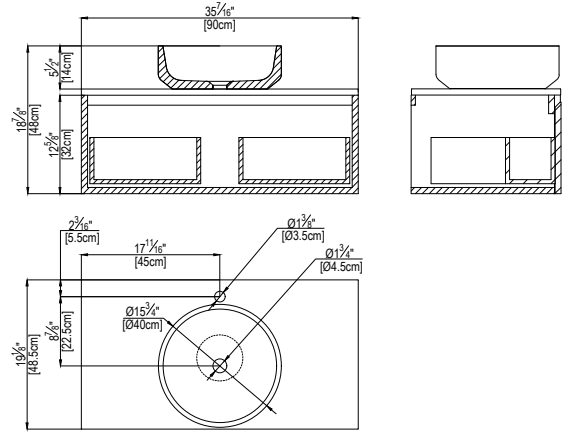

Conjunto Karon Circle



The set includes / El conjunto incluye / L'ensemble comprend les éléments suivants:

- Wash basin / Lavabo / Lavabo
- Stone Countertop / Encimera de Piedra / Plan de Toilette en pierre
- Furniture / Mueble / Meuble
- Screws / Tornilleria / Visserie

Description	Format	Codes	Group	Pcs	Kg
Crema Italia / Nogal Intense	90x48,5x48 cm 35 7/16"x19 1/8"x18 7/8"	100203136 L179703368	G-188	1 x Cj 1 x Pal	59 x Cj 59 x Pal
Crema Italia / Nogal Warm	90x48,5x48 cm 35 7/16"x19 1/8"x18 7/8"	100203142 L179703360	G-188	1 x Cj 1 x Pal	59 x Cj 59 x Pal
Grey Stone / Nogal Intense	90x48,5x48 cm 35 7/16"x19 1/8"x18 7/8"	100203134 L179703354	G-188	1 x Cj 1 x Pal	59 x Cj 59 x Pal
Grey Stone / Nogal Warm	90x48,5x48 cm 35 7/16"x19 1/8"x18 7/8"	100203135 L179703358	G-188	1 x Cj 1 x Pal	59 x Cj 59 x Pal
Habana Dark / Nogal Intense	90x48,5x48 cm 35 7/16"x19 1/8"x18 7/8"	100203133 L179703364	G-188	1 x Cj 1 x Pal	59 x Cj 59 x Pal
Habana Dark / Nogal Warm	90x48,5x48 cm 35 7/16"x19 1/8"x18 7/8"	100203151 L179703359	G-188	1 x Cj 1 x Pal	59 x Cj 59 x Pal
Persian White / Nogal Intense	90x48,5x48 cm 35 7/16"x19 1/8"x18 7/8"	100203137 L179703369	G-188	1 x Cj 1 x Pal	59 x Cj 59 x Pal
Persian White / Nogal Warm	90x48,5x48 cm 35 7/16"x19 1/8"x18 7/8"	100203161 L179703361	G-188	1 x Cj 1 x Pal	59 x Cj 59 x Pal



Compatible with / Compatible con / Compatible avec:



Qmax L/min=12 l/min (Pressure/Presión/Pression= 3 bar)

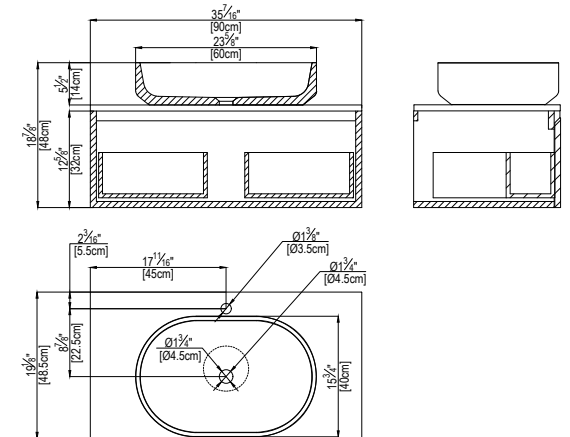

Conjunto Karon Oval



The set includes / El conjunto incluye / L'ensemble comprend les éléments suivants:

- Wash basin / Lavabo / Lavabo
- Stone Countertop / Encimera de Piedra / Plan de Toilette en pierre
- Furniture / Mueble / Meuble
- Screws / Tornilleria / Visserie

Description	Format	Codes	Group	Pcs	Kg
Crema Italia / Nogal Intense	90x48,5x48 cm 35 7/16"x19 1/8"x18 7/8"	100203152 L179703371	G-192	1 x Cj 1 x Pal	68 x Cj 68 x Pal
Crema Italia / Nogal Warm	90x48,5x48 cm 35 7/16"x19 1/8"x18 7/8"	100203171 L179703398	G-192	1 x Cj 1 x Pal	68 x Cj 68 x Pal
Grey Stone / Nogal Intense	90x48,5x48 cm 35 7/16"x19 1/8"x18 7/8"	100203139 L179703350	G-192	1 x Cj 1 x Pal	68 x Cj 68 x Pal
Grey Stone / Nogal Warm	90x48,5x48 cm 35 7/16"x19 1/8"x18 7/8"	100203170 L179703380	G-192	1 x Cj 1 x Pal	68 x Cj 68 x Pal
Habana Dark / Nogal Intense	90x48,5x48 cm 35 7/16"x19 1/8"x18 7/8"	100203143 L179703351	G-192	1 x Cj 1 x Pal	68 x Cj 68 x Pal
Habana Dark / Nogal Warm	90x48,5x48 cm 35 7/16"x19 1/8"x18 7/8"	100203138 L179703370	G-192	1 x Cj 1 x Pal	68 x Cj 68 x Pal
Persian White / Nogal Intense	90x48,5x48 cm 35 7/16"x19 1/8"x18 7/8"	100203153 L179703365	G-192	1 x Cj 1 x Pal	68 x Cj 68 x Pal
Persian White / Nogal Warm	90x48,5x48 cm 35 7/16"x19 1/8"x18 7/8"	100203154 L179703375	G-192	1 x Cj 1 x Pal	68 x Cj 68 x Pal



Compatible with / Compatible con / Compatible avec:



Qmax L/min=12 l/min (Pressure/Presión/Pression= 3 bar)

Karon

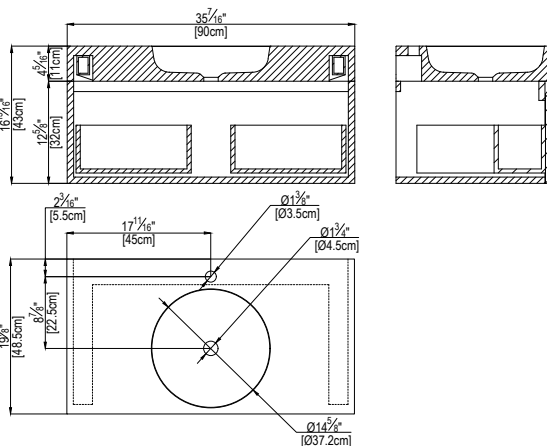

Karon Circle Countertop Tower 90



The set includes / El conjunto incluye / L'ensemble comprend les éléments suivants:

- Wash basin / Lavabo / Lavabo
- Bracket / Escuadra de sujeción / Équerre de fixation
- Furniture / Mueble / Meuble
- Screws / Tornillería / Visserie

Description	Format	Codes	Group	Pcs	Kg
Crema Italia / Nogal Intense	90x48,5x43 cm 35 7/16"x19 1/8"x16 15/16"	100203157 L179703362	G-190	1 x Cj 1 x Pal	114 x Cj 114 x Pal
Crema Italia / Nogal Warm	90x48,5x43 cm 35 7/16"x19 1/8"x16 15/16"	100203164 L179703385	G-190	1 x Cj 1 x Pal	114 x Cj 114 x Pal
Grey Stone / Nogal Intense	90x48,5x43 cm 35 7/16"x19 1/8"x16 15/16"	100203163 L179703352	G-190	1 x Cj 1 x Pal	114 x Cj 114 x Pal
Grey Stone / Nogal Warm	90x48,5x43 cm 35 7/16"x19 1/8"x16 15/16"	100203146 L179703353	G-190	1 x Cj 1 x Pal	114 x Cj 114 x Pal
Habana Dark / Nogal Intense	90x48,5x43 cm 35 7/16"x19 1/8"x16 15/16"	100203144 L179703367	G-190	1 x Cj 1 x Pal	114 x Cj 114 x Pal
Habana Dark / Nogal Warm	90x48,5x43 cm 35 7/16"x19 1/8"x16 15/16"	100203145 L179703363	G-190	1 x Cj 1 x Pal	114 x Cj 114 x Pal
Persian White / Nogal Intense	90x48,5x43 cm 35 7/16"x19 1/8"x16 15/16"	100203174 L179703381	G-190	1 x Cj 1 x Pal	114 x Cj 114 x Pal
Persian White / Nogal Warm	90x48,5x43 cm 35 7/16"x19 1/8"x16 15/16"	100203147 L179703374	G-190	1 x Cj 1 x Pal	114 x Cj 114 x Pal

Qmax L/min=12 l/min (Pressure/Presión/Pression= 3 bar)

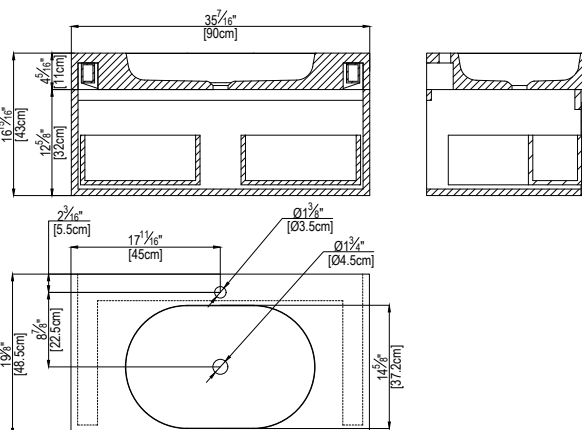

Karon Oval Countertop Tower 90



The set includes / El conjunto incluye / L'ensemble comprend les éléments suivants:

- Wash basin / Lavabo / Lavabo
- Stone Countertop / Encimera de Piedra / Plan de Toilete en pierre
- Furniture / Mueble / Meuble
- Screws / Tornillería / Visserie

Description	Format	Codes	Group	Pcs	Kg
Crema Italia / Nogal Intense	90x48,5x43 cm 35 7/16"x19 1/8"x16 15/16"	100203182 L179703395	G-190	1 x Cj 1 x Pal	103 x Cj 103 x Pal
Crema Italia / Nogal Warm	90x48,5x43 cm 35 7/16"x19 1/8"x16 15/16"	100203200 L179703377	G-190	1 x Cj 1 x Pal	103 x Cj 103 x Pal
Grey Stone / Nogal Intense	90x48,5x43 cm 35 7/16"x19 1/8"x16 15/16"	100203179 L179703376	G-190	1 x Cj 1 x Pal	103 x Cj 103 x Pal
Grey Stone / Nogal Warm	90x48,5x43 cm 35 7/16"x19 1/8"x16 15/16"	100203190 L179703392	G-190	1 x Cj 1 x Pal	103 x Cj 103 x Pal
Habana Dark / Nogal Intense	90x48,5x43 cm 35 7/16"x19 1/8"x16 15/16"	100203149 L179703366	G-190	1 x Cj 1 x Pal	103 x Cj 103 x Pal
Habana Dark / Nogal Warm	90x48,5x43 cm 35 7/16"x19 1/8"x16 15/16"	100203181 L179703378	G-190	1 x Cj 1 x Pal	103 x Cj 103 x Pal
Persian White / Nogal Intense	90x48,5x43 cm 35 7/16"x19 1/8"x16 15/16"	100203201 L179703388	G-190	1 x Cj 1 x Pal	103 x Cj 103 x Pal
Persian White / Nogal Warm	90x48,5x43 cm 35 7/16"x19 1/8"x16 15/16"	100203183 L179703393	G-190	1 x Cj 1 x Pal	103 x Cj 103 x Pal

Qmax L/min=12 l/min (Pressure/Presión/Pression= 3 bar)



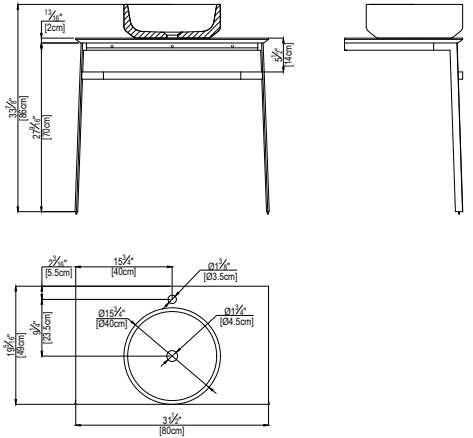

Conjunto Karon
Circle Structure



The set includes / El conjunto incluye /
L'ensemble comprend les éléments suivants:

- Wash basin / Lavabo / Lavabo
- Stone Countertop / Encimera de Piedra / Plan de Toilette en pierre
- Metal Structure / Estructura Metal / Structure Métallique
- Screws / Tornillería / Visserie

Description	Format	Codes	Group	Pcs	Kg
Crema Italia Classico	80x49x86 cm 31 1/2"x19 6/16"x33 7/8"	100203132 L179703348	G-187	1 x Cj 1 x Pal	48 x Cj 48 x Pal
Grey Stone Classico	80x49x86 cm 31 1/2"x19 6/16"x33 7/8"	100203141 L179703373	G-187	1 x Cj 1 x Pal	48 x Cj 48 x Pal
Habana Dark Classico	80x49x86 cm 31 1/2"x19 6/16"x33 7/8"	100203109 L179703347	G-187	1 x Cj 1 x Pal	48 x Cj 48 x Pal
Persian White Classico	80x49x86 cm 31 1/2"x19 6/16"x33 7/8"	100203160 L179703357	G-187	1 x Cj 1 x Pal	48 x Cj 48 x Pal

Qmax L/min=12 l/min (Pressure/Presión/Pression= 3 bar)

NEW



VACIADOR FIJO TAPA
PIEDRA COMPATIBLE USA

Included / Incluido / Inclus



Compatible with / Compatible con / Compatible avec:



USA SIFÓN PROJECT N
100209767 - N194710597
NOKEN

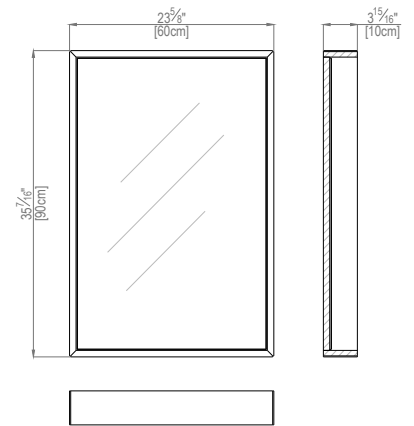

Tower Mirror



The set includes / El conjunto incluye /
L'ensemble comprend les éléments suivants:

- Mirror / Espejo / Miroir
- Screws / Tornillería / Visserie

Description	Format	Codes	Group	Pcs	Kg
Nogal Intense	60x90x10 cm 23 5/8"x35 7/16"x3 15/16"	100203283 L179703390	G-175	1 x Cj 1 x Pal	20 x Cj 20 x Pal
Nogal Warm	60x90x10 cm 23 5/8"x35 7/16"x3 15/16"	100203284 L179703396	G-175	1 x Cj 1 x Pal	20 x Cj 20 x Pal

NEW



Menhir

by EstudiHac

Complementary Products Men{H}ir Crema Italia, Men{H}ir Encimera S Roble Antracita, Men{H}ir Mueble S Crema Italia-Roble Antracita, Men{H}ir Espejo Roble Antracita, Men{H}ir Estante Vertical I Roble Antracita, Men{h}ir Bañera Crema Italia Roble Antracita



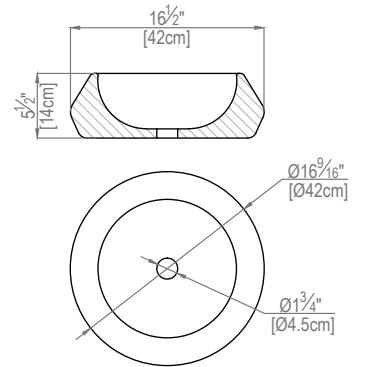

Men{H}ir



The set includes / El conjunto incluye / L'ensemble comprend les éléments suivants:

-Wash basin / Lavabo / Lavabo

Description	Format	Codes	Group	Pcs	Kg
Persian White Classico	42x42x14cm 16 9/16"x16 9/16"x5 1/2"	100177137 L179702893	G-178	1 x Cj 6 x Pal	31 x Cj 27 Neto
Crema Italia Classico	42x42x14cm 16 9/16"x16 9/16"x5 1/2"	100120627 L170302838	G-178	1 x Cj 6 x Pal	31 x Cj 27 Neto
Habana Dark Classico	42x42x14cm 16 9/16"x16 9/16"x5 1/2"	100161292 L179702679	G-178	1 x Cj 6 x Pal	31 x Cj 27 Neto

• STOCK



VACIADOR FIJO TAPA PIEDRA COMPATIBLE USA
Included / Incluido / Inclus



Compatible with / Compatible con / Compatible avec:



USA SIFÓN PROJECT N
100209767 - N194710597
NOKEN



Qmax L/min=12 l/min (Pressure/Presión/Pression= 3 bar)

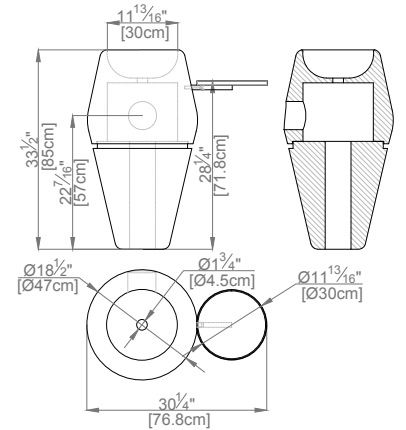

Men{H}ir Stand



The set includes / El conjunto incluye / L'ensemble comprend les éléments suivants:

-Wash basin / Lavabo / Lavabo

-Shelf / Estante / Etagère

-Maintenance kit / Kit de mantenimiento / Kit d'entretien

Description	Format	Codes	Group	Pcs	Kg
Persian White / Roble Antracita	76,8x47x85cm 30 1/4"x18 1/2"x33 1/2"	100177301 L179702926	G-190	1 x Cj 1 x Pal	195 x Cj 132 Neto
Persian White / Roble Natural	76,8x47x85cm 30 1/4"x18 1/2"x33 1/2"	100177284 L179702913	G-190	1 x Cj 1 x Pal	195 x Cj 132 Neto
Persian White / Nogal Americano	76,8x47x85cm 30 1/4"x18 1/2"x33 1/2"	100177300 L179702930	G-190	1 x Cj 1 x Pal	195 x Cj 132 Neto
Crema Italia / Roble Antracita	76,8x47x85cm 30 1/4"x18 1/2"x33 1/2"	100121770 L179702179	G-190	1 x Cj 1 x Pal	195 x Cj 132 Neto
Crema Italia / Roble Natural	76,8x47x85cm 30 1/4"x18 1/2"x33 1/2"	100120654 L179702160	G-190	1 x Cj 1 x Pal	195 x Cj 132 Neto
Crema Italia / Nogal Americano	76,8x47x85cm 30 1/4"x18 1/2"x33 1/2"	100161299 L179702678	G-190	1 x Cj 1 x Pal	195 x Cj 132 Neto
Habana Dark / Roble Antracita	76,8x47x85cm 30 1/4"x18 1/2"x33 1/2"	100161308 L179702684	G-190	1 x Cj 1 x Pal	195 x Cj 132 Neto
Habana Dark / Roble Natural	76,8x47x85cm 30 1/4"x18 1/2"x33 1/2"	100161308 L179702684	G-190	1 x Cj 1 x Pal	195 x Cj 132 Neto
Habana Dark / Nogal Americano	76,8x47x85cm 30 1/4"x18 1/2"x33 1/2"	100161314 L179702688	G-190	1 x Cj 1 x Pal	195 x Cj 132 Neto



VACIADOR FIJO TAPA PIEDRA COMPATIBLE USA
Included / Incluido / Inclus



Compatible with / Compatible con / Compatible avec:



USA SIFÓN PROJECT N
100209767 - N194710597
NOKEN



Qmax L/min=12 l/min (Pressure/Presión/Pression= 3 bar)

Menhir

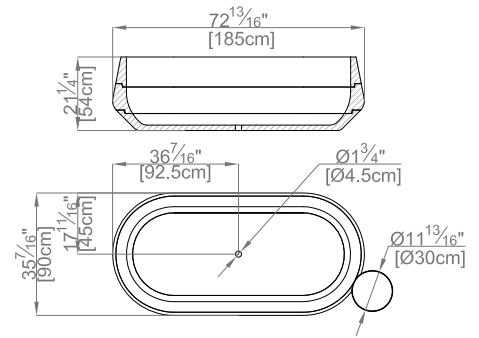

Men{H}ir Bañera



The set includes / El conjunto incluye / L'ensemble comprend les éléments suivants:

- Bathtub / Bañera / Baignoires
- Installation kit / Kit de instalación / Kit d'installation
- Shelf / Estante / Étagère
- Gasket / Junta de montaje / Joint de montage
- Maintenance kit / Kit de mantenimiento / Kit d'entretien

Description	Format	Codes	Group	Pcs	Kg
Persian White / Roble Antracita	185x90x54cm 72 13/16"x35 7/16"x21 1/4"	100177297 L179702904	G-199	1 x Cj 1 x Pal	775 x Cj 575 Neto
Persian White / Roble Natural	185x90x54cm 72 13/16"x35 7/16"x21 1/4"	100177314 L179702908	G-199	1 x Cj 1 x Pal	775 x Cj 575 Neto
Persian White / Nogal Americano	185x90x54cm 72 13/16"x35 7/16"x21 1/4"	100177287 L179702909	G-199	1 x Cj 1 x Pal	775 x Cj 575 Neto
Crema Italia / Roble Antracita	185x90x54cm 72 13/16"x35 7/16"x21 1/4"	100147973 L179702451	G-199	1 x Cj 1 x Pal	775 x Cj 575 Neto
Crema Italia / Roble Natural	185x90x54cm 72 13/16"x35 7/16"x21 1/4"	100146457 L179702448	G-199	1 x Cj 1 x Pal	775 x Cj 575 Neto
Crema Italia / Nogal Americano	185x90x54cm 72 13/16"x35 7/16"x21 1/4"	100161281 L179702658	G-199	1 x Cj 1 x Pal	775 x Cj 575 Neto
Habana Dark / Roble Antracita	185x90x54cm 72 13/16"x35 7/16"x21 1/4"	100161280 L179702655	G-199	1 x Cj 1 x Pal	775 x Cj 575 Neto
Habana Dark / Roble Natural	185x90x54cm 72 13/16"x35 7/16"x21 1/4"	100161290 L179702656	G-199	1 x Cj 1 x Pal	775 x Cj 575 Neto
Habana Dark / Nogal Americano	185x90x54cm 72 13/16"x35 7/16"x21 1/4"	100161291 L179702657	G-199	1 x Cj 1 x Pal	775 x Cj 575 Neto



VACIADOR PULSADOR CLIKER SIN REBOSADERO
100110743 - N698350001
NOKEN



STONE WASTE COVER EMBELLECEDOR PIEDRA ÉLÉMENT DÉCORATIF PIERRE
Hidden-drain pedestals are available on order in the same material and with the same finish as that used for the bathtubs. / Los embellecedores del desagüe pueden realizarse bajo pedido con el mismo material y acabado que la bañera. / Sur demande, les éléments décoratifs du drain peuvent être fabriqués dans le même matériel et avec les mêmes finitions que le baignoires. (See page / Ver página / Voir page 157)



02

Menhir

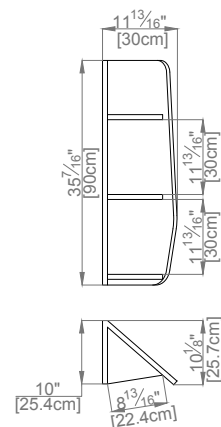

Men{H}ir Estante I



The set includes / *El conjunto incluye* /
L'ensemble comprend les éléments suivants:

-Shelf / *Estante* / *Etagère*
-Screws / *Tornillería* / *Visserie*

Description	Format	Codes	Group	Pcs	Kg
Roble Antracita	90x30x25,7cm 35 7/16"x11 13/16"x10 1/8"	100120599 L175000049	G-175	1 x Cj 4 x Pal	11 x Cj 7 Neto
Roble Natural	90x30x25,7cm 35 7/16"x11 13/16"x10 1/8"	100120640 L175000053	G-175	1 x Cj 4 x Pal	11 x Cj 7 Neto
Nogal Americano	90x30x25,7cm 35 7/16"x11 13/16"x10 1/8"	100161300 L179702694	G-175	1 x Cj 4 x Pal	11 x Cj 7 Neto

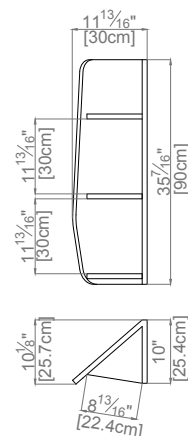

Men{H}ir Estante D



The set includes / *El conjunto incluye* /
L'ensemble comprend les éléments suivants:

-Shelf / *Estante* / *Etagère*
-Screws / *Tornillería* / *Visserie*

Description	Format	Codes	Group	Pcs	Kg
Roble Antracita	90x30x25,7cm 35 7/16"x11 13/16"x10 1/8"	100120598 L175000048	G-175	1 x Cj 4 x Pal	11 x Cj 7 Neto
Roble Natural	90x30x25,7cm 35 7/16"x11 13/16"x10 1/8"	100120639 L175000055	G-175	1 x Cj 4 x Pal	11 x Cj 7 Neto
Nogal Americano	90x30x25,7cm 35 7/16"x11 13/16"x10 1/8"	100161283 L179702690	G-175	1 x Cj 4 x Pal	11 x Cj 7 Neto

Menhir

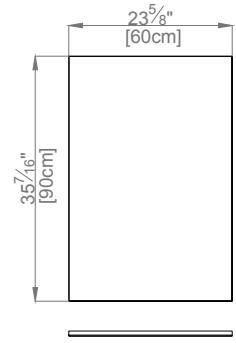

Bathrooms

Men{H}ir Espejo



MATT

The set includes / El conjunto incluye /
L'ensemble comprend les éléments suivants:

-Mirror / Espejo / Miroir
-Screws / Tornillería / Visserie

Description	Format	Codes	Group	Pcs	Kg
Roble Antracita	90x60cm	100153025	G-173	1 x Cj	9,70 x Cj
	35 7/16"x23 5/8"	L175000082		10 x Pal	5,70 Neto
Roble Natural	90x30x25,7cm	100153019	G-173	1 x Cj	9,70 x Cj
	35 7/16"x11 13/16"x10 1/8"	L175000083		10 x Pal	5,70 Neto
Nogal Americano	90x60cm	100161277	G-173	1 x Cj	9,70 x Cj
	35 7/16"x23 5/8"	L179702674		10 x Pal	5,70 Neto

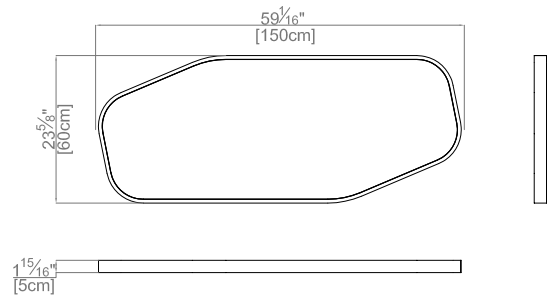

Men{H}ir Espejo L



MATT

The set includes / El conjunto incluye /
L'ensemble comprend les éléments suivants:

-Mirror / Espejo / Miroir
-Screws / Tornillería / Visserie

Description	Format	Codes	Group	Pcs	Kg
Roble Antracita	150x60x5cm	100146458	G-175	1 x Cj	31,50 x Cj
	59 1/16"x23 5/8"x1 15/16"	L175000070		1 x Pal	26,50 Neto
Roble Natural	150x60x5cm	100146437	G-175	1 x Cj	31,50 x Cj
	59 1/16"x23 5/8"x1 15/16"	L175000069		1 x Pal	26,50 Neto
Nogal Americano	150x60x5cm	100161238	G-175	1 x Cj	31,50 x Cj
	59 1/16"x23 5/8"x1 15/16"	L179702714		1 x Pal	26,50 Neto

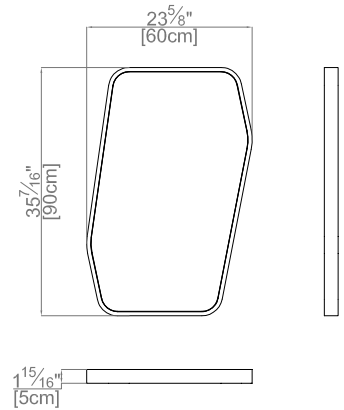

Men{H}ir Espejo S



MATT

The set includes / El conjunto incluye /
L'ensemble comprend les éléments suivants:

-MIRROR / Espejo / Miroir
-Screws / Tornillería / Visserie

Description	Format	Codes	Group	Pcs	Kg
Roble Antracita	60x90x5cm	100146438	G-173	1 x Cj	19 x Cj
	23 5/8"x35 7/16"x1 15/16"	L175000064		1 x Pal	14 Neto
Roble Natural	60x90x5cm	100146439	G-173	1 x Cj	19 x Cj
	23 5/8"x35 7/16"x1 15/16"	L175000071		1 x Pal	14 Neto
Nogal Americano	60x90x5cm	100161278	G-173	1 x Cj	19 x Cj
	23 5/8"x35 7/16"x1 15/16"	L179702713		1 x Pal	14 Neto

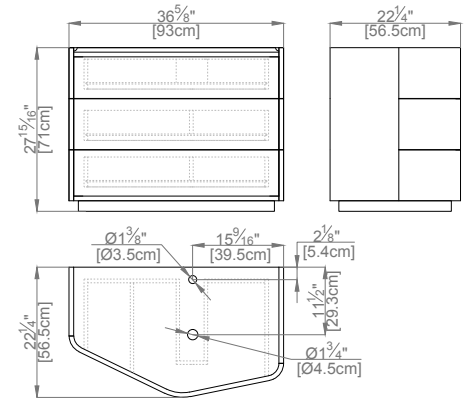

Men{H}ir Mueble S 3C



MATT

The set includes / El conjunto incluye /
L'ensemble comprend les éléments suivants:

-Furniture / Mueble / Meuble
-Screws / Tornillería / Visserie
-Stone countertop / Encimera de piedra / Plan de toilette en pierre

Description	Format	Codes	Group	Pcs	Kg
Persian White / Roble Antracita	94x56,5x71cm	100177293	G-192	1 x Cj	96 x Cj
	37"x22 1/4"x28"	L179702929		1 x Pal	61 Neto
Persian White / Roble Natural	94x56,5x71cm	100177275	G-192	1 x Cj	96 x Cj
	37"x22 1/4"x28"	L179702935		1 x Pal	61 Neto
Persian White / Nogal Americano	94x56,5x71cm	100177274	G-192	1 x Cj	96 x Cj
	37"x22 1/4"x28"	L179702927		1 x Pal	61 Neto
Crema Italia / Roble Antracita	94x56,5x71cm	100146534	G-192	1 x Cj	96 x Cj
	37"x22 1/4"x28"	L175000078		1 x Pal	61 Neto
Crema Italia / Roble Natural	94x56,5x71cm	100146504	G-192	1 x Cj	96 x Cj
	37"x22 1/4"x28"	L175000079		1 x Pal	61 Neto
Crema Italia / Nogal Americano	94x56,5x71cm	100161285	G-192	1 x Cj	96 x Cj
	37"x22 1/4"x28"	L179702663		1 x Pal	61 Neto
Habana Dark / Roble Antracita	94x56,5x71cm	100161294	G-192	1 x Cj	96 x Cj
	37"x22 1/4"x28"	L179702660		1 x Pal	61 Neto
Habana Dark / Roble Natural	94x56,5x71cm	100161284	G-192	1 x Cj	96 x Cj
	37"x22 1/4"x28"	L179702661		1 x Pal	61 Neto
Habana Dark / Nogal Americano	94x56,5x71cm	100161295	G-192	1 x Cj	96 x Cj
	37"x22 1/4"x28"	L179702662		1 x Pal	61 Neto

Menhir

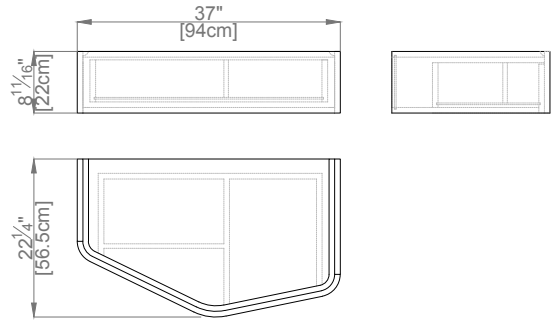

Bathrooms

Men{H}ir Mueble S



The set includes / El conjunto incluye /
L'ensemble comprend les éléments suivants:

- Furniture / Mueble / Meuble
- Screws / Tornillería / Visserie
- Stone countertop / Encimera de piedra / Plan de toilette en pierre

Description	Format	Codes	Group	Pcs	Kg
Persian White / Roble Antracita	94x56,5x22cm 37"x22 1/4"x8 5/8"	100177267 L179702915	G-184	1 x Cj 1 x Pal	71 x Cj 48 Neto
Persian White / Roble Natural	94x56,5x22cm 37"x22 1/4"x8 5/8"	100177268 L179702925	G-184	1 x Cj 1 x Pal	71 x Cj 48 Neto
Persian White / Nogal Americano	94x56,5x22cm 37"x22 1/4"x8 5/8"	100177269 L179702912	G-184	1 x Cj 1 x Pal	71 x Cj 48 Neto
Crema Italia / Roble Antracita	94x56,5x22cm 37"x22 1/4"x8 5/8"	100120648 L175000058	G-184	1 x Cj 1 x Pal	71 x Cj 48 Neto
Crema Italia / Roble Natural	94x56,5x22cm 37"x22 1/4"x8 5/8"	100120649 L175000057	G-184	1 x Cj 1 x Pal	71 x Cj 48 Neto
Crema Italia / Nogal Americano	94x56,5x22cm 37"x22 1/4"x8 5/8"	100161286 L179702669	G-184	1 x Cj 1 x Pal	71 x Cj 48 Neto
Habana Dark / Roble Antracita	94x56,5x22cm 37"x22 1/4"x8 5/8"	100161305 L179702665	G-184	1 x Cj 1 x Pal	71 x Cj 48 Neto
Habana Dark / Roble Natural	94x56,5x22cm 37"x22 1/4"x8 5/8"	100161312 L179702666	G-184	1 x Cj 1 x Pal	71 x Cj 48 Neto
Habana Dark / Nogal Americano	94x56,5x22cm 37"x22 1/4"x8 5/8"	100161306 L179702668	G-184	1 x Cj 1 x Pal	71 x Cj 48 Neto

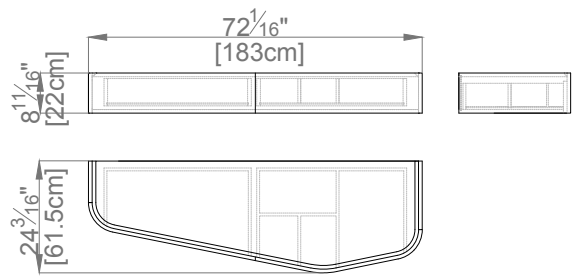

Men{H}ir Mueble L



The set includes / El conjunto incluye /
L'ensemble comprend les éléments suivants:

- Furniture / Mueble / Meuble
- Screws / Tornillería / Visserie
- Stone countertop / Encimera de piedra / Plan de toilette en pierre

Description	Format	Codes	Group	Pcs	Kg
Persian White / Roble Antracita	183x59,5x22cm 72 1/16"x23 7/16"x8 11/16"	100177273 L179702931	G-189	1 x Cj 1 x Pal	141 x Cj 90 Neto
Persian White / Roble Natural	183x59,5x22cm 72 1/16"x23 7/16"x8 11/16"	100177266 L179702933	G-189	1 x Cj 1 x Pal	141 x Cj 90 Neto
Persian White / Nogal Americano	183x59,5x22cm 72 1/16"x23 7/16"x8 11/16"	100177283 L179702918	G-189	1 x Cj 1 x Pal	141 x Cj 90 Neto
Crema Italia / Roble Antracita	183x59,5x22cm 72 1/16"x23 7/16"x8 11/16"	100120629 L175000050	G-189	1 x Cj 1 x Pal	141 x Cj 90 Neto
Crema Italia / Roble Natural	183x59,5x22cm 72 1/16"x23 7/16"x8 11/16"	100120647 L175000059	G-189	1 x Cj 1 x Pal	141 x Cj 90 Neto
Crema Italia / Nogal Americano	183x59,5x22cm 72 1/16"x23 7/16"x8 11/16"	100161311 L179702682	G-189	1 x Cj 1 x Pal	141 x Cj 90 Neto
Habana Dark / Roble Antracita	183x59,5x22cm 72 1/16"x23 7/16"x8 11/16"	100161310 L179702711	G-189	1 x Cj 1 x Pal	141 x Cj 90 Neto
Habana Dark / Roble Natural	183x59,5x22cm 72 1/16"x23 7/16"x8 11/16"	100161302 L179702677	G-189	1 x Cj 1 x Pal	141 x Cj 90 Neto
Habana Dark / Nogal Americano	183x59,5x22cm 72 1/16"x23 7/16"x8 11/16"	100161304 L179702706	G-189	1 x Cj 1 x Pal	141 x Cj 90 Neto

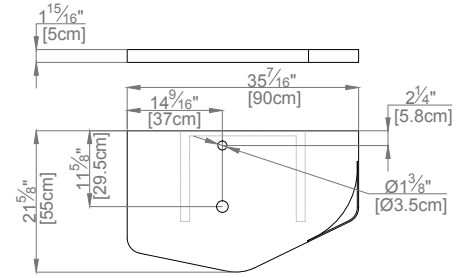

Men{H}ir Encimera S



MATT

The set includes / El conjunto incluye / L'ensemble comprend les éléments suivants:

- Countertop / Encimera / Tablettes
- Bracket / Escuadras de sujeción / Équerre de fixation
- Screws / Tornillería / Visserie

Description	Format	Codes	Group	Pcs	Kg
Roble Antracita	90x55x5cm 35 7/16"x21 5/8"x1 15/16"	100120628 L172109831	G-175	1 x Cj 5 x Pal	27,50 x Cj 20,50 Neto
Roble Natural	90x55x5cm 35 7/16"x21 5/8"x1 15/16"	100120634 L172109841	G-175	1 x Cj 5 x Pal	27,50 x Cj 20,50 Neto
Nogal Americano	90x55x5cm 35 7/16"x21 5/8"x1 15/16"	100161237 L172113701	G-175	1 x Cj 5 x Pal	27,50 x Cj 20,50 Neto

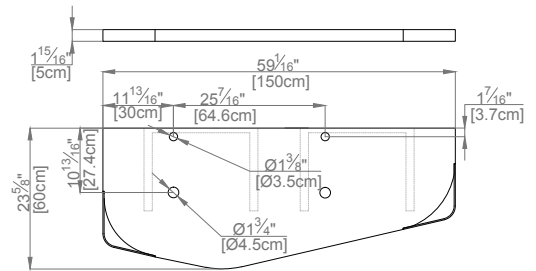

Men{H}ir Encimera L



MATT

The set includes / El conjunto incluye / L'ensemble comprend les éléments suivants:

- Countertop / Encimera / Tablettes
- Bracket / Escuadras de sujeción / Équerre de fixation
- Screws / Tornillería / Visserie

Description	Format	Codes	Group	Pcs	Kg
Roble Antracita	150x60x5cm 59 1/16"x23 5/8"x1 1/16"	100120596 L172109821	G-183	1 x Cj 5 x Pal	46,50 x Cj 37,50 Neto
Roble Natural	150x60x5cm 59 1/16"x23 5/8"x1 1/16"	100120643 L179702158	G-183	1 x Cj 5 x Pal	46,50 x Cj 37,50 Neto
Nogal Americano	150x60x5cm 59 1/16"x23 5/8"x1 1/16"	100161282 L179702659	G-183	1 x Cj 5 x Pal	46,50 x Cj 37,50 Neto



Faces

—

by Ramón Esteve



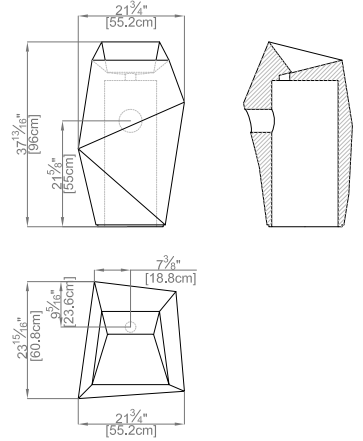

Faces Stand



The set includes / El conjunto incluye / L'ensemble comprend les éléments suivants:

- Wash basin / Lavabo / Lavabo
- Coupling / Junta de conexión / Joint de raccordement
- Maintenance kit / Kit de mantenimiento / Kit d'entretien

Description	Format	Codes	Group	Pcs	Kg
Persian White Classico	55,2x50,7x96cm 22 3/4"x20"x37 13/16"	100177109 L179702892	G-196	1 x Cj 1 x Pal	368 x Cj 308 Neto
Crema Italia Classico	55,2x50,7x96cm 22 3/4"x20"x37 13/16"	100156522 L179702589	G-196	1 x Cj 1 x Pal	368 x Cj 308 Neto
Grey Stone Classico	55,2x50,7x96cm 22 3/4"x20"x37 13/16"	100156523 L179702590	G-196	1 x Cj 1 x Pal	368 x Cj 308 Neto
Habana Dark Classico	55,2x50,7x96cm 22 3/4"x20"x37 13/16"	100156524 L179702591	G-196	1 x Cj 1 x Pal	368 x Cj 308 Neto

Qmax L/min=6 l/min (Pressure/Presión/Pression= 3 bar)

Compatible with / Compatible con / Compatible avec:

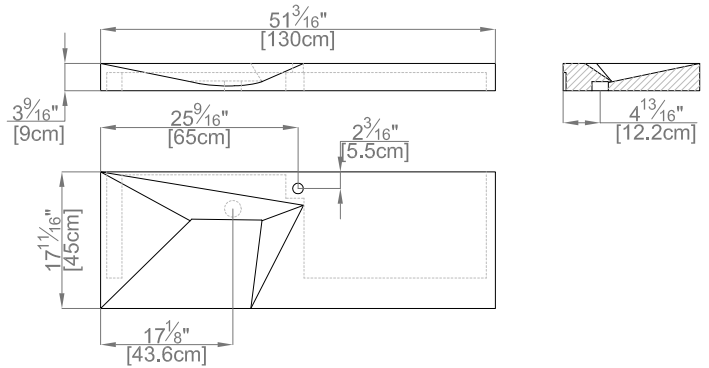

Faces Mural



The set includes / El conjunto incluye / L'ensemble comprend les éléments suivants:

- Wash basin / Lavabo / Lavabo
- Coupling / Junta de conexión / Joint de raccordement
- Bracket / Escuadra de sujeción / Équerre de fixation
- Screws / Tornillería / Visserie
- Maintenance kit / Kit de mantenimiento / Kit d'entretien

Description	Format	Codes	Group	Pcs	Kg
Persian White Classico	130x45x9cm 51 3/16"x17 11/16"x3 9/16"	100177118 L179702920	G-188	1 x Cj 6 x Pal	149 x Cj 96 Neto
Crema Italia Classico	130x45x9cm 51 3/16"x17 11/16"x3 9/16"	100161235 L179702675	G-188	1 x Cj 6 x Pal	149 x Cj 96 Neto
Grey Stone Classico	130x45x9cm 51 3/16"x17 11/16"x3 9/16"	100161137 L179702676	G-188	1 x Cj 6 x Pal	149 x Cj 96 Neto
Habana Dark Classico	130x45x9cm 51 3/16"x17 11/16"x3 9/16"	100161276 L179702698	G-188	1 x Cj 6 x Pal	149 x Cj 96 Neto

Qmax L/min=6 l/min (Pressure/Presión/Pression= 3 bar)

Compatible with / Compatible con / Compatible avec:



Faces

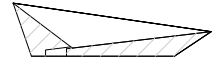
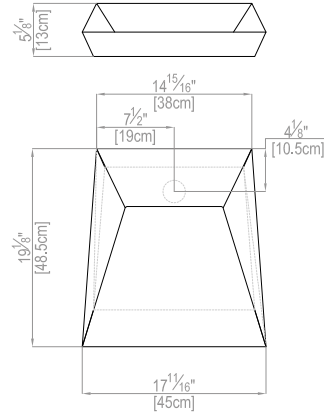

Faces



The set includes / El conjunto incluye /
L'ensemble comprend les éléments suivants:

-Wash basin / Lavabo / Lavabo
-Coupling / Junta de conexión / Joint de raccordement

Description	Format	Codes	Group	Pcs	Kg
Persian White Classico	45x48,5x13cm 17 11/16"x19 1/8"x5 1/8"	100177119 L179702914	G-182	1 x Cj 6 x Pal	31 x Cj 27 Neto
Crema Italia Classico	45x48,5x13cm 17 11/16"x19 1/8"x5 1/8"	100156488 L170302874	G-182	1 x Cj 6 x Pal	31 x Cj 27 Neto
Grey Stone Classico	45x48,5x13cm 17 11/16"x19 1/8"x5 1/8"	100156489 L170302873	G-182	1 x Cj 6 x Pal	31 x Cj 27 Neto
Habana Dark Classico	45x48,5x13cm 17 11/16"x19 1/8"x5 1/8"	100156520 L170302876	G-182	1 x Cj 6 x Pal	31 x Cj 27 Neto

Compatible with / Compatible con / Compatible avec:



ADAPTADOR DESAGÜE EUROPEA 6108099
100040079 - N292009900
NOKEN



USA SIFÓN PROJECT N
100209767 - N194710597
NOKEN



Qmax L/min=6 l/min (Pressure/Presión/Pression= 3 bar)

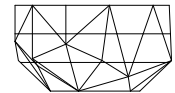
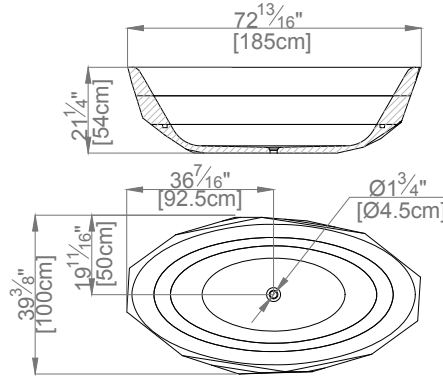

Faces Bañera



The set includes / El conjunto incluye /
L'ensemble comprend les éléments suivants:

-Bathtub / Bañera / Baignoires
-Installation kit / Kit de instalación / Kit d'installation
-Gasket / Junta de montaje / Joint de montage
-Maintenance kit / Kit de mantenimiento / Kit d'entretien

Description	Format	Codes	Group	Pcs	Kg
Persian White Classico	185x100x54cm 72 13/16"x39 3/8"x21 1/4"	100179168 L179703014	G-199	1 x Cj 1 x Pal	- -
Crema Italia Classico	185x100x54cm 72 13/16"x39 3/8"x21 1/4"	100179166 L179703013	G-199	1 x Cj 1 x Pal	- -
Grey Stone Classico	185x100x54cm 72 13/16"x39 3/8"x21 1/4"	100179167 L179703012	G-199	1 x Cj 1 x Pal	- -
Habana Dark Classico	185x100x54cm 72 13/16"x39 3/8"x21 1/4"	100179190 L179703011	G-199	1 x Cj 1 x Pal	- -



VACIADOR PULSADOR CLIKER SIN REBOSADERO
100110743 - N698350001
NOKEN



STONE WASTE COVER EMBELLECEDOR PIEDRA ÉLÉMENT DÉCORATIF PIERRE
Hidden-drain pedestals are available on order in the same material and with the same finish as that used for the bathtubs. / Los embellecedores del desagüe pueden realizarse bajo pedido con el mismo material y acabado que la bañera. / Sur demande, les éléments décoratifs du drain peuvent être fabriqués dans le même matériel et avec les mêmes finitions que le baignoires. (See page / Ver página / Voir page 157)

02

Faces

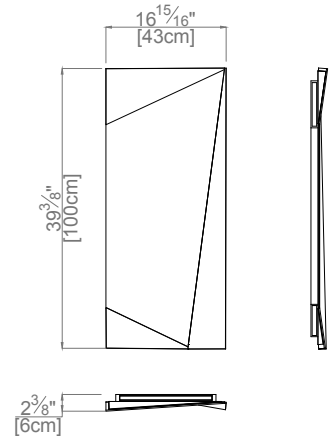

Faces Espejo Vertical



GLOSS

The set includes / *El conjunto incluye* /
L'ensemble comprend les éléments suivants:

-Mirrors / *Espejo* / *Miroir*
 -Screws / *Tornillería* / *Visserie*

Description	Format	Codes	Group	Pcs	Kg
Faces Espejo Vertical	43x100cm 16 7/8"x39 3/8"	100161527 L179702721	G-176	1 x Cj 1 x Pal	-



Illuminated mirror fitted with LEDs on the perimeter / *Iluminado perimetralmente en los pliegues con LEDs* / *Périmètre éclairé au niveau des plis avec des LED*

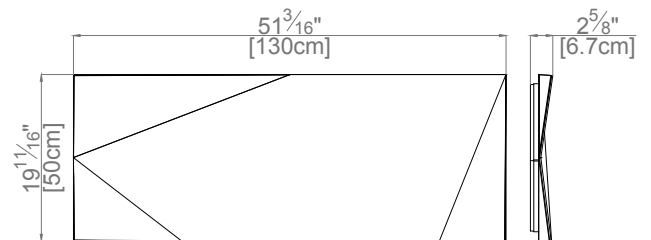

Faces Espejo Horizontal



GLOSS

The set includes / *El conjunto incluye* /
L'ensemble comprend les éléments suivants:

-Mirrors / *Espejo* / *Miroir*
 -Screws / *Tornillería* / *Visserie*

Description	Format	Codes	Group	Pcs	Kg
Faces Espejo Horizontal	130x50cm 51 1/8"x19 5/8"	100161508 L179702719	G-178	1 x Cj 1 x Pal	-



Illuminated mirror fitted with LEDs on the perimeter / *Iluminado perimetralmente en los pliegues con LEDs* / *Périmètre éclairé au niveau des plis avec des LED*



Complementary Products Faces Mural Habana Dark, Faces Espejo Horizontal



Minim

—

by Ramón Esteve

Complementary Products Minim Lavabo Stand Persian White, Minim Espejo 80x80cm

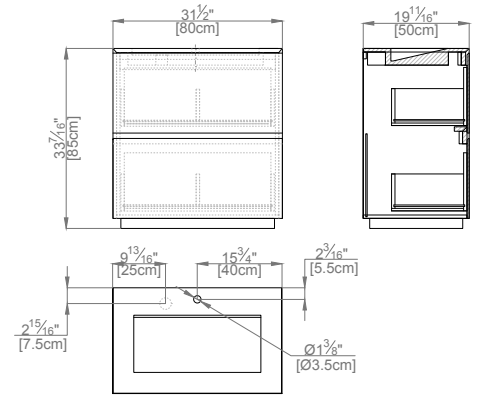

Minim Lavabo Stand



The set includes / *El conjunto incluye / L'ensemble comprend les éléments suivants:*

- Wash basin / *Lavabo / Lavabo*
- Coupling / *Junta de conexión / Joint de raccordement*
- Container box / *Caja contenedora / Caisson*
- Screws / *Tornillería / Visserie*
- Maintenance kit / *Kit de mantenimiento / Kit d'entretien*

Description	Format	Codes	Group	Pcs	Kg
Persian White Classico	80x85x50cm 31 1/2"x33 7/16"x19 11/16"	100177150 L179702928	G-193	1 x Cj 1 x Pal	179 x Cj 119 Neto
Crema Italia Classico	80x85x50cm 31 1/2"x33 7/16"x19 11/16"	100161324 L179702708	G-193	1 x Cj 1 x Pal	179 x Cj 119 Neto
Grey Stone Classico	80x85x50cm 31 1/2"x33 7/16"x19 11/16"	100161288 L179702699	G-193	1 x Cj 1 x Pal	179 x Cj 119 Neto
Habana Dark Classico	80x85x50cm 31 1/2"x33 7/16"x19 11/16"	100161333 L179702697	G-193	1 x Cj 1 x Pal	179 x Cj 119 Neto

Qmax L/min=7,5 l/min (Pressure/Presión/Pression= 3 bar)

Compatible with / *Compatible con / Compatible avec:*



ADAPTADOR DESAGÜE EUROPEA 6108099
100040079 - N292009900
NOKEN



USA SIFÓN PROJECT N
100209767 - N194710597
NOKEN

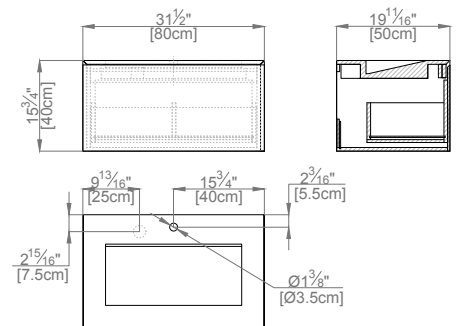

Minim Lavabo



The set includes / *El conjunto incluye / L'ensemble comprend les éléments suivants:*

- Wash basin / *Lavabo / Lavabo*
- Coupling / *Junta de conexión / Joint de raccordement*
- Container box / *Caja contenedora / Caisson*
- Screws / *Tornillería / Visserie*
- Maintenance kit / *Kit de mantenimiento / Kit d'entretien*

Description	Format	Codes	Group	Pcs	Kg
Persian White Classico	80x40x50cm 31 1/2"x15 3/4"x19 1/16"	100177139 L179702896	G-189	1 x Cj 1 x Pal	135 x Cj 82 Neto
Crema Italia Classico	80x40x50cm 31 1/2"x15 3/4"x19 1/16"	100161322 L179702687	G-189	1 x Cj 1 x Pal	135 x Cj 82 Neto
Grey Stone Classico	80x40x50cm 31 1/2"x15 3/4"x19 1/16"	100161323 L179702712	G-189	1 x Cj 1 x Pal	135 x Cj 82 Neto
Habana Dark Classico	80x40x50cm 31 1/2"x15 3/4"x19 1/16"	100161318 L179702695	G-189	1 x Cj 1 x Pal	135 x Cj 82 Neto

Qmax L/min=7,5 l/min (Pressure/Presión/Pression= 3 bar)

Compatible with / *Compatible con / Compatible avec:*



ADAPTADOR DESAGÜE EUROPEA 6108099
100040079 - N292009900
NOKEN



USA SIFÓN PROJECT N
100209767 - N194710597
NOKEN



Minim

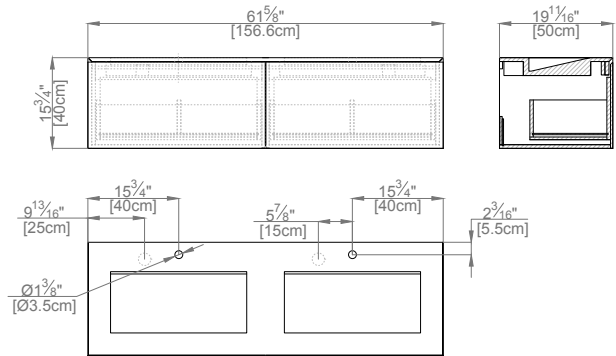

Minim Lavabo Doble



The set includes / El conjunto incluye / L'ensemble comprend les éléments suivants:

- Wash basin / Lavabo / Lavabo
- Coupling / Junta de conexión / Joint de raccordement
- Container box / Caja contenedora / Caisson
- Screws / Tornillería / Visserie
- Maintenance kit / Kit de mantenimiento / Kit d'entretien

Compatible with / Compatible con / Compatible avec:

Description	Format	Codes	Group	Pcs	Kg
Persian White Classico	156,6x40x50cm 61 5/8"x15 3/4"x19 5/8"	100177141 L179702895	G-195	1 x Cj 1 x Pal	240 x Cj 180 Neto
Crema Italia Classico	156,6x40x50cm 61 5/8"x15 3/4"x19 5/8"	100161316 L179702689	G-195	1 x Cj 1 x Pal	240 x Cj 180 Neto
Grey Stone Classico	156,6x40x50cm 61 5/8"x15 3/4"x19 5/8"	100161317 L179702681	G-195	1 x Cj 1 x Pal	240 x Cj 180 Neto
Habana Dark Classico	156,6x40x50cm 61 5/8"x15 3/4"x19 5/8"	100161287 L179702691	G-195	1 x Cj 1 x Pal	240 x Cj 180 Neto

Qmax L/min=7,5 l/min (Pressure/Presión/Pression= 3 bar)



ADAPTADOR DESAGÜE EUROPEA 6108099
100040079 - N292009900
NOKEN



USA SIFÓN PROJECT N
100209767 - N194710597
NOKEN

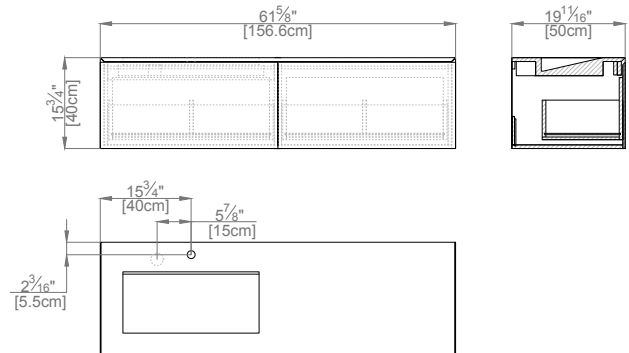

Minim Lavabo + Encimera



The set includes / El conjunto incluye / L'ensemble comprend les éléments suivants:

- Wash basin / Lavabo / Lavabo
- Coupling / Junta de conexión / Joint de raccordement
- Container box / Caja contenedora / Caisson
- Screws / Tornillería / Visserie
- Maintenance kit / Kit de mantenimiento / Kit d'entretien

Compatible with / Compatible con / Compatible avec:

Description	Format	Codes	Group	Pcs	Kg
Persian White Classico	156,6x40x50cm 61 5/8"x15 3/4"x19 5/8"	100177142 L179702897	G-194	1 x Cj 1 x Pal	218 x Cj 158 Neto
Crema Italia Classico	156,6x40x50cm 61 5/8"x15 3/4"x19 5/8"	100161289 L179702692	G-194	1 x Cj 1 x Pal	218 x Cj 158 Neto
Grey Stone Classico	156,6x40x50cm 61 5/8"x15 3/4"x19 5/8"	100161340 L179702671	G-194	1 x Cj 1 x Pal	218 x Cj 158 Neto
Habana Dark Classico	156,6x40x50cm 61 5/8"x15 3/4"x19 5/8"	100161334 L179702705	G-194	1 x Cj 1 x Pal	218 x Cj 158 Neto

Qmax L/min=7,5 l/min (Pressure/Presión/Pression= 3 bar)



ADAPTADOR DESAGÜE EUROPEA 6108099
100040079 - N292009900
NOKEN



USA SIFÓN PROJECT N
100209767 - N194710597
NOKEN



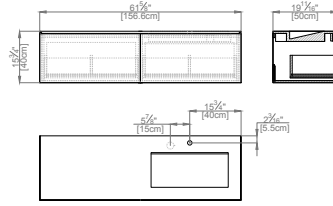

Minim Encimera + Lavabo



The set includes / El conjunto incluye / L'ensemble comprend les éléments suivants:

- Wash basin / Lavabo / Lavabo
- Coupling / Junta de conexión / Joint de raccordement
- Container box / Caja contenedora / Caisson
- Screws / Tornillería / Visserie
- Maintenance kit / Kit de mantenimiento / Kit d'entretien

Description	Format	Codes	Group	Pcs	Kg
Persian White Classico	156,6x40x50cm 61 5/8"x15 3/4"x19 5/8"	100177138 L179702894	G-194	1 x Cj 1 x Pal	218 x Cj 158 Neto
Crema Italia Classico	156,6x40x50cm 61 5/8"x15 3/4"x19 5/8"	100161320 L179702680	G-194	1 x Cj 1 x Pal	218 x Cj 158 Neto
Grey Stone Classico	156,6x40x50cm 61 5/8"x15 3/4"x19 5/8"	100161330 L179702710	G-194	1 x Cj 1 x Pal	218 x Cj 158 Neto
Habana Dark Classico	156,6x40x50cm 61 5/8"x15 3/4"x19 5/8"	100161321 L179702702	G-194	1 x Cj 1 x Pal	218 x Cj 158 Neto

Qmax L/min=7,5 l/min (Pressure/Presión/Pression= 3 bar)

Compatible with / Compatible con / Compatible avec:



ADAPTADOR DESAGÜE EUROPEA 6108099
100040079 - N292009900
NOKEN



USA SIFÓN PROJECT N
100209767 - N194710597
NOKEN



Wall Coverings Habana Grey Classico / Complementary Products Minim Encimera + Lavabo Grey Stone, Minim Espejo 160x60

Minim

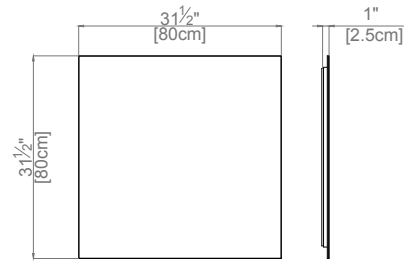

Minim Espejo 80x80cm



The set includes / *El conjunto incluye / L'ensemble comprend les éléments suivants:*

-Mirrors / *Espejo / Miroir*
-Screws / *Tornillería / Visserie*

Description	Format	Codes	Group	Pcs	Kg
Minim Espejo	80x80cm 31 1/2"x31 1/2"	100161542 L179702720	G-175	1 x Cj 10 x Pal	- -



Illuminated mirror fitted with LEDs on the perimeter / *Iluminado perimetralmente en los pliegues con LEDs / Périètre éclairé au niveau des plis avec des LED*

Steam free mirror with built-in demister / *Espejo con Sistema Antivaho incorporado que evita que se empañe / Miroir avec système anti-buée intégré qui empêche que s'embue.*

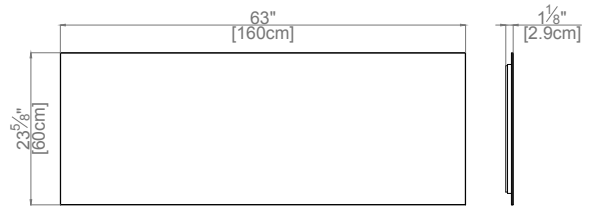

Minim Espejo 160x60cm



The set includes / *El conjunto incluye / L'ensemble comprend les éléments suivants:*

-Mirrors / *Espejo / Miroir*
-Screws / *Tornillería / Visserie*

Description	Format	Codes	Group	Pcs	Kg
Minim Espejo	160x60cm 63"x23 5/8"	100161560 L179702722	G-178	1 x Cj 1 x Pal	- -



Illuminated mirror fitted with LEDs on the perimeter / *Iluminado perimetralmente en los pliegues con LEDs / Périètre éclairé au niveau des plis avec des LED*

Steam free mirror with built-in demister / *Espejo con Sistema Antivaho incorporado que evita que se empañe / Miroir avec système anti-buée intégré qui empêche que s'embue.*



Minim Wood

—

by Ramón Esteve



Complementary Products Minim Wood Roble Beige - Crema Italia, Minim Espejo 80x80cm

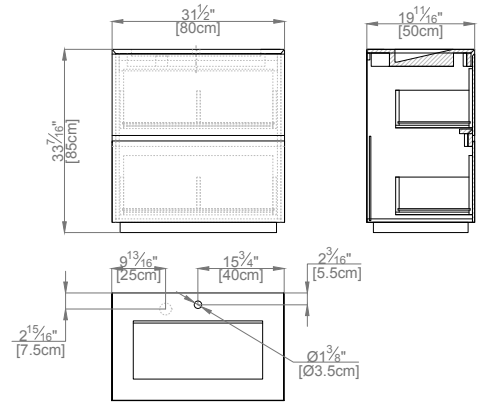

Minim Wood Stand



The set includes / *El conjunto incluye / L'ensemble comprend les éléments suivants:*

- Wash basin / *Lavabo / Lavabo*
- Coupling / *Junta de conexión / Joint de raccordement*
- Container box / *Caja contenedora / Caisson*
- Screws / *Tornillería / Visserie*
- Maintenance kit / *Kit de mantenimiento / Kit d'entretien*

Description	Format	Codes	Group	Pcs	Kg
Roble Snow / Persian White Classico	80x50x85cm 31 1/2"x19 11/16"x33 7/16"	100179676 L179702997	G-193	1 x Cj 1 x Pal	165,6 x Cj 165,6 x Pal
Roble Beige / Crema Italia Classico	80x50x85cm 31 1/2"x19 11/16"x33 7/16"	100179675 L179702994	G-193	1 x Cj 1 x Pal	165,6 x Cj 165,6 x Pal
Roble Grey / Grey Stone Classico	80x50x85cm 31 1/2"x19 11/16"x33 7/16"	100179656 L179702993	G-193	1 x Cj 1 x Pal	165,6 x Cj 165,6 x Pal
Roble Earth / Habana Dark Classico	80x50x85cm 31 1/2"x19 11/16"x33 7/16"	100179657 L179702996	G-193	1 x Cj 1 x Pal	165,6 x Cj 165,6 x Pal

Qmax L/min=7,5 l/min (Pressure/Presión/Pression= 3 bar)

Compatible with / *Compatible con / Compatible avec:*



ADAPTADOR DESAGÜE EUROPEA 6108099
100040079 - N292009900
NOKEN



USA SIFÓN PROJECT N
100209767 - N194710597
NOKEN

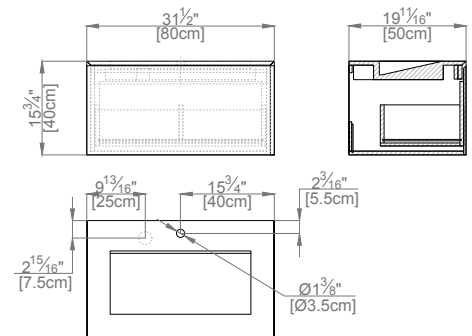

Minim Wood



The set includes / *El conjunto incluye / L'ensemble comprend les éléments suivants:*

- Wash basin / *Lavabo / Lavabo*
- Coupling / *Junta de conexión / Joint de raccordement*
- Container box / *Caja contenedora / Caisson*
- Screws / *Tornillería / Visserie*
- Maintenance kit / *Kit de mantenimiento / Kit d'entretien*

Description	Format	Codes	Group	Pcs	Kg
Roble Snow / Persian White Classico	80x50x40cm 31 1/2"x19 11/16"x15 3/4"	100179674 L179703017	G-189	1 x Cj 1 x Pal	77,93 x Cj 77,93 x Pal
Roble Beige / Crema Italia Classico	80x50x40cm 31 1/2"x19 11/16"x15 3/4"	100179612 L179703015	G-189	1 x Cj 1 x Pal	77,93 x Cj 77,93 x Pal
Roble Grey / Grey Stone Classico	80x50x40cm 31 1/2"x19 11/16"x15 3/4"	100179596 L179703018	G-189	1 x Cj 1 x Pal	77,93 x Cj 77,93 x Pal
Roble Earth / Habana Dark Classico	80x50x40cm 31 1/2"x19 11/16"x15 3/4"	100179584 L179703016	G-189	1 x Cj 1 x Pal	77,93 x Cj 77,93 x Pal

Qmax L/min=7,5 l/min (Pressure/Presión/Pression= 3 bar)

Compatible with / *Compatible con / Compatible avec:*



ADAPTADOR DESAGÜE EUROPEA 6108099
100040079 - N292009900
NOKEN



USA SIFÓN PROJECT N
100209767 - N194710597
NOKEN



Minim Wood

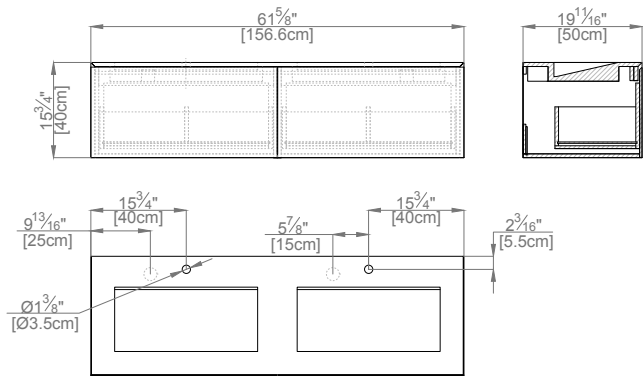

Minim Wood Doble



The set includes / El conjunto incluye /
L'ensemble comprend les éléments suivants:

- Wash basin / Lavabo / Lavabo
- Coupling / Junta de conexión / Joint de raccordement
- Container box / Caja contenedora / Caisson
- Screws / Tornillería / Visserie
- Maintenance kit / Kit de mantenimiento / Kit d'entretien

Compatible with / Compatible con / Compatible avec:

Description	Format	Codes	Group	Pcs	Kg
Roble Snow / Persian White Classico	156,6x50x40cm 61 5/8"x19 11/16"x15 3/4"	100179613 L179702986	G-195	1 x Cj 1 x Pal	228 x Cj 228 x Pal
Roble Beige / Crema Italia	156,6x50x40cm 61 5/8"x19 11/16"x15 3/4"	100179602 L179702991	G-195	1 x Cj 1 x Pal	228 x Cj 228 x Pal
Roble Grey / Grey Stone	156,6x50x40cm 61 5/8"x19 11/16"x15 3/4"	100179595 L179702988	G-195	1 x Cj 1 x Pal	228 x Cj 228 x Pal
Roble Earth / Habana Dark	156,6x50x40cm 61 5/8"x19 11/16"x15 3/4"	100179603 L179702990	G-195	1 x Cj 1 x Pal	228 x Cj 228 x Pal

Qmax L/min=7,5 l/min (Pressure/Presión/Pression= 3 bar)



ADAPTADOR DESAGÜE EUROPEA 6108099
100040079 - N292009900
NOKEN



USA SIFÓN PROJECT N
100209767 - N194710597
NOKEN

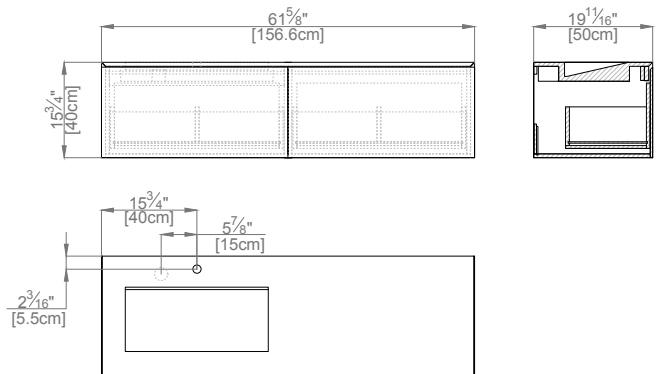

Minim Wood Lavabo + Encimera



The set includes / El conjunto incluye /
L'ensemble comprend les éléments suivants:

- Wash basin / Lavabo / Lavabo
- Coupling / Junta de conexión / Joint de raccordement
- Container box / Caja contenedora / Caisson
- Screws / Tornillería / Visserie
- Maintenance kit / Kit de mantenimiento / Kit d'entretien

Compatible with / Compatible con / Compatible avec:

Description	Format	Codes	Group	Pcs	Kg
Roble Snow / Persian White Classico	156,6x50x40cm 61 5/8"x19 11/16"x15 3/4"	100179632 L179702995	G-194	1 x Cj 1 x Pal	228 x Cj 228 x Pal
Roble Beige / Crema Italia Classico	156,6x50x40cm 61 5/8"x19 11/16"x15 3/4"	100179618 L179702989	G-194	1 x Cj 1 x Pal	228 x Cj 228 x Pal
Roble Grey / Grey Stone Classico	156,6x50x40cm 61 5/8"x19 11/16"x15 3/4"	100179631 L179702992	G-194	1 x Cj 1 x Pal	228 x Cj 228 x Pal
Roble Earth / Habana Dark Classico	156,6x50x40cm 61 5/8"x19 11/16"x15 3/4"	100179585 L179702984	G-194	1 x Cj 1 x Pal	228 x Cj 228 x Pal

Qmax L/min=7,5 l/min (Pressure/Presión/Pression= 3 bar)



ADAPTADOR DESAGÜE EUROPEA 6108099
100040079 - N292009900
NOKEN



USA SIFÓN PROJECT N
100209767 - N194710597
NOKEN



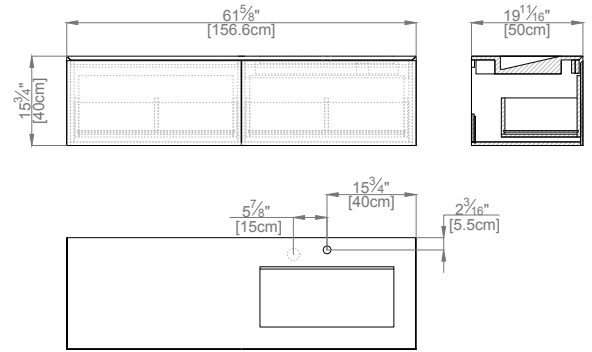

Minim Wood
Encimera + Lavabo



The set includes / El conjunto incluye /
L'ensemble comprend les éléments suivants:

- Wash basin / Lavabo / Lavabo
- Coupling / Junta de conexión / Joint de raccordement
- Container box / Caja contenedora / Caisson
- Screws / Tornillería / Visserie
- Maintenance kit / Kit de mantenimiento / Kit d'entretien

Description	Format	Codes	Group	Pcs	Kg
Roble Snow / Persian White Classico	156,6x50x40cm 61 5/8"x19 11/16"x15 3/4"	100179617 L179702983	G-194	1 x Cj 1 x Pal	228 x Cj 228 x Pal
Roble Beige / Crema Italia Classico	156,6x50x40cm 61 5/8"x19 11/16"x15 3/4"	100179614 L179702982	G-194	1 x Cj 1 x Pal	228 x Cj 228 x Pal
Roble Grey / Grey Stone Classico	156,6x50x40cm 61 5/8"x19 11/16"x15 3/4"	100179616 L179702987	G-194	1 x Cj 1 x Pal	228 x Cj 228 x Pal
Roble Earth / Habana Dark Classico	156,6x50x40cm 61 5/8"x19 11/16"x15 3/4"	100179615 L179702985	G-194	1 x Cj 1 x Pal	228 x Cj 228 x Pal

Compatible with / Compatible con / Compatible avec:



ADAPTADOR DESAGÜE EUROPEA 6108099
100040079 - N292009900
NOKEN



USA SIFÓN PROJECT N
100209767 - N194710597
NOKEN



Qmax L/min=7,5 l/min (Pressure/Presión/Pression= 3 bar)



Complementary Products Minim Wood Roble Earth - Habana Dark



Complementary Products Minim Wood Roble Beige - Crema Italia, Minim Espejo 80x80cm



Azrama

—
by Clodagh

Complementary Products Azrama Primitive Vanity

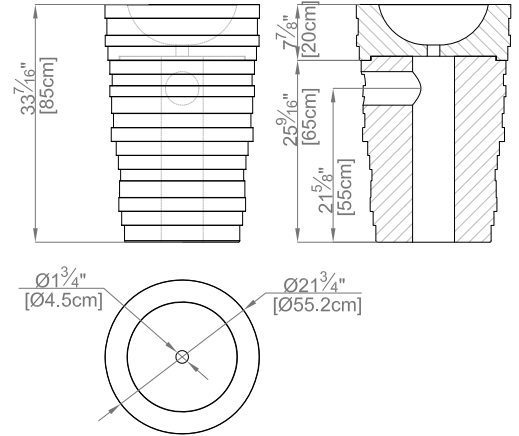

Azrama Primitive Vanity



The set includes / *El conjunto incluye / L'ensemble comprend les éléments suivants:*

-Wash basin / *Lavabo / Lavabo*
-Maintenance kit / *Kit de mantenimiento / Kit d'entretien*

Description	Format	Codes	Group	Pcs	Kg
Habana Brown Classico	55,2x55,2x85cm 21 3/4"x21 3/4"x33 7/16"	100142876 L179702352	G-193	1 x Cj 1 x Pal	437 x Cj 377 Neto

Qmax L/min=12 l/min (Pressure/Presión/Pression= 3 bar)



VACIADOR FIJO TAPA PIEDRA COMPATIBLE USA
Included / Includo / Inclus



Compatible with / *Compatible con / Compatible avec:*



USA SIFÓN PROJECT N
100209767 - N194710597
NOKEN



Superficie exterior texturada

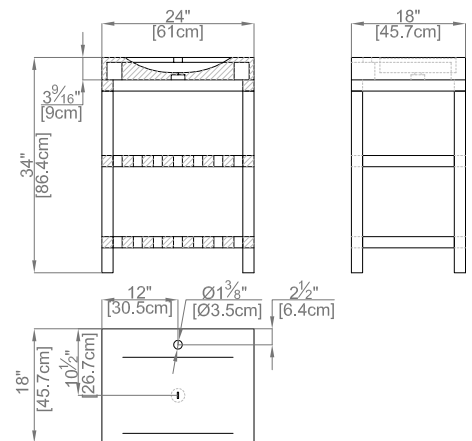

Azrama Vanity Single



The set includes / *El conjunto incluye / L'ensemble comprend les éléments suivants:*

-Wash basin / *Lavabo / Lavabo*
-Coupling / *Junta de conexión / Joint de raccordement*
-Furniture / *Mueble / Meuble*

Description	Format	Codes	Group	Pcs	Kg
Habana Brown / Iroko	61x84,6x45,7cm 24"x34"x18"	100146487 L179702442	G-188	1 x Cj 1 x Pal	90 x Cj 53 Neto

Qmax L/min=12 l/min (Pressure/Presión/Pression= 3 bar)



ADAPTADOR DESAGÜE EUROPEA 6108099
100040079 - N292009900
NOKEN



USA SIFÓN PROJECT N
100209767 - N194710597
NOKEN



Recommended taps / *Griferías recomendadas / Robinetteries recommandées*

HOTELS 100126422 - N194710553

URBAN 100121305 - N199999610
(con aireador)

LIBRA* 100038646 - N160010001
(con aireador)
NOKEN

*Only EEUU / *Sólo EEUU / Seulement EEUU*

Azrama



Superficie exterior texturada

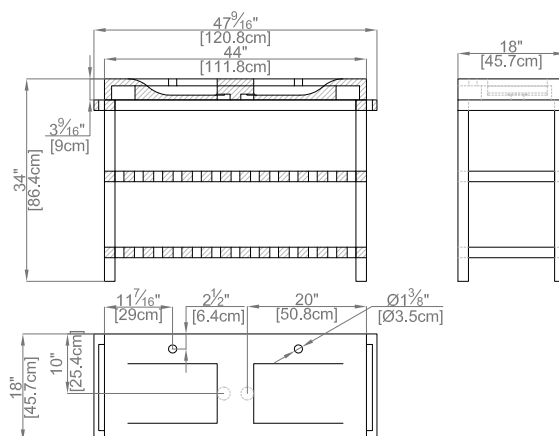

Azrama Vanity Double



MATT



FREE-STANDING WASHBASIN



BIOPROT

The set includes / El conjunto incluye / L'ensemble comprend les éléments suivants:

- Wash basin / Lavabo / Lavabo
- Coupling / Junta de conexión / Joint de raccordement
- Forniture / Mueble / Meuble

Compatible with / Compatible con / Compatible avec:

Description	Format	Codes	Group	Pcs	Kg
Habana Brown / Iroko	120,8x86,4x45,7cm 44"x34"x18"	100146486 L179702417	G-195	1 x Cj 1 x Pal	140 x Cj 99 Neto

Qmax L/min=12 l/min (Pressure/Presión/Pression= 3 bar)



ADAPTADOR DESAGÜE EUROPEA 6108099
100040079 - N292009900
NOKEN



USA SIFÓN PROJECT N
100209767 - N194710597
NOKEN



Superficie exterior texturada

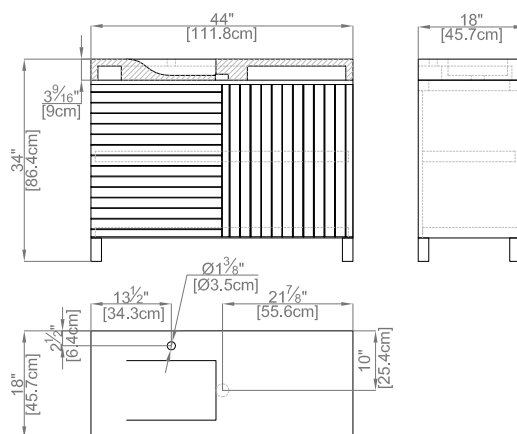

Azrama Vanity Doors



MATT



FREE-STANDING WASHBASIN



BIOPROT

The set includes / El conjunto incluye / L'ensemble comprend les éléments suivants:

- Wash basin / Lavabo / Lavabo
- Coupling / Junta de conexión / Joint de raccordement
- Forniture / Mueble / Meuble

Compatible with / Compatible con / Compatible avec:

Description	Format	Codes	Group	Pcs	Kg
Habana Brown / Iroko	111,8x86,4x45,7cm 44"x34"x18"	100146485 L179702458	G-195	1 x Cj 1 x Pal	151 x Cj 110 Neto

Qmax L/min=12 l/min (Pressure/Presión/Pression= 3 bar)



ADAPTADOR DESAGÜE EUROPEA 6108099
100040079 - N292009900
NOKEN



USA SIFÓN PROJECT N
100209767 - N194710597
NOKEN



Spirit

—

by A-cero



Complementary Products Spirit Lavabo A-cero Gloss, Spirit Mueble Roble Intenso, Spirit Espejo Neboa



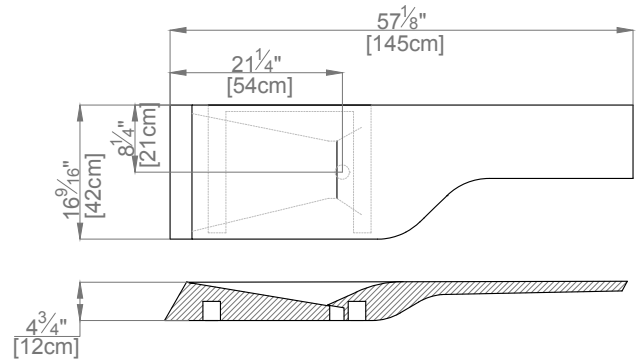

Spirit Lavabo



The set includes / El conjunto incluye / L'ensemble comprend les éléments suivants:

- Wash basin / Lavabo / Lavabo
- Coupling / Junta de conexión / Joint de raccordement
- Bracket / Escuadra de sujeción / Équerre de fixation
- Screws / Tornillería / Visserie
- Maintenance kit / Kit de mantenimiento / Kit d'entretien

Description	Format	Codes	Group	Pcs	Kg
A-cero Dark	145x42x12cm 57 1/8"x16 9/16"x4 3/4"	100098337 L171301224	G-189	1 x Cj 1 x Pal	125 x Cj 89 Neto
A-cero Gloss	145x42x12cm 57 1/8"x16 9/16"x4 3/4"	100098331 L171301223	G-189	1 x Cj 1 x Pal	125 x Cj 89 Neto

Qmax L/min=10 l/min (Pressure/Presión/Pression= 3 bar)

Compatible with / Compatible con / Compatible avec:



ADAPTADOR DESAGÜE EUROPEA 6108099
100040079 - N292009900
NOKEN



USA SIFÓN PROJECT N
100209767 - N194710597
NOKEN

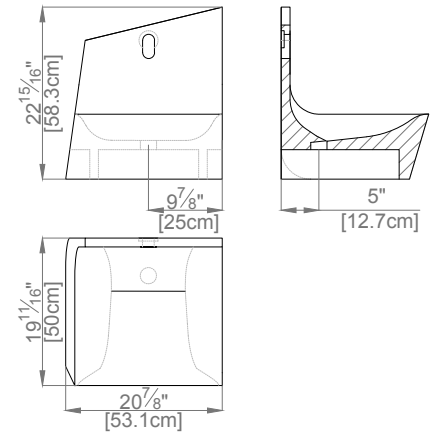

Spirit II Lavabo



The set includes / El conjunto incluye / L'ensemble comprend les éléments suivants:

- Wash basin / Lavabo / Lavabo
- Coupling / Junta de conexión / Joint de raccordement
- Bracket / Escuadra de sujeción / Équerre de fixation
- Screws / Tornillería / Visserie
- Maintenance kit / Kit de mantenimiento / Kit d'entretien

Description	Format	Codes	Group	Pcs	Kg
A-cero Dark	53,1x50cm 20 7/8"x19 11/16"	100112177 L170302655	G-192	1 x Cj 1 x Pal	130 x Cj 95 Neto
A-cero Gloss	53,1x50cm 20 7/8"x19 11/16"	100112178 L170302656	G-192	1 x Cj 1 x Pal	130 x Cj 95 Neto

Qmax L/min=6,5 l/min (Pressure/Presión/Pression= 3 bar)

Compatible with / Compatible con / Compatible avec:



ADAPTADOR DESAGÜE EUROPEA 6108099
100040079 - N292009900
NOKEN



USA SIFÓN PROJECT N
100209767 - N194710597
NOKEN



GRIFERÍA LOUNGE AIREADOR
100063522 - N199999990
100098000 - N299999432
NOKEN

Spirit

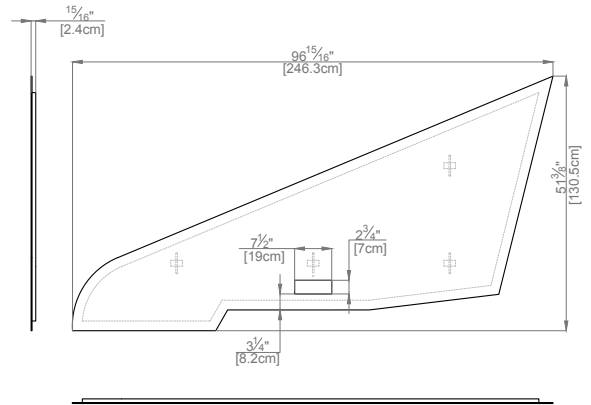

Spirit Espejo Neboa



The set includes / El conjunto incluye /
L'ensemble comprend les éléments suivants:

-Mirrors / Espejo / Miroir
-Screws / Tornillería / Visserie

Compatible with / Compatible con / Compatible avec:

Descripción	Formato	Códigos	Grupo	Pz	Kg
Spirit Espejo Neboa	246,3x130,5cm 96 15/16"x51 3/8"	100098330 L179702086	G-178	1 x Cj 5 x Pal	82,80 x Cj 31,80 Neto



EEUU / NK LOGIC
100143677 - N140140074
NOKEN



**MONOMANDO LAVABO ENCASTRE.
IRTA.WBAS IRTA MIXER TAP ENC.**
100038708 - N161011301
NOKEN

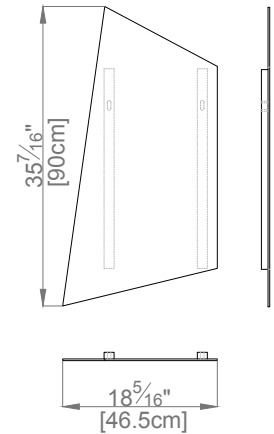

Spirit II Espejo



The set includes / El conjunto incluye /
L'ensemble comprend les éléments suivants:

-Mirrors / Espejo / Miroir
-Screws / Tornillería / Visserie

Descripción	Formato	Códigos	Grupo	Pz	Kg
Spirit Espejo II	90x46,5cm 35 7/16"x18 5/16"	100112176 L175000023	G-171	1 x Cj 5 x Pal	13,85 x Cj 6 Neto

02

Spirit

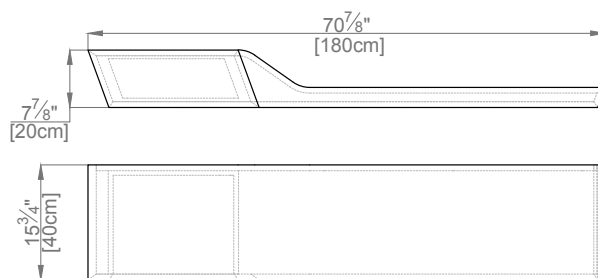

Spirit Mueble



MATT

The set includes / *El conjunto incluye* / -Furniture / *Mueble* / *Meuble*
L'ensemble comprend les éléments suivants: -Screws / *Tornillería* / *Visserie*

Description	Format	Codes	Group	Pcs	Kg
Roble Ceniza	180x20x40cm 70 7/8"x7 7/8"x15 3/4"	100098321 L175000015	G-184	1 x Cj 8 x Pal	13,85 x Cj 6 Neto
Roble Intenso	180x20x40cm 70 7/8"x7 7/8"x15 3/4"	100098322 L175000016	G-184	1 x Cj 8 x Pal	13,85 x Cj 6 Neto



Complementary Products Spirit Lavabo A-cero Dark, Spirit Mueble Roble Ceniza



Complementary Products Spirit II Lavabo A-cero Gloss, Spirit II Espejo

Saint Germain

by Lázaro Rosa-Violán



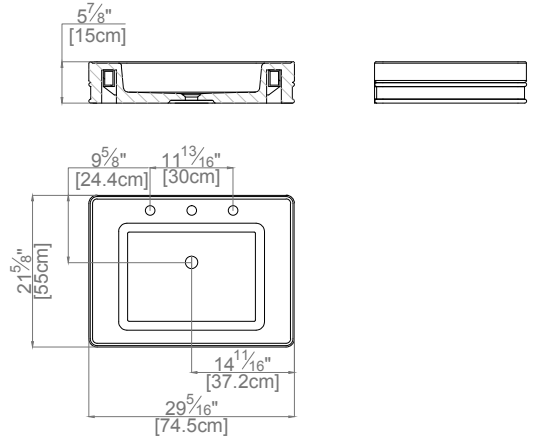

Saint Germain
Lavabo



The set includes / El conjunto incluye / L'ensemble comprend les éléments suivants:

- Wash basin / Lavabo / Lavabo
- Bracket / Escuadra de sujeción / Équerre de fixation
- Screws / Tornillería / Visserie
- Maintenance kit / Kit de mantenimiento / Kit d'entretien

Description	Format	Codes	Group	Pcs	Kg
Blanc	74,5x55x15cm 29 5/16"x21 5/8"x5 7/8"	100179773 L179703034	G-181	1 x Cj 1 x Pal	103,52 x Cj 103,52 x Pal
Noir	74,5x55x15cm 29 5/16"x21 5/8"x5 7/8"	100179764 L179703024	G-181	1 x Cj 1 x Pal	103,52 x Cj 103,52 x Pal

Qmax L/min=12 l/min (Pressure/Presión/Pression= 3 bar)



VACIADOR FIJO TAPA
PIEDRA COMPATIBLE USA
Included / Incluido / Inclus



Compatible with / Compatible con / Compatible avec:



USA SIFÓN PROJECT N
100209767 - N194710597
NOKEN

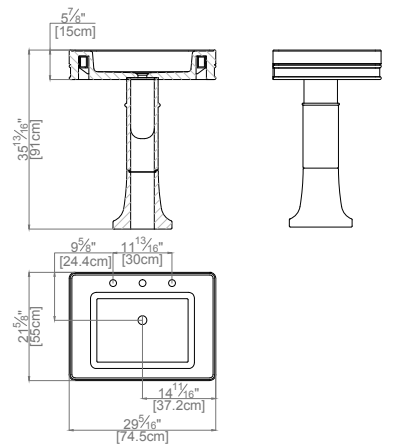

Saint Germain
Totem



The set includes / El conjunto incluye / L'ensemble comprend les éléments suivants:

- Wash basin / Lavabo / Lavabo
- Bracket / Escuadra de sujeción / Équerre de fixation
- Screws / Tornillería / Visserie
- Maintenance kit / Kit de mantenimiento / Kit d'entretien

Description	Format	Codes	Group	Pcs	Kg
Washbasin Blanc / Base Blanc	74,5x55x91cm 29 5/16"x21 5/8"x35 13/16"	100179776 L179703003	G-193	1 x Cj 1 x Pal	218,72 x Cj 218,72 x Pal
Washbasin Blanc / Base Noir	74,5x55x91cm 29 5/16"x21 5/8"x35 13/16"	100179787 L179703026	G-193	1 x Cj 1 x Pal	218,72 x Cj 218,72 x Pal
Washbasin Noir / Base Noir	74,5x55x91cm 29 5/16"x21 5/8"x35 13/16"	100179790 L179703005	G-193	1 x Cj 1 x Pal	218,72 x Cj 218,72 x Pal
Washbasin Noir / Base Blanc	74,5x55x91cm 29 5/16"x21 5/8"x35 13/16"	100179779 L179703007	G-193	1 x Cj 1 x Pal	218,72 x Cj 218,72 x Pal

Qmax L/min=12 l/min (Pressure/Presión/Pression= 3 bar)



VACIADOR FIJO TAPA
PIEDRA COMPATIBLE USA
Included / Incluido / Inclus



Compatible with / Compatible con / Compatible avec:



USA SIFÓN PROJECT N
100209767 - N194710597
NOKEN



Saint Germain



Saint Germain Totem Crochet



The set includes / El conjunto incluye /
L'ensemble comprend les éléments suivants:

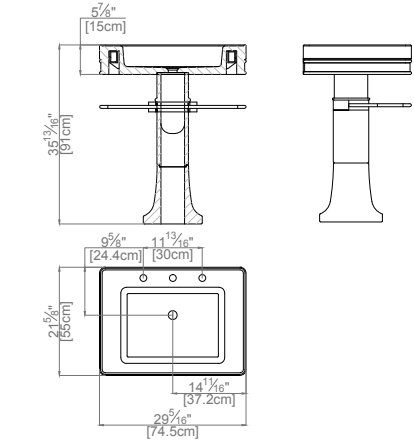

- Wash basin / Lavabo / Lavabo
- Bracket / Escuadra de sujeción / Équerre de fixation
- Screws / Tornillería / Visserie
- Maintenance kit / Kit de mantenimiento / Kit d'entretien

Description	Format	Codes	Group	Pcs	Kg
Washbasin Blanc / Base Blanc	74,5x55x91 cm 29 5/16"x21 5/8"x35 13/16"	100179777 L179703027	G-194	1 x Cj 1 x Pal	218,72 x Cj 218,72 x Pal
Washbasin Blanc / Base Noir	74,5x55x91 cm 29 5/16"x21 5/8"x35 13/16"	100179788 L179703033	G-194	1 x Cj 1 x Pal	218,72 x Cj 218,72 x Pal
Washbasin Noir / Base Noir	74,5x55x91 cm 29 5/16"x21 5/8"x35 13/16"	100179778 L179703019	G-194	1 x Cj 1 x Pal	218,72 x Cj 218,72 x Pal
Washbasin Noir / Base Blanc	74,5x55x91 cm 29 5/16"x21 5/8"x35 13/16"	100179766 L179703006	G-194	1 x Cj 1 x Pal	218,72 x Cj 218,72 x Pal

Qmax L/min=12 l/min (Pressure/Presión/Pression= 3 bar)



VACIADOR FIJO TAPA
PIEDRA COMPATIBLE USA
Included / Includo / Inclus



Compatible with / Compatible con / Compatible avec:



USA SIFÓN PROJECT N
100209767 - N194710597
NOKEN



Saint Germain Structure



The set includes / El conjunto incluye /
L'ensemble comprend les éléments suivants:

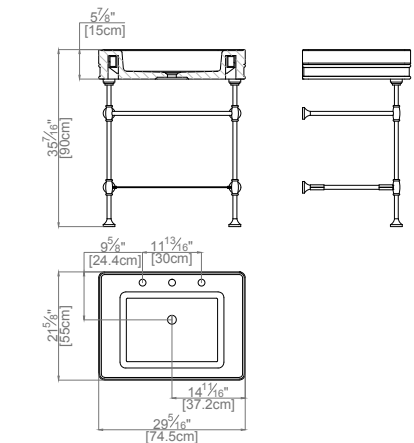

- Wash basin / Lavabo / Lavabo
- Bracket / Escuadra de sujeción / Équerre de fixation
- Screws / Tornillería / Visserie
- Maintenance kit / Kit de mantenimiento / Kit d'entretien

Description	Format	Codes	Group	Pcs	Kg
Blanc	74,5x55cm 29 5/16"x21 5/8"x35 7/16"	100179774 L179703023	G-193	1 x Cj 1 x Pal	129,39 x Cj 129,39 x Pal
Noir	74,5x55cm 29 5/16"x21 5/8"x35 7/16"	100179775 L179703004	G-193	1 x Cj 1 x Pal	129,39 x Cj 129,39 x Pal

Qmax L/min=12 l/min (Pressure/Presión/Pression= 3 bar)



VACIADOR FIJO TAPA
PIEDRA COMPATIBLE USA
Included / Includo / Inclus



Compatible with / Compatible con / Compatible avec:



USA SIFÓN PROJECT N
100209767 - N194710597
NOKEN



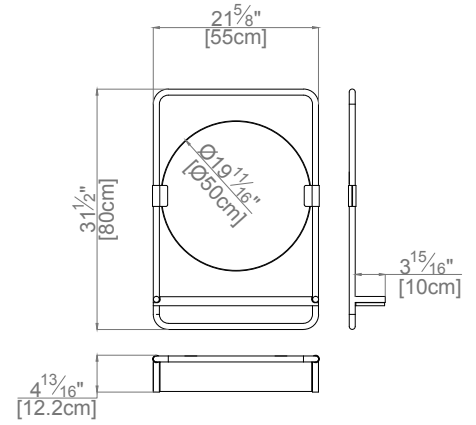

Saint Germain Espejo Étagère



GLOSS

The set includes / *El conjunto incluye* /
L'ensemble comprend les éléments suivants:

-Mirrors / *Espejo / Miroir*
-Screws / *Tornillería / Visserie*

Description	Format	Codes	Group	Pcs	Kg
Blanc	55x80cm 21 5/8"x31 1/2"x4 13/16"	100179810 L179703035	G-181	1 x Cj 1 x Pal	9,86 x Cj 9,86 x Pal
Noir	55x80cm 21 5/8"x31 1/2"x4 13/16"	100179792 L179703028	G-181	1 x Cj 1 x Pal	9,86 x Cj 9,86 x Pal

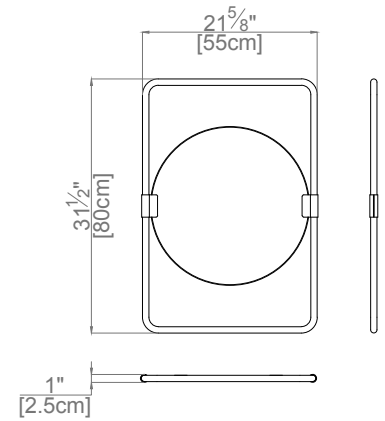

Saint Germain Espejo Tour



GLOSS

The set includes / *El conjunto incluye* /
L'ensemble comprend les éléments suivants:

-Mirrors / *Espejo / Miroir*
-Screws / *Tornillería / Visserie*

Description	Format	Codes	Group	Pcs	Kg
Saint Germain Espejo Tour	55x80x2,5cm 21 5/8"x31 1/2"x1"	100179772 L179703031	G-178	1 x Cj 1 x Pal	7,79 x Cj 7,79 x Pal

Saint Germain

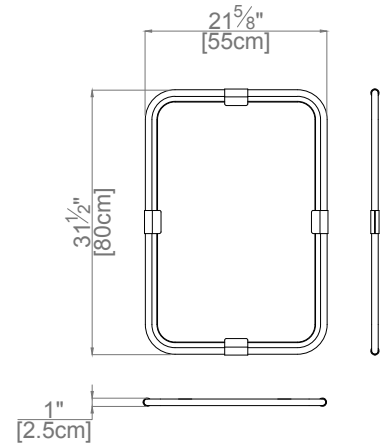

Bathrooms

Saint Germain Espejo Place



The set includes / *El conjunto incluye* /
L'ensemble comprend les éléments suivants:

-Mirrors / *Espejo* / *Miroir*
-Screws / *Tornillería* / *Visserie*

Description	Format	Codes	Group	Pcs	m2	Kg
Saint Germain Espejo Place	55x80x2,5cm 21 5/8"x31 1/2"x1"	100179811 L179703020	G-178	1 x Cj 1 x Pal	- -	7,79 x Cj 7,79 x Pal



Wall Coverings Calpe Nieve, Javea Black / Complementary Products Saint Germain Totem Crochet Blanc - Noir



Saint Denis

—
by Lázaro Rosa-Violán

Complementary Products Saint Denis Lavabo Noir

02

Saint Denis

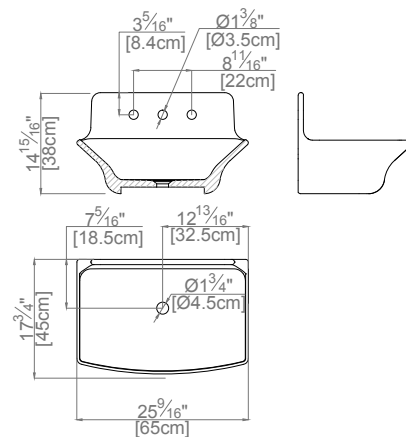
Saint Denis
Lavabo

MATT

WASHBASIN ON
SUPPORT

BIOPROT

The set includes / *El conjunto incluye* /
L'ensemble comprend les éléments suivants:

-Wash basin / *Lavabo* / *Lavabo*
-Bracket / *Escudra de sujeción* / *Équerre de fixation*
-Screws / *Tornillería* / *Visserie*
-Maintenance kit / *Kit de mantenimiento* / *Kit d'entretien*

Description	Format	Codes	Group	Pcs	Kg
Blanc	65x45x38cm 25 9/16"x17 3/4"x14 15/16"	100179791 L179703025	G-192	1 x Cj 1 x Pal	187,20 x Cj 187,20 x Pal
Noir	65x45x38cm 25 9/16"x17 3/4"x14 15/16"	100179789 L179703021	G-192	1 x Cj 1 x Pal	187,20 x Cj 187,20 x Pal

Qmax L/min=12 l/min (Pressure/Presión/Pression= 3 bar)



**VACIADOR FIJO TAPA
PIEDRA COMPATIBLE USA**
Included / Incluido / Inclus

Compatible with / *Compatible con* / *Compatible avec:*

USA SIFÓN PROJECT N
100209767 - N194710597
NOKEN

Saint Denis
Espejo Place

GLOSS

The set includes / *El conjunto incluye* /
L'ensemble comprend les éléments suivants:

-Mirrors / *Espejo* / *Miroir*
-Screws / *Tornillería* / *Visserie*
-Natural Stone hook / *Percha de piedra* / *Support en pierre*

Description	Format	Codes	Group	Pcs	Kg
Blanc	65x87x9cm 25 9/16"x34 1/4"x3 9/16"	100179749 L179703022	G-181	1 x Cj 1 x Pal	40,97 x Cj 40,97 x Pal
Noir	65x87x9cm 25 9/16"x34 1/4"x3 9/16"	100179765 L179703032	G-181	1 x Cj 1 x Pal	40,97 x Cj 40,97 x Pal

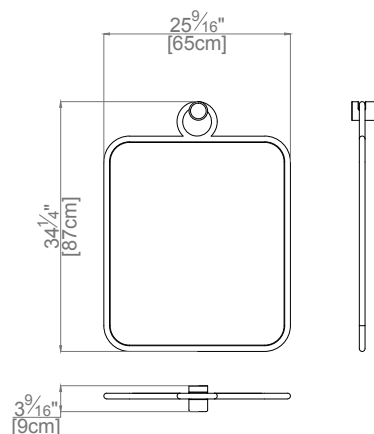

Saint Denis

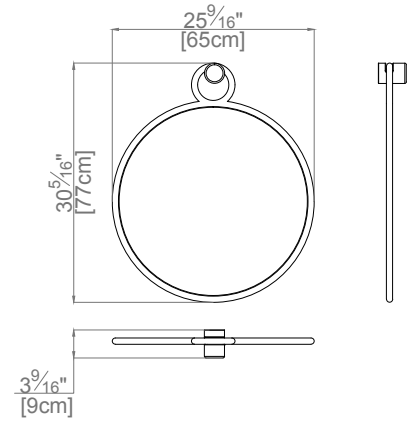

Bathrooms

Saint Denis Espejo Tour



The set includes / *El conjunto incluye /*
L'ensemble comprend les éléments suivants:

- Mirrors / *Espejo / Miroir*
- Screws / *Tornillería / Visserie*
- Natural Stone hook / *Percha de piedra / Support en pierre*

Description	Format	Codes	Group	Pcs	Kg
Blanc	65x77x9cm 21 5/8"x31 1/2"x1"	100179800 L179703029	G-181	1 x Cj 1 x Pal	36,26 x Cj 36,26 x Pal
Noir	65x77x9cm 21 5/8"x31 1/2"x1"	100179767 L179703030	G-181	1 x Cj 1 x Pal	36,26 x Cj 36,26 x Pal

Vintage

—
by Yonoh



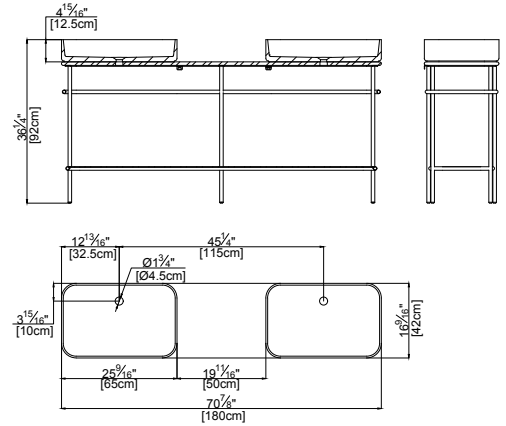

Vintage L



MATT



FREE-STANDING WASHBASIN



BIOPROT

The set includes / El conjunto incluye / L'ensemble comprend les éléments suivants:

- Wash basin / Lavabo / Lavabo
- Metal Structure / Estructura Metal / Structure métallique
- Stone countertop / Encimera de piedra / Plan de toilette en pierre
- Screws / Tornillería / Visserie
- Maintenance kit / Kit de mantenimiento / Kit d'entretien

Description	Format	Codes	Group	Pcs	Kg
Crema Italia / Blanco	180x42x92cm 70 7/8"x16 9/16"x36 1/4"	100185145 L179703159	G-194	1 x Cj 1 x Pal	153,37 x Cj 153,34 x Pal
Crema Italia / Negro	180x42x92cm 70 7/8"x16 9/16"x36 1/4"	100185654 L179703095	G-194	1 x Cj 1 x Pal	153,37 x Cj 153,34 x Pal
Habana Dark / Blanco	180x42x92cm 70 7/8"x16 9/16"x36 1/4"	100185163 L179703160	G-194	1 x Cj 1 x Pal	153,37 x Cj 153,34 x Pal
Habana Dark / Negro	180x42x92cm 70 7/8"x16 9/16"x36 1/4"	100185635 L179703096	G-194	1 x Cj 1 x Pal	153,37 x Cj 153,34 x Pal
Persian White / Blanco	180x42x92cm 70 7/8"x16 9/16"x36 1/4"	100185164 L179703126	G-194	1 x Cj 1 x Pal	153,37 x Cj 153,34 x Pal
Persian White / Negro	180x42x92cm 70 7/8"x16 9/16"x36 1/4"	100185672 L179703097	G-194	1 x Cj 1 x Pal	153,37 x Cj 153,34 x Pal



VACIADOR FIJO TAPA
PIEDRA COMPATIBLE USA

Included / Incluido / Inclus



Compatible with / Compatible con / Compatible avec:



USA SIFÓN PROJECT N
100209767 - N194710597
NOKEN



Qmax L/min=12 l/min (Pressure/Presión/Pression= 3 bar)

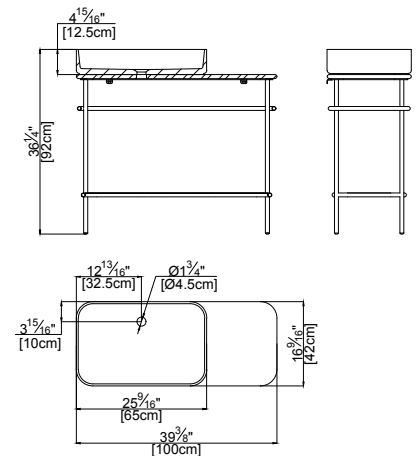

Vintage S



MATT



FREE-STANDING WASHBASIN



BIOPROT

The set includes / El conjunto incluye / L'ensemble comprend les éléments suivants:

- Wash basin / Lavabo / Lavabo
- Metal Structure / Estructura Metal / Structure métallique
- Stone countertop / Encimera de piedra / Plan de toilette en pierre
- Screws / Tornillería / Visserie
- Maintenance kit / Kit de mantenimiento / Kit d'entretien

Description	Format	Codes	Group	Pcs	Kg
Crema Italia / Blanco	100x42x91,5cm 39 3/8"x16 9/16"x36"	100185146 L179703161	G-188	1 x Cj 1 x Pal	84,28 x Cj 84,28 x Pal
Crema Italia / Negro	100x42x91,5cm 39 3/8"x16 9/16"x36"	100185636 L179703098	G-188	1 x Cj 1 x Pal	84,28 x Cj 84,28 x Pal
Habana Dark / Blanco	100x42x91,5cm 39 3/8"x16 9/16"x36"	100185156 L179703162	G-188	1 x Cj 1 x Pal	84,28 x Cj 84,28 x Pal
Habana Dark / Negro	100x42x91,5cm 39 3/8"x16 9/16"x36"	100185673 L179703094	G-188	1 x Cj 1 x Pal	84,28 x Cj 84,28 x Pal
Persian White / Blanco	100x42x91,5cm 39 3/8"x16 9/16"x36"	100185125 L179703125	G-188	1 x Cj 1 x Pal	84,28 x Cj 84,28 x Pal
Persian White / Negro	100x42x91,5cm 39 3/8"x16 9/16"x36"	100185662 L179703099	G-188	1 x Cj 1 x Pal	84,28 x Cj 84,28 x Pal



VACIADOR FIJO TAPA
PIEDRA COMPATIBLE USA

Included / Incluido / Inclus



Compatible with / Compatible con / Compatible avec:



USA SIFÓN PROJECT N
100209767 - N194710597
NOKEN



Qmax L/min=12 l/min (Pressure/Presión/Pression= 3 bar)

Vintage

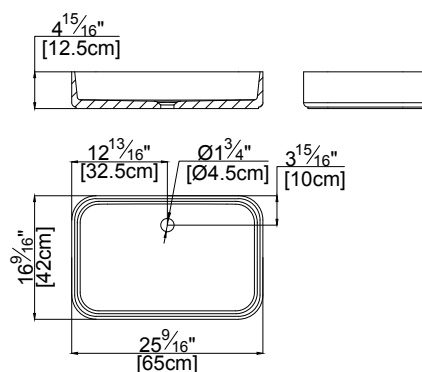

Vintage



The set includes / El conjunto incluye /
L'ensemble comprend les éléments suivants:

-Wash basin / Lavabo / Lavabo
-Maintenance kit / Kit de mantenimiento / Kit
d'entretien

Description	Format	Codes	Group	Pcs	Kg
Vintage Persian White	65x42x12,5cm 25 5/8"x16 2/4"x4 7/8"	100180582 L179703039	G-186	1 x Cj 1 x Pal	29,98 x Cj 29,98 x Pal
Vintage Crema Italia	65x42x12,5cm 25 5/8"x16 2/4"x4 7/8"	100180562 L179703037	G-186	1 x Cj 1 x Pal	29,98 x Cj 29,98 x Pal
Vintage Habana Dark	65x42x12,5cm 25 5/8"x16 2/4"x4 7/8"	100180581 L179703038	G-186	1 x Cj 1 x Pal	29,98 x Cj 29,98 x Pal

Qmax L/min=12 l/min (Pressure/Presión/Pression= 3 bar)



VACIADOR FIJO TAPA
PIEDRA COMPATIBLE USA



Compatible with / Compatible con / Compatible avec:



USA SIFÓN PROJECT N
100209767 - N194710597
NOKEN



Floor Coverings Habana Grey Pulido / Wall Coverings Habana Grey Classico, Airslate Forest / Complementary Products Vintage L Habana Dark-Negro, Espejo Vintage L Negro

02

Vintage

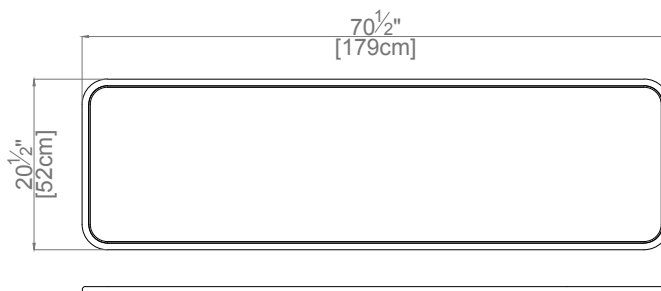

Vintage Espejo L



The set includes / *El conjunto incluye* /
L'ensemble comprend les éléments suivants:

-Mirrors / *Espejo* / *Miroir*
-Screws / *Tornillería* / *Visserie*

Description	Format	Codes	Group	Pcs	Kg
Blanco	179x52cm 70 1/2"x20 1/2"	100187395 L179703163	G-175	1 x Cj 10 x Pal	7,77 x Cj 77,76 x Pal
Negro	179x52cm 70 1/2"x20 1/2"	100187416 L179703164	G-175	1 x Cj 10 x Pal	7,77 x Cj 77,76 x Pal

Steam free mirror with built-in demister / *Espejo con Sistema Antivaho incorporado que evita que se empañe* / *Miroir avec système anti-buée intégré qui empêche que s'embue*

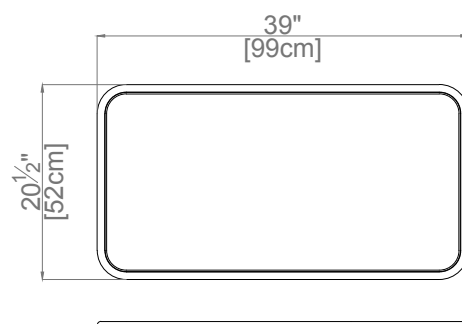

Vintage Espejo S



The set includes / *El conjunto incluye* /
L'ensemble comprend les éléments suivants:

-Mirrors / *Espejo* / *Miroir*
-Screws / *Tornillería* / *Visserie*

Description	Format	Codes	Group	Pcs	Kg
Blanco	99x52cm 39"x20 1/2"	100187396 L179703166	G-173	1 x Cj 10 x Pal	4,30 x Cj 43,01 x Pal
Negro	99x52cm 39"x20 1/2"	100187417 L179703165	G-173	1 x Cj 10 x Pal	4,30 x Cj 43,01 x Pal

Steam free mirror with built-in demister / *Espejo con Sistema Antivaho incorporado que evita que se empañe* / *Miroir avec système anti-buée intégré qui empêche que s'embue*



Tono

—
by Foster + Partners

Floor Coverings Advance 1L Marron / **Complementary Products** TONO Elements Habana Dark

The use of natural wood in baths shall be the responsibility of the client. / *El uso de la madera natural en baños es bajo la responsabilidad del cliente. / Il est de la responsabilité du client l'utilisation du bois naturel dans les bains*



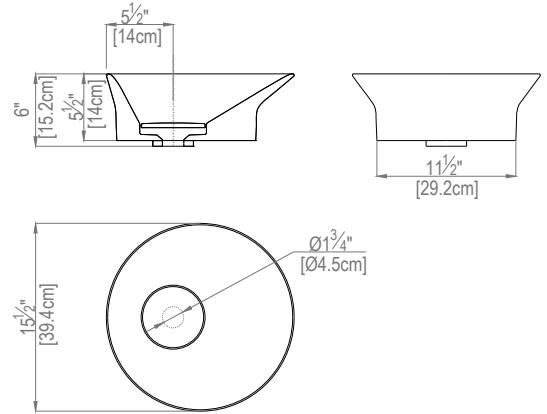

Stone Basin
Countertop 400
Angled



The set includes / El conjunto incluye /
L'ensemble comprend les éléments suivants:

-Wash basin / Lavabo / Lavabo
-Stone basin waste / Vaciador tapa piedra / Bonde de
vidage en pierre

Description	Format	Codes	Group	Pcs	Kg
Habana Dark Classico	39,4x39,4x15,2cm 15 1/2"x15 1/2"x6"	100200534 L179703289	G-186	1 x Cj 1 x Pal	47,11 x Cj 47,11 x Pal
Capuccino Grey Classico	39,4x39,4x15,2cm 15 1/2"x15 1/2"x6"	100200552 L179703287	G-185	1 x Cj 1 x Pal	47,11 x Pal 47,11 x Pal
Calgary Classico	39,4x39,4x15,2cm 15 1/2"x15 1/2"x6"	100200561 L179703288	G-185	1 x Cj 1 x Pal	47,11 x Pal 47,11 x Pal

Compatible with / Compatible con / Compatible avec:



**ADAPTADOR DESAGÜE
EUROPEA 6108099**
100040079 - N292009900
NOKEN



USA SIFÓN PROJECT N
100209767 - N194710597
NOKEN

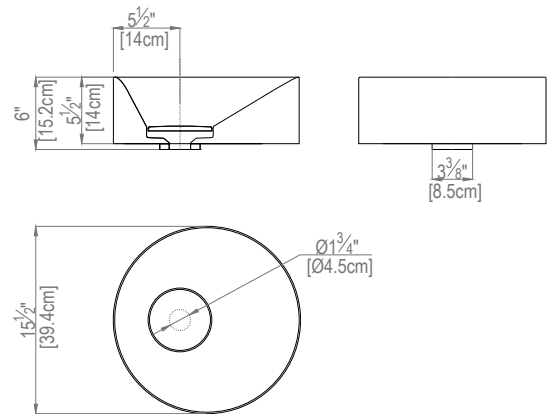

Stone Basin
Countertop 400
Straight



The set includes / El conjunto incluye /
L'ensemble comprend les éléments suivants:

-Wash basin / Lavabo / Lavabo
-Stone basin waste / Vaciador tapa piedra / Bonde de
vidage en pierre

Description	Format	Codes	Group	Pcs	Kg
Habana Dark Classico	39,4x39,4x15,2cm 15 1/2"x15 1/2"x6"	100200533 L179703286	G-186	1 x Cj 1 x Pal	47,11 x Cj 47,11 x Pal
Capuccino Grey Classico	39,4x39,4x15,2cm 15 1/2"x15 1/2"x6"	100200551 L179703285	G-185	1 x Cj 1 x Pal	47,11 x Pal 47,11 x Pal
Calgary Classico	39,4x39,4x15,2cm 15 1/2"x15 1/2"x6"	100200532 L179703284	G-185	1 x Cj 1 x Pal	47,11 x Pal 47,11 x Pal

Compatible with / Compatible con / Compatible avec:



**ADAPTADOR DESAGÜE
EUROPEA 6108099**
100040079 - N292009900
NOKEN



USA SIFÓN PROJECT N
100209767 - N194710597
NOKEN



Tono

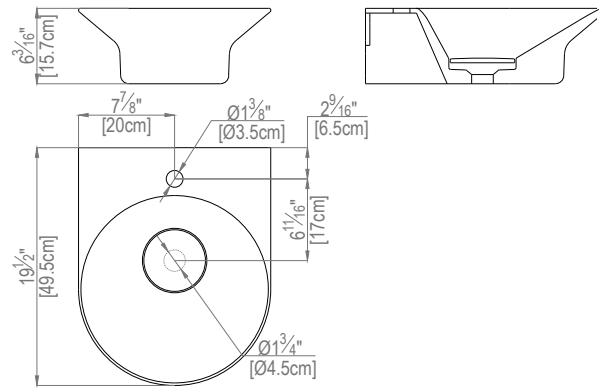

Bathrooms

Stone Basin Wall Mounted 400



The set includes / El conjunto incluye /
L'ensemble comprend les éléments suivants:

- Wash basin / Lavabo / Lavabo
- Stone basin waste / Vaciador tapa piedra / Bonde de vidage en pierre
- Bracket / Escuadra de sujeción / Équerre de fixation
- Screws / Tornillería / Visserie

Compatible with / Compatible con / Compatible avec:

Description	Format	Codes	Group	Pcs	Kg
Habana Dark Classico	49,5x40x15,7cm 19 1/2"x15 3/4"x6 3/16"	100200562 L179703292	G-192	1 x Cj 1 x Pal	64,30 x Cj 64,30 x Pal
Capuccino Grey Classico	49,5x40x15,7cm 19 1/2"x15 3/4"x6 3/16"	100200535 L179703291	G-190	1 x Cj 1 x Pal	64,30 x Cj 64,30 x Pal
Calgary Classico	49,5x40x15,7cm 19 1/2"x15 3/4"x6 3/16"	100200545 L179703290	G-190	1 x Cj 1 x Pal	64,30 x Cj 64,30 x Pal



**ADAPTADOR DESAGÜE
EUROPEA 6108099**
100040079 - N292009900
NOKEN



USA SIFÓN PROJECT N
100209767 - N194710597
NOKEN



Floor Coverings Patagonia Home / Wall Coverings Patagonia Home / Complementary Products Stone Basin Countertop 400 Angled Capuccino Grey Classico

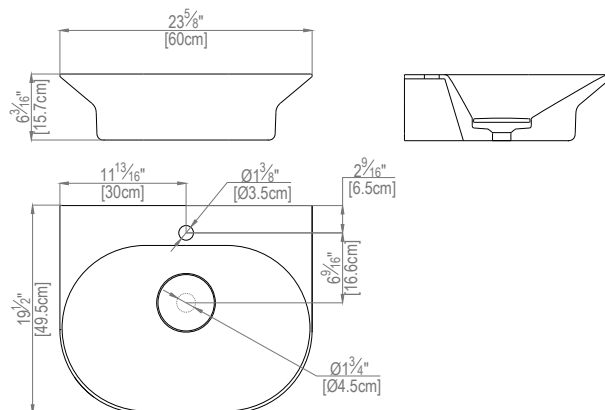

Stone Basin
Wall Mounted
600



The set includes / El conjunto incluye /
L'ensemble comprend les éléments suivants:

- Wash basin / Lavabo / Lavabo
- Stone basin waste / Vaciador tapa piedra / Bonde de vidage en pierre
- Bracket / Escuadra de sujeción / Équerre de fixation
- Screws / Tornillería / Visserie

Description	Format	Codes	Group	Pcs	Kg
Habana Dark Classico	49,5x60x15,7cm 19 1/2"x23 5/8"x6 3/16"	100200553 L179703295	G-194	1 x Cj 1 x Pal	94,79 x Cj 94,79 x Pal
Capuccino Grey Classico	49,5x60x15,7cm 19 1/2"x23 5/8"x6 3/16"	100200546 L179703294	G-193	1 x Cj 1 x Pal	94,79 x Cj 94,79 x Pal
Calgary Classico	49,5x60x15,7cm 19 1/2"x23 5/8"x6 3/16"	100200536 L179703293	G-193	1 x Cj 1 x Pal	94,79 x Cj 94,79 x Pal

Compatible with / Compatible con / Compatible avec:



**ADAPTADOR DESAGÜE
EUROPEA 6108099**
100040079 - N292009900
NOKEN



USA SIFÓN PROJECT N
100209767 - N194710597
NOKEN

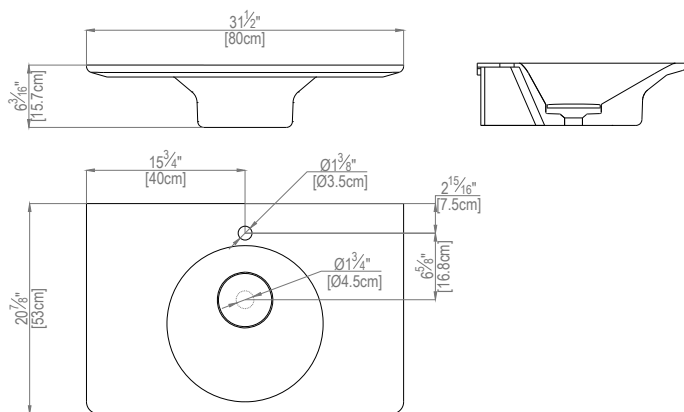

Stone Basin
Wall Mounted
800



The set includes / El conjunto incluye /
L'ensemble comprend les éléments suivants:

- Wash basin / Lavabo / Lavabo
- Stone basin waste / Vaciador tapa piedra / Bonde de vidage en pierre
- Bracket / Escuadra de sujeción / Équerre de fixation
- Screws / Tornillería / Visserie

Description	Format	Codes	Group	Pcs	Kg
Habana Dark Classico	53x80x15,7cm 20 7/8"x31 1/2"x6 3/16"	100200538 L108043751	G-195	1 x Cj 1 x Pal	132,91 x Cj 132,91 x Pal
Capuccino Grey Classico	53x80x15,7cm 20 7/8"x31 1/2"x6 3/16"	100200547 L108043741	G-194	1 x Cj 1 x Pal	132,91 x Cj 132,91 x Pal
Calgary Classico	53x80x15,7cm 20 7/8"x31 1/2"x6 3/16"	100200537 L108043731	G-194	1 x Cj 1 x Pal	132,91 x Cj 132,91 x Pal

Compatible with / Compatible con / Compatible avec:



**ADAPTADOR DESAGÜE
EUROPEA 6108099**
100040079 - N292009900
NOKEN



USA SIFÓN PROJECT N
100209767 - N194710597
NOKEN



Tono

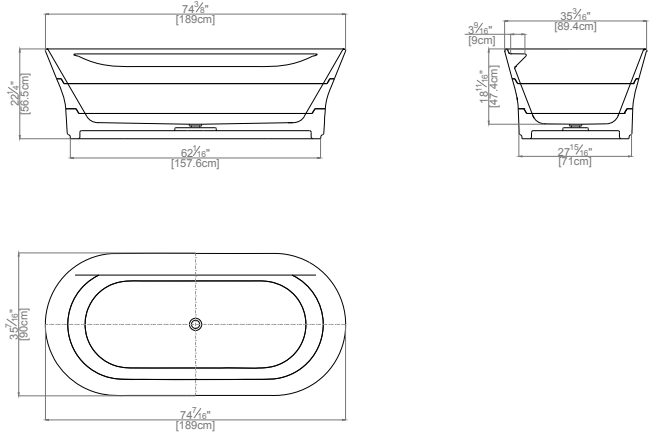

Stone Freestanding Bathtub



The set includes / El conjunto incluye / L'ensemble comprend les éléments suivants:

- Bathtub / Bañera / Baignoires
- Installation kit / Kit de instalación / Kit d'installation
- Gasket / Junta de montaje / Joint de montage
- Maintenance kit / Kit de mantenimiento / Kit d'entretien

Description	Format	Codes	Group	Pcs	Kg
Habana Dark Classico	90x189x56,5cm 35 7/16"x74 7/16"x22 1/4"	100200735 L173300511	G-197	1 x Cj 1 x Pal	630 x Cj 630 x Pal
Capuccino Grey Classico	90x189x56,5cm 35 7/16"x74 7/16"x22 1/4"	100200743 L173300510	G-197	1 x Cj 1 x Pal	630 x Cj 630 x Pal
Calgary Classico	90x189x56,5cm 35 7/16"x74 7/16"x22 1/4"	100200742 L173300509	G-197	1 x Cj 1 x Pal	630 x Cj 630 x Pal



VACIADOR PULSADOR CLIKER SIN REBOSADERO
100110743 - N698350001
NOKEN



STONE WASTE COVER EMBELLECEDOR PIEDRA ÉLÉMENT DÉCORATIF PIERRE
Hidden-drain pedestals are available on order in the same material and with the same finish as that used for the bathtubs. / Los embellecedores del desagüe pueden realizarse bajo pedido con el mismo material y acabado que la bañera. / Sur demande, les éléments décoratifs du drain peuvent être fabriqués dans le même matériel et avec les mêmes nitions que le baignoires. (See page / Ver página / Voir page 157)



Complementary Products Stone Basin Wall Mounted 600 Calgary Classico

02

Tono

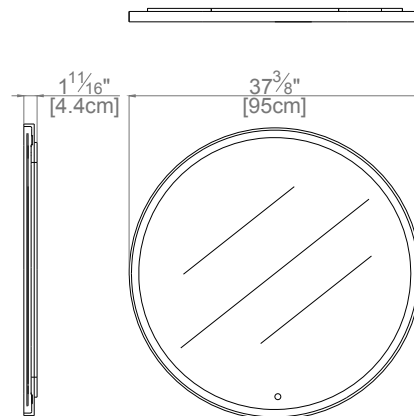

Stone Mirror D 950



The set includes / *El conjunto incluye* /
L'ensemble comprend les éléments suivants:

-Mirrors / *Espejo* / *Miroir*
-Screws / *Tornillería* / *Visserie*

Description	Format	Codes	Group	Pcs	Kg
Habana Dark Classico	95x95x4,4cm 37 3/8"x37 3/8"x1 11/16"	100200583 L179703307	G-192	1 x Cj 1 x Pal	21,07 x Cj 21,07 x Pal
Capuccino Grey Classico	95x95x4,4cm 37 3/8"x37 3/8"x1 11/16"	100200582 L179703306	G-190	1 x Cj 1 x Pal	21,07 x Cj 21,07 x Pal
Calgary Classico	95x95x4,4cm 37 3/8"x37 3/8"x1 11/16"	100200581 L179703305	G-190	1 x Cj 1 x Pal	21,07 x Cj 21,07 x Pal



Illuminated mirror fitted with LEDs on the perimeter / *Illuminado perimetralmente en los pliegues con LEDs* / *Périmètre éclairé au niveau des plis avec des LED*

Steam free mirror with built-in demister / *Espejo con Sistema Antivaho incorporado que evita que se empañe* / *Miroir avec système anti-buée intégré qui empêche que s'embue.*

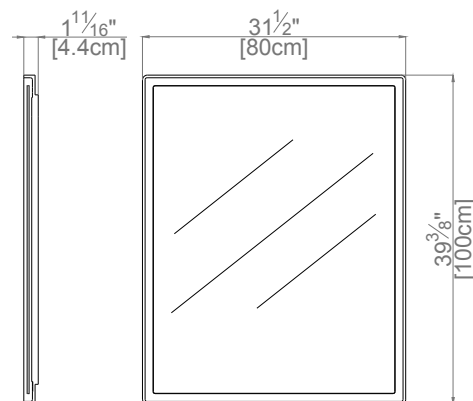

Stone Mirror 800x1000



The set includes / *El conjunto incluye* /
L'ensemble comprend les éléments suivants:

-Mirrors / *Espejo* / *Miroir*
-Screws / *Tornillería* / *Visserie*

Description	Format	Codes	Group	Pcs	Kg
Habana Dark Classico	80x100x4,4cm 31 1/2"x39 3/8"x1 11/16"	100200565 L179703304	G-190	1 x Cj 1 x Pal	25,76 x Cj 25,76 x Pal
Capuccino Grey Classico	80x100x4,4cm 31 1/2"x39 3/8"x1 11/16"	100200580 L179703303	G-189	1 x Cj 1 x Pal	25,76 x Cj 25,76 x Pal
Calgary Classico	80x100x4,4cm 31 1/2"x39 3/8"x1 11/16"	100200570 L179703302	G-189	1 x Cj 1 x Pal	25,76 x Cj 25,76 x Pal



Illuminated mirror fitted with LEDs on the perimeter / *Illuminado perimetralmente en los pliegues con LEDs* / *Périmètre éclairé au niveau des plis avec des LED*

Steam free mirror with built-in demister / *Espejo con Sistema Antivaho incorporado que evita que se empañe* / *Miroir avec système anti-buée intégré qui empêche que s'embue.*

Tono

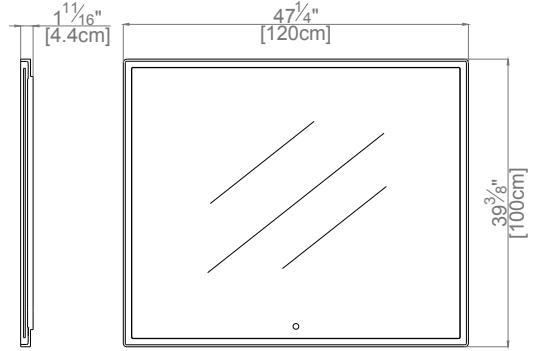

Stone Mirror 1200x1000



The set includes / El conjunto incluye /
L'ensemble comprend les éléments suivants:

-Mirrors / Espejo / Miroir
-Screws / Tornillería / Visserie

Description	Format	Codes	Group	Pcs	Kg
Habana Dark Classico	120x100x4,4cm 47 1/4"x39 3/8"x1 11/16"	100200539 L179703298	G-192	1 x Cj 1 x Pal	39,81 x Cj 39,81 x Pal
Capuccino Grey Classico	120x100x4,4cm 47 1/4"x39 3/8"x1 11/16"	100200564 L179703297	G-190	1 x Cj 1 x Pal	39,81 x Cj 39,81 x Pal
Calgary Classico	120x100x4,4cm 47 1/4"x39 3/8"x1 11/16"	100200563 L179703296	G-190	1 x Cj 1 x Pal	39,81 x Cj 39,81 x Pal



Illuminated mirror fitted with LEDs on the perimeter / Iluminado perimetralmente en los pliegues con LEDs / Périètre éclairé au niveau des plis avec des LED

Steam free mirror with built-in demister / Espejo con Sistema Antivaho incorporado que evita que se empañe / Miroir avec système anti-buée intégré qui empêche que s'embue.

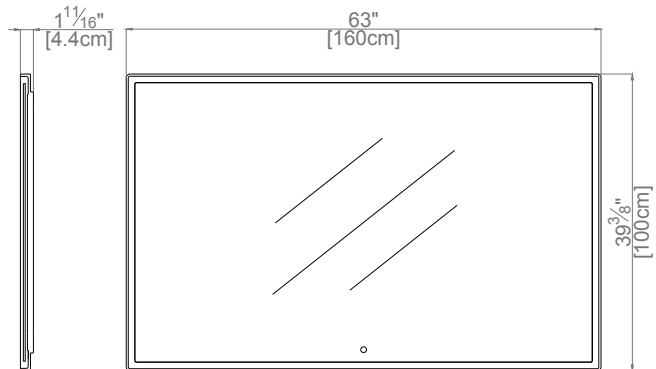

Stone Mirror 1600x1000



The set includes / El conjunto incluye /
L'ensemble comprend les éléments suivants:

-Mirrors / Espejo / Miroir
-Screws / Tornillería / Visserie

Description	Format	Codes	Group	Pcs	Kg
Habana Dark Classico	160x100x4,4cm 63"x39 3/8"x1 11/16"	100200549 L179703301	G-194	1 x Cj 1 x Pal	51,52 x Cj 51,52 x Pal
Capuccino Grey Classico	160x100x4,4cm 63"x39 3/8"x1 11/16"	100200548 L179703300	G-192	1 x Cj 1 x Pal	51,52 x Cj 51,52 x Pal
Calgary Classico	160x100x4,4cm 63"x39 3/8"x1 11/16"	100200554 L179703299	G-192	1 x Cj 1 x Pal	51,52 x Cj 51,52 x Pal



Illuminated mirror fitted with LEDs on the perimeter / Iluminado perimetralmente en los pliegues con LEDs / Périètre éclairé au niveau des plis avec des LED

Steam free mirror with built-in demister / Espejo con Sistema Antivaho incorporado que evita que se empañe / Miroir avec système anti-buée intégré qui empêche que s'embue.

Persian White



Bianco Almería



Grey Stone



Crema Italia



Beige



Habana Brown. Only Azrama Collection / Sólo colección Azrama

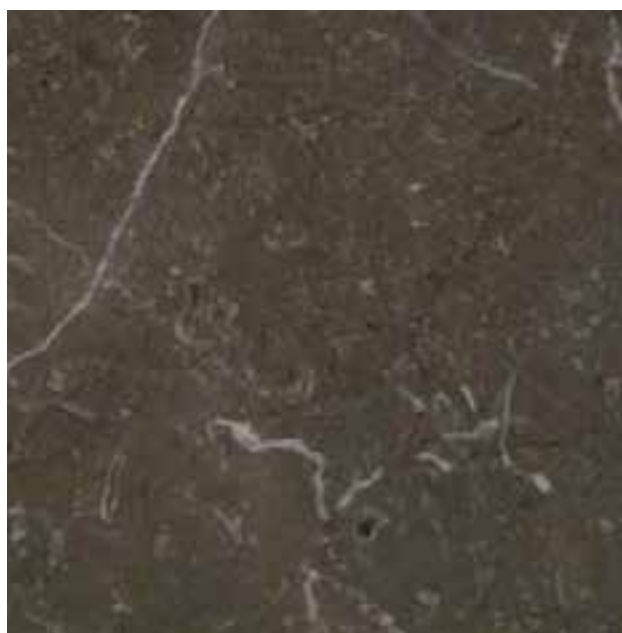

Finishes / Acabados / Acabados

Blanc. Only Saint Denis & Saint Germain Collection / Sólo colección Saint Denis y Saint Germain

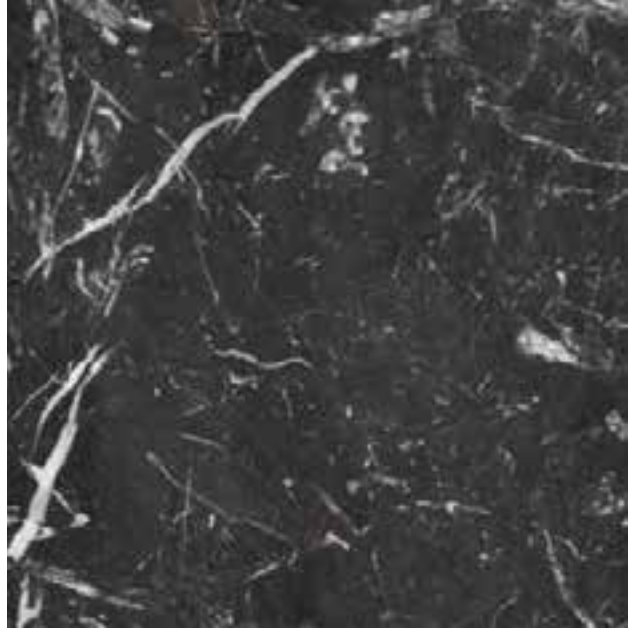

Noir. Only Saint Denis & Saint Germain Collection / Sólo colección Saint Denis y Saint Germain

A-cero Dark. Only Spirit Collection / Sólo colección Spirit



Habana Dark

A-cero Gloss / Calgary. Only Spirit & TONO Collection / Sólo colección Spirit y TONO



Capuccino Grey. Only TONO Collection / Sólo colección TONO

Pampa . Only worktops / Sólo para encimeras



Bhutan. Only worktops / Sólo para encimeras



Carrara. Only worktops / Sólo para encimeras



Patagonia. Only worktops / Sólo para encimeras



Tukuman. Only worktops / Sólo para encimeras

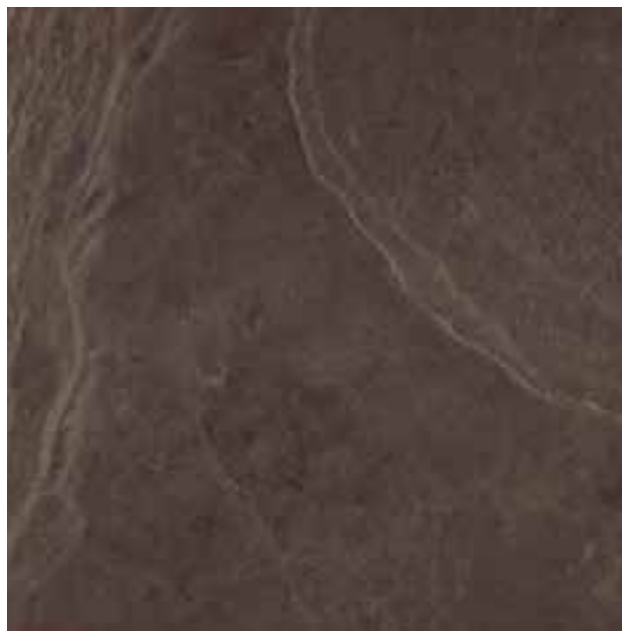

Finishes / Acabados / Acabados

Nogal Warm



Nogal Intense



Roble Sunset



Roble Cloudy



Roble Ceniza. Only Spirit Collection / Sólo colección Spirit



Roble Intenso. Only Spirit Collection / Sólo colección Spirit



Nogal Americano. Only Menhir Collection / Sólo colección Menhir



Roble Natural. Only Menhir Collection / Sólo colección Menhir



Roble Snow. Only Minim Wood Collection / Sólo colección Minim Wood



Roble Antracita. Only Menhir Collection / Sólo colección Menhir



Roble Beige. Only Minim Wood Collection / Sólo colección Minim Wood



Roble Grey. Only Minim Wood Collection / Sólo colección Minim Wood



Finishes / Acabados / Acabados

Roble Earth. Only Minim Wood Collection / Sólo colección Minim Wood



Iroko. Only Azrama Collection / Sólo colección Azrama



Bathrooms



Complementary Products Minim Wood Lavabo + Encimera Roble Earth - Habana Dark, Minim Espejo

WARRANTY

All our products are top quality and hold the guarantee obtained with the ISO 9001 certification and CE Marking, Declaration of Conformity. In addition, the department of quality at L'Antic Colonial, S.A conducts permanent quality controls of its products. All products are guaranteed against any production defects, in normal conditions of use and with correct assembly and installation for a period of TWO YEARS, from the delivery date to the first user. The goods should be carefully inspected on delivery. Any fault, defect or breakage observed, caused during transportation, should be recorded on the transport agency delivery note. In the case of units supplied in promotional offers, projects, etc., the guarantee period will start on the product supply date.

This guarantee does not apply to those products which have been stored, fitted or installed incorrectly, misused, or cleaned using unsuitable cleaning products or methods. This guarantee does not apply to those products that have been used for public use, outside or in corrosive environments.

The normal evolution and characteristics of the natural product are excluded. There may be slight differences of colour between the different elements and differences in tone or grain. In addition, if the products are compared at different moments, the time elapsed and the weather conditions may cause variations in colour and/or tone. While this guarantee remains valid, L'Antic Colonial reserves the right, without prior notification, to modify the technical and design specifications of its products.

Conditions of guarantee:

- That the product was purchased from an Official Distributor.
- That it has not been altered since it left the factory.
- That the recommendations for use and maintenance have been observed.
- That the products have not been used, or exhibited for an indefinite period in any showroom. The guarantee period for these articles is 30 days.

NOTE: The guarantee document is applicable without prejudice to the rights of the consumers established under the applicable Law in each country, and with that established under European Community legislation.

MAINTENANCE

Maintenance is essential for removing dirt or stains that may have built up, acid attacks, renewing the product shine, etc. Correct maintenance guarantees a longer life for the product.

NATURAL STONE

Ordinary cleaning: A neutral pH high-powered cleaner such as Fila Cleaner is recommended, to ensure fast and efficient cleaning, without damaging the product treatment. Dilute a capful of Fila Cleaner in a bucket of warm water and mop the product. Rinsing is not necessary. To remove stains or acid attacks: In the event of stains or attacks by acid substances (lemon, coke, tomato juice, lime scale removers, wine, vinegar, etc.) that react with the natural stone, these can be removed using a suitable restoration kit available from L'Antic Colonial points of sale. To remove organic stains, dyes and felt-tip pen, use the Fila Sr/95 colour stain remover.

Renewing or increasing the degree of shine: To renew or increase the degree of shine, use the specific natural wax, FilaClassic. To apply correctly, first dilute the product, apply to the surface and after a few hours, gently wipe with a soft cloth to obtain the required shine.

WOOD USED IN THE UNITS

Dust with a soft cloth at least twice a week. Units must never be exposed to prolonged contact with water or extremely high conditions of humidity.

Check that the bathroom is correctly ventilated. Wipe away any water spilt onto the surface, with a clean dry cloth as fast as possible to prevent moisture from penetrating into the product. Grease and oil stains can be easily removed with acetone.

Remember that to remove ordinary domestic dirt, abrasive soaps, steel wool, wax or polishers should not be used in the care and conservation of the product. A biodegradable cleaner that does not leave residue and does not require rinsing after application is ideal.

Avoid exposure to direct sunlight for prolonged periods of time. During the hours of maximum sunlight, use curtains or blinds to minimise the direct sunlight.

GLASS AND MIRRORS

Use a soft cloth moistened with alcohol. Avoid the use of abrasive materials that may harm or scratch the surface.

STAINLESS STEEL

Stainless steel is special steel known for its high resistance to knocks, scratches, light and corrosion. No special care is necessary but it is important not to use abrasive materials. Surfaces should be cleaned with a soft cloth and alcohol.

GARANTÍA

Todos nuestros productos son de primera calidad y cuentan con la garantía otorgada por la certificación ISO 9001 y la Declaración de conformidad relacionada con el Marcado CE. Así mismo, el departamento de calidad de L'Antic Colonial, S.A realiza un control permanente de la calidad de sus productos. Todos los productos están en garantía contra todo defecto de fabricación, en las condiciones normales de utilización y con un montaje e instalación correcto durante un periodo de DOS AÑOS, contando a partir de la fecha de entrega al primer usuario. Deberá ser revisada cuidadosamente la mercancía en el momento de la entrega. Toda anomalía, desperfecto o rotura detectada ocasionada en el transporte deberá ser anotada en el albarán de la agencia de transporte. En el caso de muebles suministrados en promociones, obras, etc..., el periodo de garantía contará a partir de la fecha de suministro de los mismos.

Esta garantía no se aplicará a aquellos productos que hayan sido almacenados, montados o instalados de forma incorrecta, o que se hayan utilizado de forma inapropiada, o que se hayan limpiado con métodos o productos de limpieza inadecuados. Esta garantía no se aplicará a aquellos productos que se hayan utilizado para uso público, en el exterior o en ambientes corrosivos.

Se excluyen de la garantía las características y evoluciones normales del producto natural, puede haber ligeras diferencias de tono entre los distintos elementos que lo componen y diferencias de matiz o veta. Además, si los productos se comparan en distintos momentos, el tiempo transcurrido y las condiciones climáticas pueden causar variaciones en color y/o tonalidad. Durante la vigencia de la presente garantía, L'Antic Colonial se reserva, sin previo aviso, la posibilidad de modificar las especificaciones técnicas y de diseño de sus productos.

Condiciones de garantía:

- Que el producto haya sido adquirido en un Distribuidor Oficial.
- Que no haya sido alterado desde su salida de fábrica.
- Que se hayan respetado todas las recomendaciones de uso y mantenimiento.
- Que los productos no hayan sido utilizados, ni hayan estado expuestos por tiempo indefinido en cualquier exposición, siendo el periodo de garantía de estos artículos de 30 días.

NOTA: El documento de garantía, será de aplicabilidad, sin perjuicio de los derechos de los consumidores establecidos por la Ley vigente en cada país, así como lo dispuesto en la normativa comunitaria europea.

MANTENIMIENTO

El mantenimiento tiene la importante finalidad de eliminar la suciedad, manchas que hayan podido penetrar ligeramente, ataques ácidos, renovar el brillo del material, etc. Un correcto mantenimiento garantiza una vida más larga al material.

PIEDRA NATURAL

Limpieza ordinaria: Se recomienda un limpiador con pH neutro y alto poder de limpieza como Fila Cleaner, así se garantiza una limpieza rápida y eficaz, respetando al mismo tiempo el tratamiento. Para ello se diluye un taponcito de Fila Cleaner en un cubo de agua tibia y luego se friega sin necesidad de aclarar.

Para eliminar manchas o ataques ácidos: En caso de que se formen manchas por ataques de sustancias ácidas (limón, cola, zumo de tomate, anticales, vino, vinagre, etc.) que reaccionan con la piedra natural, se pueden eliminar utilizando un kit de restauración adecuado disponibles en los puntos de venta de L'Antic Colonial. Para eliminar manchas orgánicas, tintes y rotuladores se recomienda utilizar el quitamanchas de color Fila Sr/95. Renovar o aumentar el grado de brillo: Para renovar o aumentar el grado de brillo existente, se recomienda utilizar la cera natural específica FilaClassic. Para una correcta aplicación se diluye previamente el producto, se aplica sobre la superficie y al cabo de unas horas se emplea con suavidad un paño para conseguir el brillo deseado.

MADERA DE LOS MUEBLES

Limpie el polvo con un paño suave por lo menos dos veces por semana. Los muebles no deben exponerse nunca a un contacto excesivo con agua o con una humedad extremadamente alta, por esta razón hay que asegurarse de que el baño cuenta con la ventilación adecuada. Si se derrama agua sobre la superficie, simplemente utilice un paño limpio y seco tan rápido como sea posible para evitar la penetración de la humedad. En cuanto a las manchas de grasa, estas se pueden eliminar fácilmente con acetona.

Debe tener en cuenta que la suciedad doméstica normal no deben utilizarse jabones abrasivos, estropajo de acero, cera o pulimentadora para su limpieza y conservación. Lo ideal es utilizar un limpiador biodegradable que no deje residuos y que no requiera enjuague después de la aplicación. Evite la exposición directa de luz solar durante periodos de tiempo prolongados. Durante las horas de máxima luz solar, utilice cortinas o persianas para minimizar la luz solar directa.

CRISTAL Y ESPEJOS

Utilizar un paño suave humedecido con alcohol. Evitar la utilización de materiales abrasivos que pueden incidir o rayar la superficie.

ACERO INOXIDABLE

El acero inoxidable es un acero especial que se distingue por su elevada resistencia a los golpes, a las rayaduras, a la luz y a la corrosión. No se requieren cuidados particulares pero es importante no utilizar materiales abrasivos. Se recomienda limpiar las superficies con un paño suave y alcohol.

Technical Information / Información Técnica / Informations Techniques

GARANTIE

Tous nos produits sont de première qualité et disposent de la garantie fournie par la certification ISO 9001 et la déclaration de conformité relative au marquage CE. De même, le département qualité de L'Antic Colonial, S.A réalise un contrôle permanent de la qualité de ses produits. Tous les produits sont garantis contre tout défaut de fabrication, dans les conditions normales d'utilisation et avec un montage et une installation correcte, pendant une période de DEUX ANS à partir de la date de livraison au premier utilisateur. La marchandise devra être vérifiée soigneusement au moment de la livraison. Toute anomalie, imperfection ou casse détectée et survenue pendant le transport devra apparaître sur le bon de livraison de l'agence de transport. Dans le cas de meubles fournis lors de promotions, sur chantier, etc., la période de garantie sera effective à partir de leur date de mise à disposition. Cette garantie ne s'appliquera pas aux produits stockés, montés ou installés de manière incorrecte, ou utilisés de manière inappropriée, ou nettoyés avec des méthodes ou des produits de nettoyage inadaptés.

Cette garantie ne s'appliquera pas aux produits utilisés pour une utilisation publique, en extérieur ou dans des environnements corrosifs. Sont exclues de la garantie les caractéristiques et évolutions normales du produit naturel ; les différents éléments le composant peuvent présenter de légères différences de ton, de nuance ou de veines. En outre, si les produits sont comparés à différents moments, le temps écoulé et les conditions climatiques peuvent provoquer des variations de couleur et/ou de tonalité. Pendant toute la période de validité de la présente garantie, L'Antic Colonial se réserve la possibilité, sans avertissement préalable, de modifier les spécifications techniques et de conception de ses produits.

Conditions de garantie:

- Le produit doit avoir été acheté auprès d'un distributeur officiel.
- Il ne doit pas avoir été modifié depuis sa sortie d'usine.
- Toutes les recommandations d'utilisation et d'entretien doivent avoir été respectées.

-Les produits ne doivent pas avoir été utilisés ou exposés pour une durée indéfinie à une quelconque exposition, la période de garantie de ces articles étant de 30 jours.

REMARQUE: Le document de garantie sera applicable, sans préjudice des droits aux consommateurs définis par la loi en vigueur dans chaque pays, comme le veut la réglementation communautaire européenne.

ENTRETIEN

L'entretien a pour finalité indispensable d'éliminer la saleté, les taches qui auraient pu pénétrer légèrement, les attaques acides, de renouveler la brillance du matériau, etc. Un entretien correct garantit une durée de vie accrue du matériau.

PIERRE NATURELLE

Nettoyage ordinaire: Un nettoyant au pH neutre et à haut pouvoir nettoyant, comme le Fila Cleaner, est recommandé afin de garantir un nettoyage rapide et efficace, tout en respectant le traitement. Diluer pour cela un bouchon de Fila Cleaner dans un seau d'eau tiède, puis laver sans rincer. Pour éliminer des taches ou attaques acides: Si des taches se forment sous l'effet de l'attaque de substances acides (citron, coca cola, jus de tomate, anticalcaire, vin, vinaigre, etc.) qui réagissent avec la pierre naturelle, il est possible de les éliminer en utilisant un kit de restauration adéquat, disponible dans les points de vente de L'Antic Colonial. Pour éliminer des taches organiques, de teinture et de feutres, il est recommandé d'utiliser l'anti-taches de couleur Fila Sr/95.

Renouveler ou accroître le niveau de brillance: Pour renouveler ou accroître le niveau de brillance existant, il est recommandé d'utiliser la cire naturelle spécifique FilaClassis. Pour une application correcte, diluer d'abord le produit, puis l'appliquer sur la surface et, après quelques heures, utiliser avec soin un chiffon pour obtenir la brillance souhaitée.

BOIS DES MEUBLES

Nettoyer la poussière avec un chiffon doux au moins deux fois par semaine. Les meubles ne doivent jamais être exposés à un contact excessif avec l'eau ou une humidité extrême ; c'est pourquoi il faut s'assurer que la salle de bain dispose d'une ventilation adéquate. Si de l'eau est renversée sur la surface, il suffit d'utiliser un chiffon propre et sec le plus rapidement possible pour éviter la pénétration de l'humidité. En ce qui concerne les taches de graisse, il est facile de les éliminer avec de l'acétone.

Il faut prendre en compte que dans le cas de la saleté domestique normale il n'est pas nécessaire d'utiliser des savons abrasifs, de la laine d'acier, de la cire ou une polisseuse pour leur nettoyage et conservation. L'idéal est d'utiliser un nettoyant biodégradable ne laissant aucun résidu et ne nécessitant aucun rinçage après application. Éviter l'exposition directe au soleil pendant des périodes prolongées. Pendant les heures d'ensoleillement maximal, utiliser des volets ou des rideaux pour réduire l'éclairage direct.

VERRE ET MIROIRS

Utiliser un chiffon doux humidifié avec de l'alcool. Éviter d'utiliser des matériaux abrasifs pouvant altérer ou rayer la surface.

ACIER INOXYDABLE

L'acier inoxydable est un acier spécial qui se distingue par sa résistance élevée aux chocs, aux rayures, à la lumière et à la corrosion.

Aucun soin particulier n'est recommandé mais il est important de ne pas utiliser de matériaux abrasifs. Il est recommandé de nettoyer les surfaces avec un chiffon doux et de l'alcool.



Complementary Products Minim Lavabo Persian White Classico

03

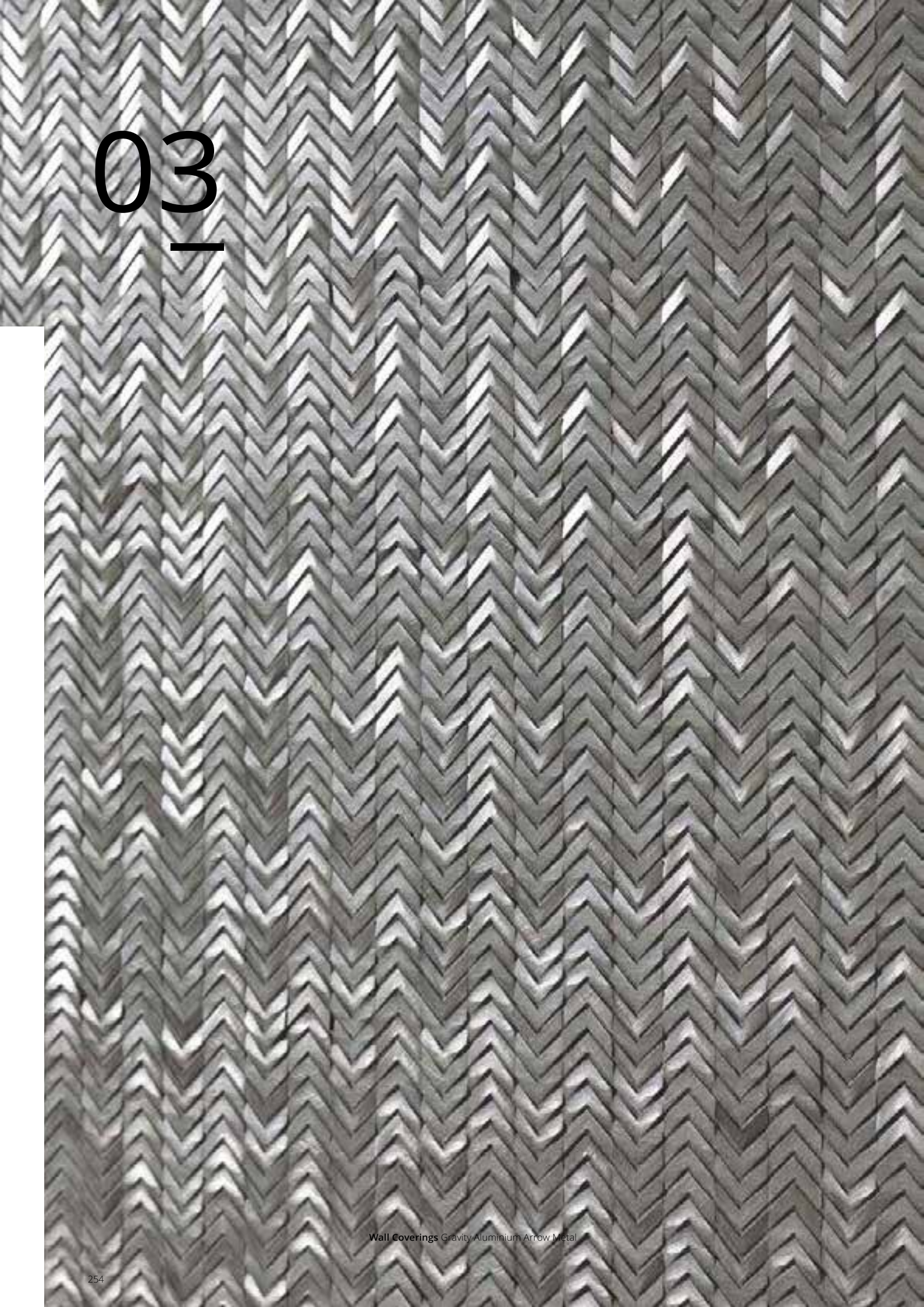

Mosaics

All L'Antic Colonial mosaics may be subject to variations in shade. The colour of the material supplied may differ slightly from that shown.

Our website (<http://anticcolonial.com/en/mosaics/>) contains further information in respect of our mosaics, such as installation guides and videos, technical specifications, details on textures or recommendations for use.

Todos los mosaicos de L'Antic Colonial pueden sufrir variaciones de tono. El color del material servido puede no ser exactamente igual al de la muestra.

En nuestra página web (<http://anticcolonial.com/mosaicos/>) encontrará información adicional de nuestros mosaicos como guías y vídeos de instalación, fichas técnicas, texturas o recomendaciones de uso.

Toutes les mosaïques de L'Antic Colonial peuvent subir des variations de tonalité. La couleur du matériau fourni peut être légèrement différente de celle de l'échantillon.

Sur notre site Internet (<http://anticcolonial.com/fr/mosaïques/>), vous trouverez des informations supplémentaires sur nos mosaïques : manuels et vidéos d'installations, fiches techniques, textures ou recommandations d'utilisation.

**MESHED**

Product manufactured on a mesh that makes installation easier.

ENMALLADO

Producto fabricado sobre una malla que facilita su instalación.

FILET

Produit fabriqué sur un filet qui facilite son installation.

**IRREGULAR TEXTURE**

Material that stands out for having an asymmetrical surface.

TEXTURA IRREGULAR

Material que destaca por tener una superficie asimétrica.

TEXTURE IRRÉGULIÈRE

Matériau qui se distingue par sa surface asymétrique.

**GLOSS**

Material with surface with the ability to produce reflections.

BRILLO

Material cuya superficie tiene la capacidad de producir reflejos.

ÉCLAT

Matériau dont la surface est en mesure de produire des reflets.

**MATT**

Material with a gloss-free surface.

MATE

Material cuya superficie carece de brillo.

MAT

Matériau dont la surface n'est pas brillante.

**INDOOR FLOORING**

Material suitable for use on indoor floors.

PAVIMENTO INTERIOR

Material apto para su uso en suelos de interior.

REVÊTEMENT DE SOL INTÉRIEUR

Matériau qui convient aux sols d'intérieur.

**INDOOR WALL COVERING**

Material suitable for use on indoor walls.

REVESTIMIENTO INTERIOR

Material apto para su uso en paredes de interior.

REVÊTEMENT INTÉRIEUR

Matériau qui convient aux murs d'intérieur.

**COUNTERTOPS**

Material suitable for use on countertops.

ENCIMERAS

Material apto para su uso en encimeras.

PLANS DE TRAVAIL/TOILETTE

Matériau qui convient aux plans de travail/toilette.

**OUTDOOR FLOORING**

Material suitable for use on outdoor floors.

PAVIMENTO EXTERIOR

Material apto para su uso en suelos de exterior.

REVÊTEMENT DE SOL EXTÉRIEUR

Matériau qui convient aux sols d'extérieur.

**OUTDOOR WALL COVERING**

Material suitable for use on outdoor walls.

REVESTIMIENTO EXTERIOR

Material apto para su uso en paredes de exterior.

REVÊTEMENT EXTÉRIEUR

Matériau qui convient aux murs d'extérieur.

**POOL SURROUNDINGS**

Material suitable for use on pool surroundings.

ALREDEDORES PISCINA

Material apto para su uso en zonas inmediaciones de piscinas.

ALENTOURS PISCINES

Matériau qui convient aux abords des piscines.

**SHOWER FLOORING**

Material suitable for use on shower floors.

PAVIMENTO DUCHAS

Material apto para su uso en suelos de ducha.

REVÊTEMENT DE SOL DOUCHES

Matériau qui convient aux sols de douche.

**SHOWER WALL COVERING**

Material suitable for use on shower walls.

REVESTIMIENTO DUCHAS

Material apto para su uso en paredes de ducha.

REVÊTEMENT DOUCHES

Matériau qui convient aux murs de douches.

**POOL**

Material suitable for use on permanently wet areas.

PISCINA

Material apto para su uso en zonas permanentemente húmedas.

PISCINE

Matériau qui convient aux zones toujours humides.



Stone Mosaics

—
World
Elite
Ancient
Lines
Essential
Outlines
Aichi
Moon
Paradise
Form
Skyline
Luxury
Magma
Constellation
Toscana
Weft
Universe

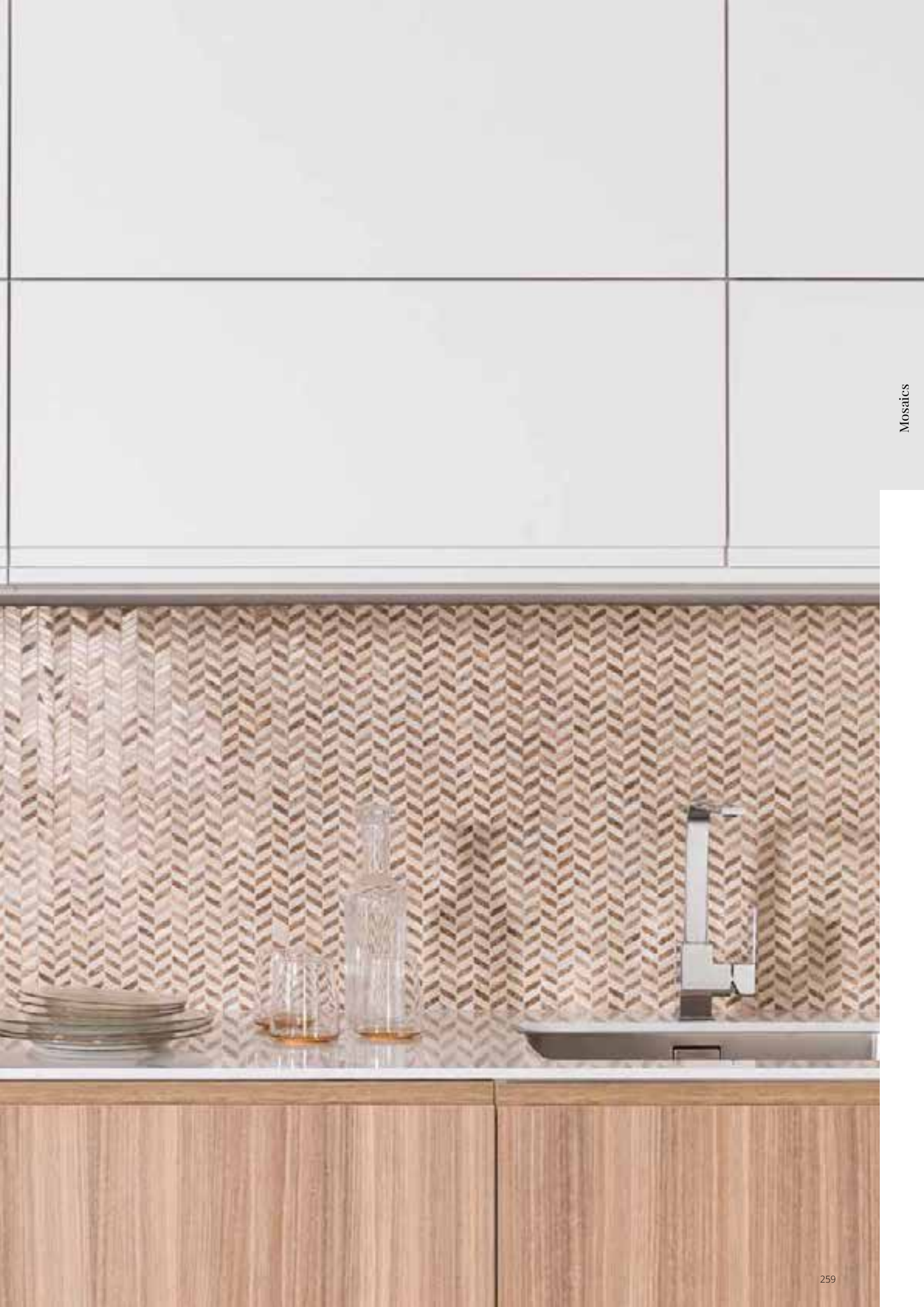



World Blanco Almeria
2x2cm - 3/4"x3/4"

29x29x1cm - 11 7/16"x11 7/16"x3/8"
100000559 - L119401501 - G-116



MARBLE / MÁRMOL / MARBRE

Butech: Colorstuk Rapid Blanco

Pcs	m2	Kg
10 x Cj 360 x Pal	0,84 x Cj 30,28 x Pal	18,84 x Cj 678,24 x Pal

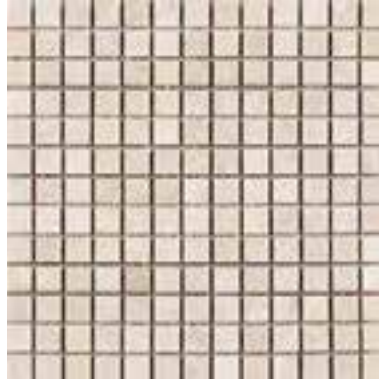

World Crema Italia
2x2cm - 3/4"x3/4"

29x29x1cm - 11 3/8"x11 3/8"x3/8"
100000560 - L119402501 - G-116



MARBLE / MÁRMOL / MARBRE

Butech: Colorstuk Rapid Marfil

Pcs	m2	Kg
10 x Cj 360 x Pal	0,84 x Cj 30,28 x Pal	15,33 x Cj 551,88 x Pal



World Beige
2x2cm - 3/4"x3/4"

29x29x1cm - 11 3/8"x11 3/8"x3/8"
100000561 - L119404501 - G-116



TRAVERTINE / TRAVERTINO / TRAVERTIN

Butech: Colorstuk Rapid Beige

Pcs	m2	Kg
10 x Cj 360 x Pal	0,73 x Cj 26,37 x Pal	19,78 x Cj 712,08 x Pal



World Random Shannan

30x30,5x1-1,2cm - 11 3/4"x12"x3/8"-1/2"
100153596 - L241710991 - G-110



QUARTZITE / CUARCITA / QUARTZITES

Butech: Colorstuk Rapid Manhattan

Pcs	m2	Kg
10 x Cj 540 x Pal	0,91 x Cj 49,41 x Pal	25 x Cj 1350 x Pal



World Random Nepal

30x30,5x1-1,2cm - 11 3/4"x12"x3/8"-1/2"
100153595 - L241711001 - G-110



SLATE / PIZARRA / ARDOISE

Butech: Colorstuk Rapid Manhattan

Pcs	m2	Kg
10 x Cj 480 x Pal	0,91 x Cj 49,41 x Pal	18 x Cj 972 x Pal



World Hexagon Text. Grey

30,5x26,5x0,8cm - 12"x10 3/8"x3/8"
100190437 - L241714531 - G-126

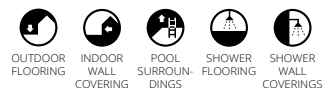

LIMESTONE / CALIZA / PIERRE CALCAIRE

Butech: Colorstuk Rapid Cemento

Pcs	m2	Kg
10 x Cj 480 x Pal	0,80 x Cj 38,79 x Pal	17,60 x Cj 844,80 x Pal

World



World Amsterdam Brick Grey

30x29,5x1cm - 11 3/4"x11 5/8"x3/8"
100173144 - L241713861 - G-133



LIMESTONE / CALIZA / PIERRE CALCAIRE

Butech: Colorstuk Rapid Gris

Pcs	m2	Kg
10 x Cj	0,89 x Cj	19,82 x Cj
360 x Pal	31,86 x Pal	713,52 x Pal



World Amsterdam Brick Beige

30x29,5x1cm - 11 3/4"x11 5/8"x3/8"
100173161 - L241713851 - G-133



LIMESTONE / CALIZA / PIERRE CALCAIRE

Butech: Colorstuk Rapid Beige

Pcs	m2	Kg
10 x Cj	0,89 x Cj	19,82 x Cj
360 x Pal	31,86 x Pal	713,52 x Pal



Wall Coverings World Amsterdam Brick Beige

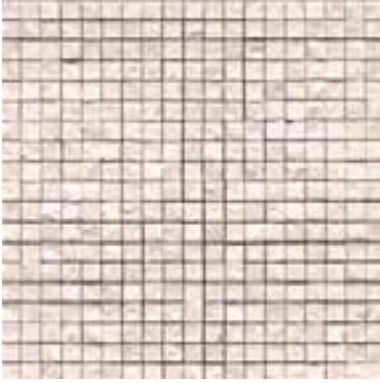

Elite Even Crema Grecia

1,5x1,5cm - 5/8"x5/8"

30x30x1cm - 11 3/4"x11 3/4"x3/8"

100153006 - L241710611 - G-146



MARBLE / MÁRMOL / MARBRE

No supported grouting / No admite rejuntado /
Ne peut pas être jointoyé.

Pcs	m2	Kg
10 x Cj	0,90 x Cj	15,44 x Cj
420 x Pal	37,80 x Pal	648,48 x Pal



Elite Even Burma

1,5x1,5cm - 5/8"x5/8"

30x30x1cm - 11 3/4"x11 3/4"x3/8"

100057244 - L108003031 - G-131



QUARTZITE / CUARCITA / QUARTZITES

No supported grouting / No admite rejuntado /
Ne peut pas être jointoyé.

Pcs	m2	Kg
10 x Cj	0,90 x Cj	16,14 x Cj
420 x Pal	37,80 x Pal	678 x Pal

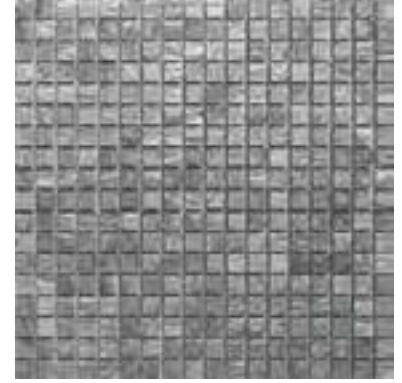

Elite Bhutan Silver

1,5x1,5cm - 5/8"x5/8"

30x30x1cm - 11 3/4"x11 3/4"x3/8"

100080871 - L108008561 - G-114



ENAMELED SLATE / PIZARRA ESMALTADA /
ARDOISE ÉMAILLÉ

Butech: Colorstuk Rapid Gris

Pcs	m2	Kg
11 x Cj	0,99 x Cj	17,22 x Cj
594 x Pal	53,46 x Pal	930 x Pal



Elite Bhutan Copper

1,5x1,5cm - 5/8"x5/8"

30x30x1cm - 11 3/4"x11 3/4"x3/8"

100080870 - L108008551 - G-114



ENAMELED SLATE / PIZARRA ESMALTADA /
ARDOISE ÉMAILLÉ

Butech: Colorstuk Rapid Beige

Pcs	m2	Kg
11 x Cj	0,99 x Cj	17,22 x Cj
594 x Pal	53,46 x Pal	930 x Pal



Elite Lava Stone Silver

1,4x1,4cm - 1/2"x1/2"

30x30x1,5cm - 11 3/4"x11 3/4"x5/8"

100161507 - L241712861 - G-146



BASALT / BASALTO / BASALTE
SCREEN PRINTED / SERIGRAFÍA / ÉCRAN

No supported grouting / No admite rejuntado /
Ne peut pas être jointoyé.

Pcs	m2	Kg
10 x Cj	0,9 x Cj	13,45 x Cj
600 x Pal	54 x Pal	807 x Pal



Elite Lava Stone Mix Gold Silver

1,4x1,4cm - 1/2"x1/2"

30x30x1,5cm - 11 3/4"x11 3/4"x5/8"

100161534 - L241712841 - G-146



BASALT / BASALTO / BASALTE
SCREEN PRINTED / SERIGRAFÍA / ÉCRAN

No supported grouting / No admite rejuntado /
Ne peut pas être jointoyé.

Pcs	m2	Kg
10 x Cj	0,9 x Cj	13,45 x Cj
600 x Pal	54 x Pal	807 x Pal

Elite



Elite Lava Stone Mix Gold White 1,4x1,4cm - 1/2"x1/2"

30,1x30,1x1,6cm - 11 7/8"x11 7/8"x5/8"
100172973 - L241713811 - G-146



BASALT / BASALTO / BASALTE
SCREEN PRINTED / SERIGRAFÍA / ÉCRAN

No supported grouting / No admite rejuntado /
Ne peut pas être jointoyé.

Pcs	m2	Kg
5 x Cj 240 x Pal	0,49 x Cj 23,27 x Pal	6,73 x Cj 322,80 x Pal

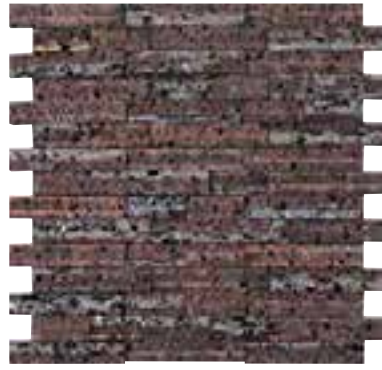

Elite Lava Stone Brick Silver

30,3x32x1,4cm - 11 7/8"x12 5/8"x1/2"
100172972 - L241713801 - G-146



BASALT / BASALTO / BASALTE
SCREEN PRINTED / SERIGRAFÍA / ÉCRAN

No supported grouting / No admite rejuntado /
Ne peut pas être jointoyé.

Pcs	m2	Kg
5 x Cj 240 x Pal	0,49 x Cj 23,27 x Pal	6,73 x Cj 322,80 x Pal

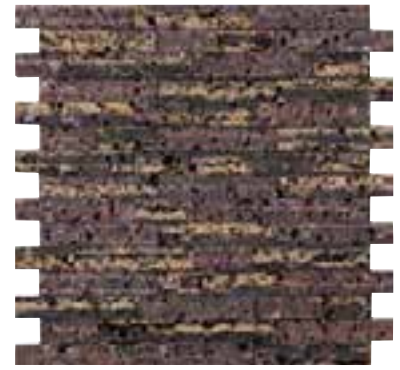

Elite Lava Stone Brick Gold

30,3x32x1,4cm - 11 7/8"x12 5/8"x1/2"
100172981 - L241713821 - G-146



BASALT / BASALTO / BASALTE
SCREEN PRINTED / SERIGRAFÍA / ÉCRAN

No supported grouting / No admite rejuntado /
Ne peut pas être jointoyé.

Pcs	m2	Kg
5 x Cj 240 x Pal	0,49 x Cj 23,27 x Pal	6,73 x Cj 322,80 x Pal



Elite Lava Stone Gold 1,4x1,4cm - 1/2"x1/2"

30x30x1,2cm - 11 3/4"x11 3/4"x1/2"
100190440 - L241714541 - G-146



BASALT / BASALTO / BASALTE
SCREEN PRINTED / SERIGRAFÍA / ÉCRAN

No supported grouting / No admite rejuntado /
Ne peut pas être jointoyé.

Pcs	m2	Kg
5 x Cj 240 x Pal	0,45 x Cj 21,60 x Pal	13,97 x Cj 670,80 x Pal



Wall Coverings Elite Lava Stone Brick Gold

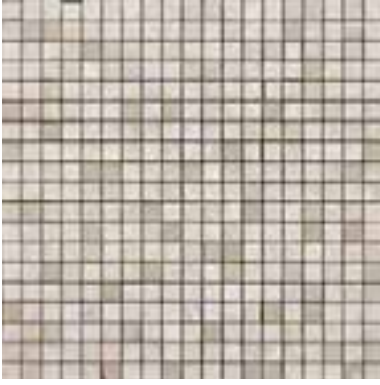

Elite Capuccino Texture -
Pul. 1,5x1,5cm - 5/8"x5/8"
 30x30x1cm - 11 3/4"x11 3/4"x3/8"
 100086096 - L108010101 - G-137

- IRREGULAR TEXTURE
- GLOSS
- MESHED
- POOL SURROUNDINGS
- SHOWER WALL COVERINGS
- OUTDOOR WALL COVERINGS
- INDOOR WALL COVERINGS
- INDOOR FLOORINGS
- OUTDOOR FLOORINGS
- SHOWER FLOORINGS

MARBLE / MÁRMOL / MARBRE

Butech: Colorstuk Rapid Beige

Pcs	m2	Kg
10 x Cj	0,90 x Cj	18,61 x Cj
360 x Pal	32,40 x Pal	670 x Pal



Elite Brick Creams
2,5x4,8cm - 1"x1 7/8"
 29x31,5x1,5cm - 11 3/8"x12 3/8"x5/8"
 100099430 - L119487381 - G-113

- IRREGULAR TEXTURE
- MATT
- MESHED
- INDOOR WALL COVERINGS

MARBLE / MÁRMOL / MARBRE

No supported grouting / No admite rejuntado /
 Ne peut pas être jointoyé.

Pcs	m2	Kg
7 x Cj	0,64 x Cj	16,30 x Cj
252 x Pal	23,02 x Pal	586,91 x Pal



Elite Brick Silver Wood
2,5x4,8cm - 1"x1 7/8"
 30x30x0,8cm - 11 3/4"x11 3/4"x3/8"
 100119813 - L241709051 - G-117

- IRREGULAR TEXTURE
- MATT
- MESHED
- INDOOR WALL COVERINGS

TRAVERTINE / TRAVERTINO / TRAVERTIN

No supported grouting / No admite rejuntado /
 Ne peut pas être jointoyé.

Pcs	m2	Kg
7 x Cj	0,63 x Cj	13,40 x Cj
336 x Pal	30,24 x Pal	643,10 x Pal



Elite Brick Whites
2,5x4,8cm - 1"x1 7/8"
 29x31,5x1,5cm - 11 3/8"x12 3/8"x5/8"
 100099431 - L119487391 - G-117

- IRREGULAR TEXTURE
- MATT
- MESHED
- INDOOR WALL COVERINGS

MARBLE / MÁRMOL / MARBRE

No supported grouting / No admite rejuntado /
 Ne peut pas être jointoyé.

Pcs	m2	Kg
7 x Cj	0,64 x Cj	16,30 x Cj
252 x Pal	23,02 x Pal	586,91 x Pal



Elite Brick Ariana
2,5x4,8cm - 1x1 7/8"
 29x31,5x1,5cm - 11 3/8"x12 3/8"x5/8"
 100100734 - L119487421 - G-111

- IRREGULAR TEXTURE
- MATT
- MESHED
- INDOOR WALL COVERINGS

MARBLE / MÁRMOL / MARBRE

No supported grouting / No admite rejuntado /
 Ne peut pas être jointoyé.

Pcs	m2	Kg
7 x Cj	0,64 x Cj	17,75 x Cj
252 x Pal	23,02 x Pal	639,07 x Pal

Ancient



Ancient Bath

2,3x2,3cm - 7/8"x7/8"

30,5x30,5x1cm - 12"x12"x3/8"

100113694 - L241707091 - G-156



MATT



MESHED



INDOOR
WALL
COVERINGS



SHOWER
WALL
COVERINGS

MARBLE / MÁRMOL / MARBRE

Butech: Colorstuk Rapid Beige

Pcs	m2	Kg
10 x Cj	0,93 x Cj	20,90 x Cj
420 x Pal	39,07 x Pal	842,94 x Pal



Ancient Earth

2,3x2,3cm - 7/8"x7/8"

30,5x30,5x1cm - 12"x12"x3/8"

100113696 - L241707001 - G-156



MATT



MESHED



INDOOR
WALL
COVERINGS



SHOWER
WALL
COVERINGS

MARBLE / MÁRMOL / MARBRE

Butech: Colorstuk Rapid Beige

Pcs	m2	Kg
10 x Cj	0,93 x Cj	21,32 x Cj
420 x Pal	39,07 x Pal	895,44 x Pal



Wall Coverings Ancient Earth



Lines Cambric Persian White Pulido

26,5x32,5x1cm - 10 3/8"x12 3/4"x3/8"
100173890 - L241713951 - G-133



MARBLE / MÁRMOL / MARBRE

Butech: Colorstuk 0-4 Blanco

Pcs	m2	Kg
10 x Cj 480 x Pal	1,11 x Cj 53,29 x Pal	14,69 x Cj 705,12 x Pal



Lines Cambric Persian White Classico

26,5x32,5x1cm - 10 3/8"x12 3/4"x3/8"
100173879 - L241713941 - G-133



MARBLE / MÁRMOL / MARBRE

Butech: Colorstuk 0-4 Blanco

Pcs	m2	Kg
10 x Cj 480 x Pal	1,11 x Cj 53,29 x Pal	14,69 x Cj 705,12 x Pal



Lines Cambric Silver Wood Pulido

26,5x32,5x1cm - 10 3/8"x12 3/4"x3/8"
100173869 - L241713961 - G-133



TRAVERTINE / TRAVERTINO / TRAVERTIN

Butech: Colorstuk 0-4 Gris

Pcs	m2	Kg
10 x Cj 480 x Pal	1,11 x Cj 53,29 x Pal	14,69 x Cj 705,12 x Pal



Lines Cambric Carrara Pulido

26,5x32,5x1cm - 10 3/8"x12 3/4"x3/8"
100213687 - L241715301 - G-135



MARBLE / MÁRMOL / MARBRE

Butech: Colorstuk 0-4 Blanco

Pcs	m2	Kg
10 x Cj 480 x Pal	0,86 x Cj 41,34 x Pal	15,20 x Cj 729,60 x Pal



Lines Mini Cambric Persian White Pulido

25,5x28x1cm - 10"x11"x3/8"
100161535 - L241712821 - G-133



MARBLE / MÁRMOL / MARBRE

Butech: Colorstuk 0-4 Blanco

Pcs	m2	Kg
10 x Cj 360 x Pal	0,71 x Cj 25,70 x Pal	11,38 x Cj 409,68 x Pal



Lines Mini Cambric Persian White Classico

25,5x28x1cm - 10"x11"x3/8"
100161517 - L241712831 - G-133



MARBLE / MÁRMOL / MARBRE

Butech: Colorstuk 0-4 Blanco

Pcs	m2	Kg
10 x Cj 360 x Pal	0,71 x Cj 25,70 x Pal	11,38 x Cj 409,68 x Pal

Lines



Lines Cambric Silver Wood Classico

26,5x32,5x1cm - 10 3/8"x12 3/4"x3/8"
100173881 - L241713931 - G-133



TRAVERTINE / TRAVERTINO / TRAVERTIN

Butech: Colorstuk 0-4 Gris

Pcs	m2	Kg
10 x Cj	1,11 x Cj	14,69 x Cj
480 x Pal	53,29 x Pal	705,12 x Pal



Lines Mini Cambric Silver Wood Pulido

25,5x28x1cm - 10"x11"x3/8"
100161519 - L241712811 - G-133



TRAVERTINE / TRAVERTINO / TRAVERTIN

Butech: Colorstuk 0-4 Gris

Pcs	m2	Kg
10 x Cj	0,71 x Cj	11,38 x Cj
360 x Pal	25,70 x Pal	409,68 x Pal



Lines Mini Cambric Silver Wood Classico

25,5x28x1cm - 10"x11"x3/8"
100161518 - L241712851 - G-133



TRAVERTINE / TRAVERTINO / TRAVERTIN

Butech: Colorstuk 0-4 Gris

Pcs	m2	Kg
10 x Cj	0,71 x Cj	11,38 x Cj
360 x Pal	25,70 x Pal	409,68 x Pal



Lines Silver Wood Grey

31x31x1cm - 12 1/4"x12 1/4"x3/8"
100110504 - L101200001 - G-136



TRAVERTINE / TRAVERTINO / TRAVERTIN

Butech: Colorstuk 0-4 Gris

Pcs	m2	Kg
10 x Cj	0,96 x Cj	23,10 x Cj
360 x Pal	34,56 x Pal	831,60 x Pal



Lines Safary Brown

30,4x29,8x1cm - 12"x11 3/4"x3/8"
100103960 - L153801151 - G-151



TRAVERTINE / TRAVERTINO / TRAVERTIN

Butech: Colorstuk 0-4 Gris

Pcs	m2	Kg
10 x Cj	0,91 x Cj	22,05 x Cj
360 x Pal	32,61 x Pal	793,80 x Pal



Lines Safary White

30,4x29,8x1cm - 12"x11 3/4"x3/8"
100103959 - L153801161 - G-151



MARBLE / MÁRMOL / MARBRE

Butech: Colorstuk 0-4 Blanco

Pcs	m2	Kg
10 x Cj	0,91 x Cj	22,05 x Cj
360 x Pal	32,61 x Pal	793,80 x Pal



Essential Chess Thassos

30,6x30,6x1cm - 12"x12"x3/8"
100115762 - L241708001 - G-150



MARBLE / MÁRMOL / MARBRE

Butech: Colorstuk 0-4 Blanco

Pcs	m2	Kg
10 x Cj	0,93 x Cj	22,77 x Cj
360 x Pal	33,69 x Pal	819,72 x Pal



Essential Chess Silver Wood

30,6x30,6x1cm - 12"x12"x3/8"
100115761 - L241708101 - G-146



TRAVERTINE / TRAVERTINO / TRAVERTIN

Butech: Colorstuk 0-4 Gris

Pcs	m2	Kg
10 x Cj	0,93 x Cj	22,77 x Cj
360 x Pal	33,69 x Pal	819,72 x Pal



Essential Stripes Silver Wood

30,5x30,5x1cm - 12"x12"x3/8"
100115765 - L241708041 - G-150



TRAVERTINE / TRAVERTINO / TRAVERTIN

Butech: Colorstuk 0-4 Gris

Pcs	m2	Kg
10 x Cj	0,93 x Cj	22,66 x Cj
360 x Pal	33,48 x Pal	815,76 x Pal



Essential Basket Thassos

28,7x28,7x1cm - 11 1/4"x11 1/4"x3/8"
100115760 - L241708071 - G-146



MARBLE / MÁRMOL / MARBRE

Butech: Colorstuk 0-4 Blanco

Pcs	m2	Kg
10 x Cj	0,82 x Cj	20,07 x Cj
360 x Pal	29,63 x Pal	722,52 x Pal



Essential Flag Thassos

30,2x32,2x1cm - 11 7/8"x12 5/8"x3/8"
100115764 - L241708091 - G-156



MARBLE / MÁRMOL / MARBRE

Butech: Colorstuk 0-4 Blanco

Pcs	m2	Kg
10 x Cj	0,97 x Cj	23,70 x Cj
360 x Pal	34,99 x Pal	853,20 x Pal



Essential Mini Brick Persian White

28x30x1cm - 11"x11 3/4"x3/8"
100179706 - L241714391 - G-130



MARBLE / MÁRMOL / MARBRE

Butech: Colorstuk 0-4 Blanco

Pcs	m2	Kg
10 x Cj	0,84 x Cj	17,01 x Cj
360 x Pal	30,24 x Pal	612,36 x Pal

Essential



Essential Hexagon Persian White

25,8x29,8x1cm - 10 1/8"x11 3/4"x3/8"
100188562 - L241714511 - G-135



MARBLE / MÁRMOL / MARBRE

Butech: Colorstuk 0-4 Blanco

Pcs	m2	Kg
10 x Cj 360 x Pal	0,77 x Cj 27,68 x Pal	18,40 x Cj 662,40 x Pal



Essential Hexagon Carrara Pulido

25,8x29,8x1cm - 10 1/8"x11 3/4"x3/8"
100213685 - L241715261 - G-137



MARBLE / MÁRMOL / MARBRE

Butech: Colorstuk 0-4 Blanco

Pcs	m2	Kg
10 x Cj 360 x Pal	0,77 x Cj 27,68 x Pal	19,04 x Cj 685,44 x Pal



Essential Hexagon Silver Wood

25,8x29,8x1cm - 10 1/8"x11 3/4"x3/8"
100189456 - L241714521 - G-135



TRAVERTINE / TRAVERTINO / TRAVERTIN

Butech: Colorstuk 0-4 Gris

Pcs	m2	Kg
10 x Cj 360 x Pal	0,77 x Cj 27,68 x Pal	16,56 x Cj 596,16 x Pal



Essential Mini Brick Silver Wood

28x30x1cm - 11"x11 3/4"x3/8"
100179704 - L241714381 - G-140



TRAVERTINE / TRAVERTINO / TRAVERTIN

Butech: Colorstuk 0-4 Gris

Pcs	m2	Kg
10 x Cj 360 x Pal	0,84 x Cj 30,24 x Pal	17,01 x Cj 612,36 x Pal

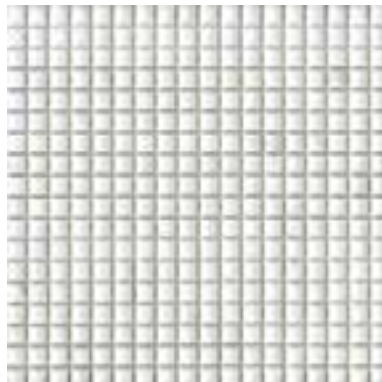

Essential Diamond Persian White

30,5x30,5x0,8cm - 12"x12"x3/8"
100203124 - L241714781 - G-139



MARBLE / MÁRMOL / MARBRE

Butech: Colorstuk 0-4 Blanco

Pcs	m2	Kg
11 x Cj 528 x Pal	1,02 x Cj 49,11 x Pal	14,11 x Cj 677,42 x Pal



Essential Diamond Silver Wood

30,5x30,5x0,8cm - 12"x12"x3/8"
100203095 - L241714791 - G-139



TRAVERTINE / TRAVERTINO / TRAVERTIN

Butech: Colorstuk 0-4 Gris

Pcs	m2	Kg
11 x Cj 528 x Pal	1,02 x Cj 49,11 x Pal	14,11 x Cj 677,42 x Pal



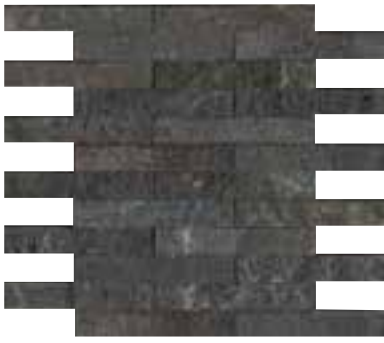

Outlines Brick Burma
2,5x15cm - 1"x5 7/8"

31x30x1cm - 12 1/4"x11 3/4"x3/8"
100031996 - L108000341 - G-119



SLATE / PIZARRA / ARDOISE

No supported grouting / No admite rejuntado /
Ne peut pas être jointoyé.

Pcs	m2	Kg
10 x Cj 360 x Pal	0,93 x Cj 33,48 x Pal	23,45 x Cj 844,20 x Pal

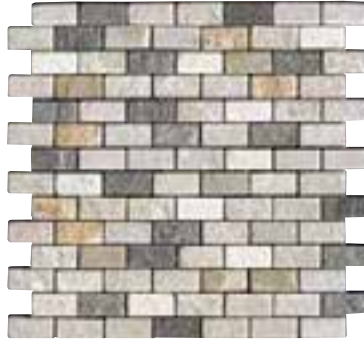

**Outlines Brick Lhasa-Sha.-
Burma 2x4cm - 1"x2"**

30,2x30,2x1cm - 11 7/8"x11 7/8"x3/8"
100001603 - L154101501 - G-126



SLATE / PIZARRA / ARDOISE
QUARTZITE / CUARCITA / QUARTZITE

Butech: Colorstuk Rapid Gris

Pcs	m2	Kg
10 x Cj 360 x Pal	0,91 x Cj 32,73 x Pal	23,45 x Cj 844,20 x Pal



Outlines Bars Capuccino
Lin. Hom.

32,3x20x1cm - 12 3/4"x7 7/8"x3/8"
100097588 - L108015711 - G-119



MARBLE / MÁRMOL / MARBRE

Butech: Colorstuk Rapid Beige

Pcs	m2	Kg
5 x Cj 300 x Pal	0,32 x Cj 19,26 x Pal	8,08 x Cj 484,50 x Pal



Outlines Bars Hab. Brown
Lin. Hom.

32,3x20x1cm - 12 3/4"x7 7/8"x3/8"
100097592 - L108015691 - G-119



MARBLE / MÁRMOL / MARBRE

Butech: Colorstuk Rapid Manhattan

Pcs	m2	Kg
5 x Cj 300 x Pal	0,32 x Cj 19,26 x Pal	8,08 x Cj 484,50 x Pal



Outlines Mini Strip Bhutan

29,9x22,7x1cm - 11 3/4"x8 7/8"x3/8"
100062964 - L108005211 - G-119



SLATE / PIZARRA / ARDOISE

Butech: Colorstuk Rapid Antracita

Pcs	m2	Kg
10 x Cj 360 x Pal	0,68 x Cj 24,48 x Pal	15,53 x Cj 559,08 x Pal



Outlines Mini Strip Nepal

29,9x22,7x1cm - 11 3/4"x8 7/8"x3/8"
100062965 - L108005231 - G-119



SLATE / PIZARRA / ARDOISE

Butech: Colorstuk Rapid Manhattan

Pcs	m2	Kg
10 x Cj 360 x Pal	0,68 x Cj 24,48 x Pal	15,53 x Cj 559,08 x Pal

Outlines



Outlines Mini Strip Shannan

29,9x22,7x1cm - 11 3/4"x8 7/8"x3/8"
100062966 - L108005221 - G-119



QUARTZITE / CUARCITA / QUARTZITE

Butech: Colorstuk Rapid Marfil

Pcs	m2	Kg
10 x Cj 360 x Pal	0,68 x Cj 24,48 x Pal	15,53 x Cj 559,08 x Pal



Outlines Mini Strip Canyon

29,9x22,7x1cm - 11 3/4"x8 7/8"x3/8"
100103947 - L108017171 - G-136



QUARTZITE / CUARCITA / QUARTZITE

Butech: Colorstuk Rapid Blanco

Pcs	m2	Kg
10 x Cj 360 x Pal	0,68 x Cj 24,52 x Pal	16,56 x Cj 596,16 x Pal



Wall Coverings Outlines Mini Strip Canyon

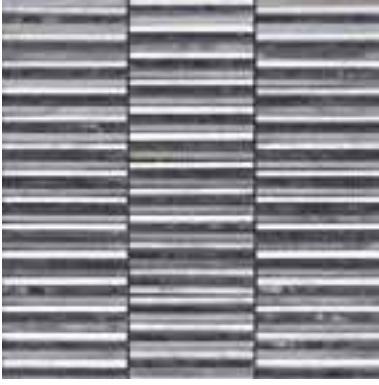

Aichi Greys

0,5x10cm - 1/4"x3 7/8"

29,8x30,5x1cm - 11 3/4"x12"x3/8"

100057249 - L108003011 - G-138



MARBLE / MÁRMOL / MARBRE

Butech: Colorstuk Rapid Gris

Pcs	m2	Kg
5 x Cj	0,45 x Cj	9,48 x Cj
360 x Pal	32,40 x Pal	708,12 x Pal

Aichi Browns

0,5x10cm - 1/4"x3 7/8"

29,8x30,5x1cm - 11 3/4"x12"x3/8"

100001555 - L150901001 - G-138



MARBLE / MÁRMOL / MARBRE

Butech: Colorstuk Rapid Gris

Pcs	m2	Kg
5 x Cj	0,45 x Cj	10,21 x Cj
360 x Pal	32,40 x Pal	735 x Pal

Aichi Mix Wood

0,5x10cm - 1/4"x3 7/8"

29,8x29,8x1cm - 11 3/4"x11 3/4" x3/8"

100115754 - L241708021 - G-138



TRAVERTINE / TRAVERTINO / TRAVERTIN

Butech: Colorstuk Rapid Gris

Pcs	m2	Kg
5 x Cj	0,45 x Cj	10,82 x Cj
360 x Pal	32,72 x Pal	778,68 x Pal



Wall Coverings Aichi Greys

Moon



Moon Marmara

19x29x1cm - 7 7/8"x7 7/8"x3/8"
100153030 - L241710631 - G-130



MARBLE / MÁRMOL / MARBRE

Butech: Colorstuk Rapid Blanco

Pcs	m2	Kg
10 x Cj	0,55 x Cj	11,65 x Cj
680 x Pal	37,46 x Pal	792,20 x Pal

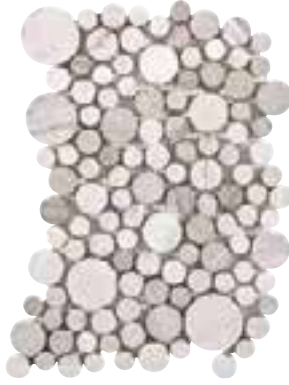

Moon Silver Wood

19x29x1cm - 7 7/8"x7 7/8"x3/8"
100115838 - L241708141 - G-117



TRAVERTINE / TRAVERTINO / TRAVERTIN

Butech: Colorstuk Rapid Gris

Pcs	m2	Kg
12 x Cj	0,66 x Cj	11,54 x Cj
720 x Pal	39,67 x Pal	692,64 x Pal



Moon Mix Browns

19x29x1cm - 7 7/8"x7 7/8"x3/8"
100079200 - L108007911 - G-119



MARBLE / MÁRMOL / MARBRE

Butech: Colorstuk Rapid Beige

Pcs	m2	Kg
5 x Cj	0,28 x Cj	5,75 x Cj
540 x Pal	29,75 x Pal	621 x Pal



Wall Coverings Moon Silver Wood



Paradise Baia Stone Negro

30x30x1cm - 11 3/4"x11 3/4"x3/8"
100001572 - L152901011 - G-110

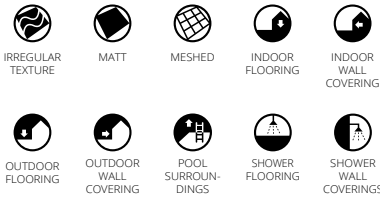

BASALT / BASALTO / BASALTE

Butech: Colorstuk Rapid Antracita

Pcs	m2	Kg
10 x Cj 360 x Pal	0,90 x Cj 32,40 x Pal	23,80 x Cj 856,80 x Pal



Paradise Baia Stone Blanco

30x30x1cm - 11 3/4"x11 3/4"x3/8"
100001571 - L152901001 - G-110

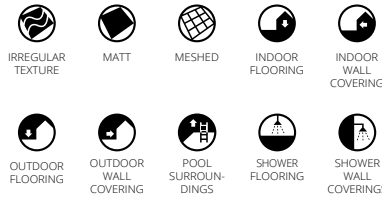

MARBLE / MÁRMOL / MARBRE

Butech: Colorstuk Rapid Blanco

Pcs	m2	Kg
10 x Cj 360 x Pal	0,90 x Cj 32,40 x Pal	23,80 x Cj 856,80 x Pal

STOCK



Paradise Baia Stone Cremas

30x30x1cm - 11 3/4"x11 3/4"x3/8"
100068033 - L108006581 - G-110

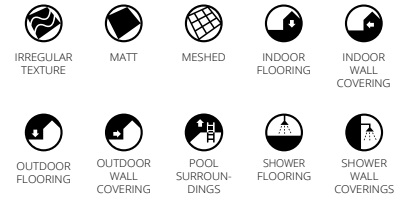

MARBLE / MÁRMOL / MARBRE

Butech: Colorstuk Rapid Beige

Pcs	m2	Kg
10 x Cj 360 x Pal	0,90 x Cj 32,40 x Pal	23,80 x Cj 856,80 x Pal



Paradise Lake Stone Negro

30x30x1cm - 11 3/4"x11 3/4"x3/8"
100062502 - L159001521 - G-110



BASALT / BASALTO / BASALTE

Butech: Colorstuk Rapid Antracita

Pcs	m2	Kg
9 x Cj 486 x Pal	0,81 x Cj 43,74 x Pal	17,05 x Cj 920,48 x Pal



Paradise Lake Stone Blanco

30x30x1cm - 11 3/4"x11 3/4"x3/8"
100062501 - L159001531 - G-110



MARBLE / MÁRMOL / MARBRE

Butech: Colorstuk Rapid Marfil

Pcs	m2	Kg
9 x Cj 486 x Pal	0,81 x Cj 43,74 x Pal	17,05 x Cj 920,48 x Pal

STOCK



Paradise Lake Stone Cremas

30x30x1cm - 11 3/4"x11 3/4"x3/8"
100082709 - L108008991 - G-110

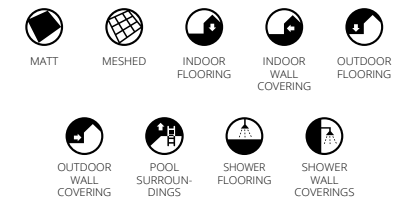

MARBLE / MÁRMOL / MARBRE

Butech: Colorstuk Rapid Manhattan

Pcs	m2	Kg
9 x Cj 486 x Pal	0,81 x Cj 43,74 x Pal	16,47 x Cj 889,38 x Pal

Paradise



Paradise Minibroken Edge Negro

32x32x1cm - 12 5/8"x12 5/8"x3/8"
100068135 - L108006681 - G-110



BASALT / BASALTO / BASALTE

Butech: Colorstuk Rapid Antracita

Pcs	m2	Kg
9 x Cj	54 x Cj	20,96 x Cj
0,92 x Pal	49,77 x Pal	1131,89 x Pal



Paradise Minibroken Edge Blanco

32x32x1cm - 12 5/8"x12 5/8"x3/8"
100068134 - L108006671 - G-110



MARBLE / MÁRMOL / MARBRE

Butech: Colorstuk Rapid Marfil

Pcs	m2	Kg
9 x Cj	54 x Cj	20,96 x Cj
0,92 x Pal	49,77 x Pal	1131,89 x Pal



Paradise Round Stone Negro

31,5x31,5x1cm - 12 3/8"x12 3/8"x3/8"
100068032 - L154201511 - G-110

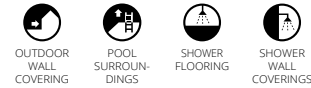

BASALT / BASALTO / BASALTE

Butech: Colorstuk Rapid Antracita

Pcs	m2	Kg
9 x Cj	54 x Cj	21,15 x Cj
0,89 x Pal	48,22 x Pal	1142,10 x Pal



Paradise Round Stone Blanco

31,5x31,5x1cm - 12 3/8"x12 3/8"x3/8"
100068031 - L154201521 - G-110



MARBLE / MÁRMOL / MARBRE

Butech: Colorstuk Rapid Marfil

Pcs	m2	Kg
9 x Cj	54 x Cj	21,15 x Cj
0,89 x Pal	48,22 x Pal	1142,10 x Pal



Paradise Tinybroken Cubes Negro

31,5x31,5x0,9cm - 12 3/8"x12 3/8"x3/8"
100169406 - L241713531 - G-116

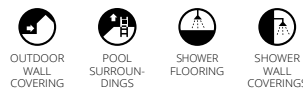

BASALT / BASALTO / BASALTE

Butech: Colorstuk Rapid Cemento

Pcs	m2	Kg
9 x Cj	0,89 x Cj	16,25 x Cj
324 x Pal	32,15 x Pal	585,14 x Pal



Paradise Tinybroken Cubes Blanco

31,5x31,5x0,9cm - 12 3/8"x12 3/8"x3/8"
100169395 - L241713511 - G-116

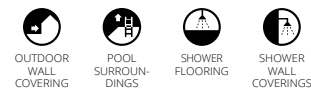

MARBLE / MÁRMOL / MARBRE

Butech: Colorstuk Rapid Marfil

Pcs	m2	Kg
9 x Cj	0,89 x Cj	16,25 x Cj
324 x Pal	32,15 x Pal	585,14 x Pal



Paradise Arrow Negro

29,2x27,2x0,8cm - 11 1/2"x10 3/4"x3/8"
100112566 - L241702581 - G-110



BASALT / BASALTO / BASALTE

Butech: Colorstuk Rapid Cemento

Pcs	m2	Kg
10 x Cj	0,79 x Cj	15,16 x Cj
360 x Pal	28,44 x Pal	545,76 x Pal



Paradise Arrow Blanco

29,2x27,2x0,8cm - 11 1/2"x10 3/4"x3/8"
100112564 - L241702541 - G-110



MARBLE / MÁRMOL / MARBRE

Butech: Colorstuk Rapid Marfil

Pcs	m2	Kg
10 x Cj	0,79 x Cj	14,69 x Cj
360 x Pal	28,44 x Pal	528,84 x Pal



Paradise Arrow Gris

29,2x27,2x0,8cm - 11 1/2"x10 3/4"x3/8"
100112565 - L241702551 - G-110



BASALT / BASALTO / BASALTE

Butech: Colorstuk Rapid Gris

Pcs	m2	Kg
10 x Cj	0,79 x Cj	15,99 x Cj
360 x Pal	28,44 x Pal	575,64 x Pal



Paradise Tinybroken Edge Negro

31x31x0,8cm - 12 1/4"x12 1/4"x3/8"
100112570 - L241702571 - G-110



BASALT / BASALTO / BASALTE

Butech: Colorstuk Rapid Cemento

Pcs	m2	Kg
9 x Cj	0,87 x Cj	6,30 x Cj
324 x Pal	31,32 x Pal	586,80 x Pal

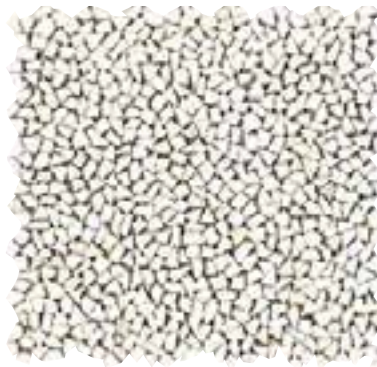

Paradise Tinybroken Edge Blanco

31x31x0,8cm - 12 1/4"x12 1/4"x3/8"
100112568 - L241702561 - G-110



MARBLE / MÁRMOL / MARBRE

Butech: Colorstuk Rapid Marfil

Pcs	m2	Kg
9 x Cj	0,87 x Cj	16,25 x Cj
324 x Pal	31,32 x Pal	585 x Pal



Paradise Tinybroken Edge Gris

31x31x0,8cm - 12 1/4"x12 1/4"x3/8"
100112569 - L241702591 - G-110



BASALT / BASALTO / BASALTE

Butech: Colorstuk Rapid Gris

Pcs	m2	Kg
9 x Cj	0,87 x Cj	16,58 x Cj
324 x Pal	31,32 x Pal	596,88 x Pal

• STOCK

Form



Form Hub White

26x26x1cm - 10 1/4"x10 1/4"x3/8"
100214533 - L241715551 - G-114



MARBLE / MÁRMOL / MARBRE

Butech: Colorstuk Rapid Blanco

Pcs	m2	Kg
10 x Cj 420 x Pal	0,67 x Cj 28,39 x Pal	14,23 x Cj 597,66 x Pal



Form Hub Cream

26x26x1cm - 10 1/4"x10 1/4"x3/8"
100214504 - L241715531 - G-114



MARBLE / MÁRMOL / MARBRE

Butech: Colorstuk Rapid Beige

Pcs	m2	Kg
10 x Cj 420 x Pal	0,67 x Cj 28,39 x Pal	14,23 x Cj 597,66 x Pal



Form Hub Brown

26x26x1cm - 10 1/4"x10 1/4"x3/8"
100214532 - L241715541 - G-114



MARBLE / MÁRMOL / MARBRE

Butech: Colorstuk Rapid Antracita

Pcs	m2	Kg
10 x Cj 420 x Pal	0,67 x Cj 28,39 x Pal	14,23 x Cj 597,66 x Pal



Form Abstract White

21x23x1cm - 8 1/4"x9"x3/8"
100213724 - L241715351 - G-112



MARBLE / MÁRMOL / MARBRE

Butech: Colorstuk Rapid Blanco

Pcs	m2	Kg
10 x Cj 420 x Pal	0,48 x Cj 20,28 x Pal	11,35 x Cj 476,70 x Pal



Form Abstract Cream

21x23x1cm - 8 1/4"x9"x3/8"
100213686 - L241715341 - G-112



MARBLE / MÁRMOL / MARBRE

Butech: Colorstuk Rapid Beige

Pcs	m2	Kg
10 x Cj 420 x Pal	0,48 x Cj 20,28 x Pal	11,35 x Cj 476,70 x Pal



Form Abstract Brown

21x23x1cm - 8 1/4"x9"x3/8"
100213732 - L241715371 - G-112

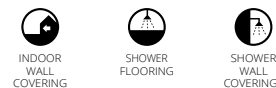

MARBLE / MÁRMOL / MARBRE

Butech: Colorstuk Rapid Beige

Pcs	m2	Kg
10 x Cj 420 x Pal	0,48 x Cj 20,28 x Pal	11,35 x Cj 476,70 x Pal





Skyline Linear Broken Dark

14,4x29,4x1,3cm - 5 5/8"x11 5/8"x1/2"
100111415 - L241702451 - G-135



SLATE / PIZARRA / ARDOISE

No supported grouting / No admite rejuntado /
Ne peut pas être jointoyé.

Pcs	m2	Kg
8 x Cj 288 x Pal	0,34 x Cj 12,19 x Pal	14,24 x Cj 512,64 x Pal

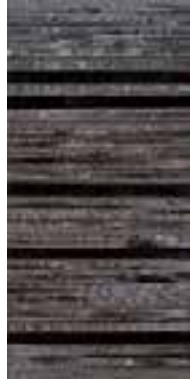

Skyline Mix Broken Dark

14,5x29,3x1,3cm - 5 3/4"x11 1/2"x1/2"
100135766 - L241709541 - G-142



SLATE / PIZARRA / ARDOISE

No supported grouting / No admite rejuntado /
Ne peut pas être jointoyé.

Pcs	m2	Kg
8 x Cj 288 x Pal	0,33 x Cj 11,73 x Pal	9,97 x Cj 358,85 x Pal



Skyline Blind Dark

30x30x2cm - 11 3/4"x11 3/4"x3/4"
100213708 - L241715321 - G-159



SLATE / PIZARRA / ARDOISE

No supported grouting / No admite rejuntado /
Ne peut pas être jointoyé.

Pcs	m2	Kg
3 x Cj 108 x Pal	0,27 x Cj 9,72 x Pal	8,23 x Cj 296,24 x Pal



Skyline Wave Dark

30x31,2x3,5cm - 11 3/4"x12 1/4"x1 3/8"
100213709 - L241715291 - G-162



SLATE / PIZARRA / ARDOISE

No supported grouting / No admite rejuntado /
Ne peut pas être jointoyé.

Pcs	m2	Kg
2 x Cj 72 x Pal	0,18 x Cj 6,74 x Pal	8,20 x Cj 295,42 x Pal



Wall Coverings Skyline Wave Dark

Luxury

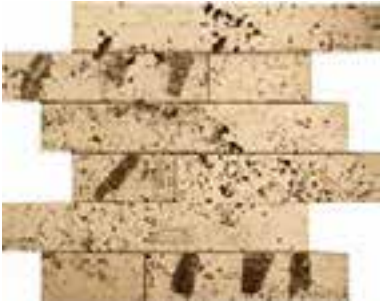

Luxury Modul Gold

30x29x1-2cm - 11 3/4"x11 3/8"x3/8"-3/4"
100113703 - L241707081 - G-156



GLOSS



MESHED



INDOOR
WALL
COVERING

ENAMELED TRAVERTINE / TRAVERTINO
ESMALTADO / TRAVERTIN ÉMAILLÉ

No supported grouting / No admite rejuntado /
Ne peut pas être jointoyé.

Pcs	m2	Kg
5 x Cj	0,44 x Cj	16,46 x Cj
210 x Pal	18,27 x Pal	691,11 x Pal

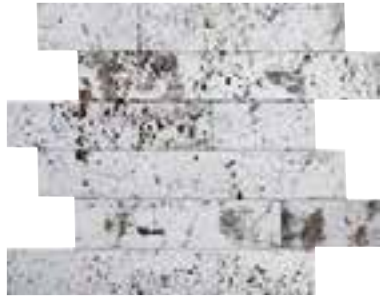

Luxury Modul Silver

30x29x1-2cm - 11 3/4"x11 3/8"x3/8"-3/4"
100113704 - L241707021 - G-156



GLOSS



MESHED



INDOOR
WALL
COVERING

ENAMELED TRAVERTINE / TRAVERTINO
ESMALTADO / TRAVERTIN ÉMAILLÉ

No supported grouting / No admite rejuntado /
Ne peut pas être jointoyé.

Pcs	m2	Kg
5 x Cj	0,44 x Cj	15,11 x Cj
210 x Pal	18,27 x Pal	634,62 x Pal



Luxury Modul Copper

30x29x1-2cm - 11 3/4"x11 3/8"x3/8"-3/4"
100113702 - L241707041 - G-156



GLOSS



MESHED



INDOOR
WALL
COVERING

ENAMELED TRAVERTINE / TRAVERTINO
ESMALTADO / TRAVERTIN ÉMAILLÉ

No supported grouting / No admite rejuntado /
Ne peut pas être jointoyé.

Pcs	m2	Kg
5 x Cj	0,44 x Cj	15,84 x Cj
210 x Pal	18,27 x Pal	665,07 x Pal



Wall Coverings Luxury Modul Gold



Magma Hexagon Black

28,4x27,7x0,8cm - 11 1/8"x10 7/8"x3/8"
100190417 - L241714571 - G-131

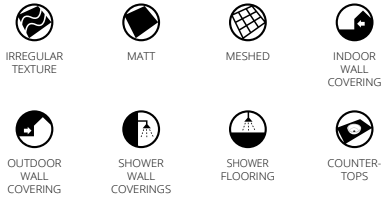

LAVA STONE / PIEDRA VOLCÁNICA / PIERRE VOLCANIQUE

Butech: Colorstuk Rapid Negro

Pcs	m2	Kg
11 x Cj	0,86 x Cj	14,45 x Cj
594 x Pal	46,73 x Pal	780,51 x Pal



Magma Hexagon Grey

28,4x27,7x0,8cm - 11 1/8"x10 7/8"x3/8"
100190425 - L241714581 - G-131

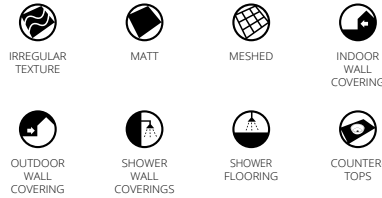

LAVA STONE / PIEDRA VOLCÁNICA / PIERRE VOLCANIQUE

Butech: Colorstuk Rapid Gris

Pcs	m2	Kg
11 x Cj	0,86 x Cj	14,45 x Cj
594 x Pal	46,73 x Pal	780,51 x Pal



Magma Hexagon Beige

28,4x27,7x0,8cm - 11 1/8"x10 7/8"x3/8"
100190433 - L241714591 - G-131

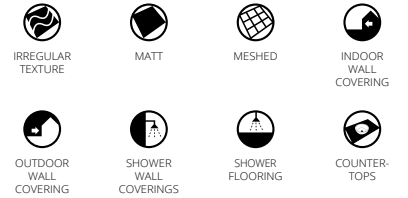

LAVA STONE / PIEDRA VOLCÁNICA / PIERRE VOLCANIQUE

Butech: Colorstuk Rapid Beige

Pcs	m2	Kg
11 x Cj	0,86 x Cj	14,45 x Cj
594 x Pal	46,73 x Pal	780,51 x Pal



Wall Coverings Magma Hexagon Beige, Signature Shell

Constellation



Constellation Chevron Brown

25,2x30,4x1cm - 9 7/8"x12"x3/8"
100203112 - L241714881 - G-140



MARBLE / MÁRMOL / MARBRE
SCREEN PRINTED / SERIGRAFÍA / ÉCRAN

Butech: Colorstuk Rapid Antracita

Pcs	m2	Kg
10 x Cj 360 x Pal	0,76 x Cj 27,58 x Pal	16,35 x Cj 588,60 x Pal



Constellation Chevron White

25,2x30,4x1cm - 9 7/8"x12"x3/8"
100201206 - L241714811 - G-140



MARBLE / MÁRMOL / MARBRE
SCREEN PRINTED / SERIGRAFÍA / ÉCRAN

Butech: Colorstuk Rapid Blanco

Pcs	m2	Kg
10 x Cj 360 x Pal	0,76 x Cj 27,58 x Pal	16,35 x Cj 588,60 x Pal



Constellation Regular Brown

30,6x31,2x1cm - 12"x12 1/4"x3/8"
100203122 - L241714871 - G-146



MARBLE / MÁRMOL / MARBRE
SCREEN PRINTED / SERIGRAFÍA / ÉCRAN

Butech: Colorstuk Rapid Antracita

Pcs	m2	Kg
10 x Cj 360 x Pal	0,95 x Cj 34,37 x Pal	16,35 x Cj 588,60 x Pal

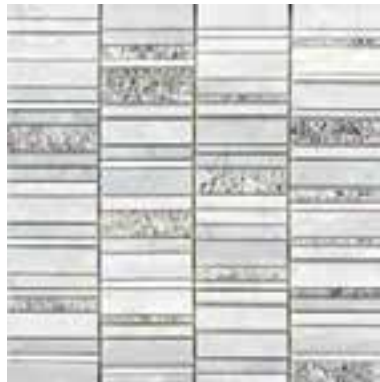

Constellation Regular White

30,6x31,2x1cm - 12"x12 1/4"x3/8"
100203103 - L241714831 - G-146



MARBLE / MÁRMOL / MARBRE
SCREEN PRINTED / SERIGRAFÍA / ÉCRAN

Butech: Colorstuk Rapid Blanco

Pcs	m2	Kg
10 x Cj 360 x Pal	0,95 x Cj 34,37 x Pal	16,35 x Cj 588,60 x Pal



Wall Coverings Constellation Chevron White



Toscana Firenze

19,6x25,8x1 cm - 7 3/4"x10 1/8"x3/8"
100213696 - L241715311 - G-146

- IRREGULAR TEXTURE
- GLOSS
- MESHED
- INDOOR FLOORING

- INDOOR WALL COVERING
- SHOWER FLOORING
- SHOWER WALL COVERINGS

MARBLE / MÁRMOL / MARBRE

Butech: Colorstuk 0-4 Blanco

Pcs	m2	Kg
10 x Cj 360 x Pal	0,50 x Cj 18,20 x Pal	10,59 x Cj 381,24 x Pal



Toscana Massa

24,8x29,8x1 cm - 9 3/4"x11 3/4"x3/8"
100213688 - L241715281 - G-146

- IRREGULAR TEXTURE
- MATT
- MESHED
- INDOOR WALL COVERING
- SHOWER WALL COVERINGS

MARBLE / MÁRMOL / MARBRE

Butech: Colorstuk 0-4 Blanco

Pcs	m2	Kg
10 x Cj 240 x Pal	0,74 x Cj 17,73 x Pal	16,83 x Cj 403,92 x Pal



Wall Coverings Toscana Firenze

Weft



Weft Beige

32x31,2x0,8cm - 12 5/8"x12 1/4"x3/8"
100213736 - L241715381 - G-140



MARBLE / MÁRMOL / MARBRE

Butech: Colorstuk 0-4 Beige

Pcs	m2	Kg
10 x Cj	0,99 x Cj	16,92 x Cj
480 x Pal	47,92 x Pal	812,16 x Pal



Weft Grey

32x31,2x0,8cm - 12 5/8"x12 1/4"x3/8"
100213725 - L241715331 - G-140



MARBLE / MÁRMOL / MARBRE

Butech: Colorstuk 0-4 Gris

Pcs	m2	Kg
10 x Cj	0,99 x Cj	16,92 x Cj
480 x Pal	47,92 x Pal	812,16 x Pal



Wall Coverings Weft Beige



Universe Aurora

30,8x26,8x1cm - 12 1/2"x10 1/2"x3/8"
100214505 - L241715411 - G-133



LAVA STONE / PIEDRA VOLCÁNICA / PIERRE VOLCANIQUE

Butech: Colorstuk 0-4 Antracita

Pcs	m2	Kg
9 x Cj	0,74 x Cj	17,70 x Cj
432 x Pal	35,65 x Pal	849,74 x Pal

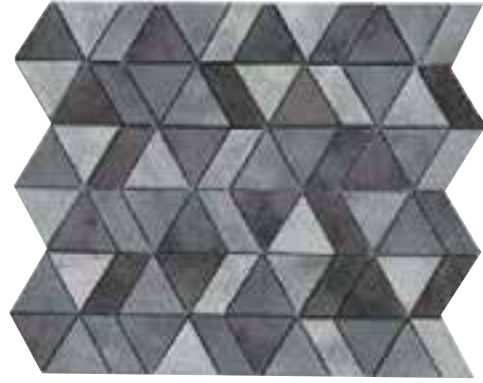

Universe Dusk

30,8x26,8x1cm - 12 1/2"x10 1/2"x3/8"
100214534 - L241715421 - G-133



LAVA STONE / PIEDRA VOLCÁNICA / PIERRE VOLCANIQUE

Butech: Colorstuk 0-4 Antracita

Pcs	m2	Kg
9 x Cj	0,74 x Cj	17,70 x Cj
432 x Pal	35,65 x Pal	849,74 x Pal



Universe Hexagon Green

26,7x23x0,8cm - 10 1/2"x9"x3/8"
100214507 - L241715391 - G-130



LAVA STONE / PIEDRA VOLCÁNICA / PIERRE VOLCANIQUE

Butech: Colorstuk 0-4 Antracita

Pcs	m2	Kg
9 x Cj	0,55 x Cj	15,37 x Cj
432 x Pal	26,53 x Pal	737,85 x Pal



Universe Hexagon Blue

26,7x23x0,8cm - 10 1/2"x9"x3/8"
100214506 - L241715401 - G-130



LAVA STONE / PIEDRA VOLCÁNICA / PIERRE VOLCANIQUE

Butech: Colorstuk 0-4 Antracita

Pcs	m2	Kg
9 x Cj	0,55 x Cj	15,37 x Cj
432 x Pal	26,53 x Pal	737,85 x Pal





Floor Coverings Amsterdam Grey Sand / Wall Coverings Universe Dusk / Complementary Products Karon Circle Countertop, Tower Mirror



Smooth and solid, clean and dry surface.

Superficie lisa y consistente, además de seca y limpia.

Surface lisse et consistante ; elle doit aussi être sèche et propre.

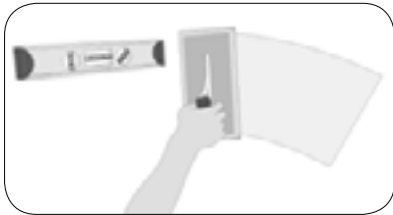

Level the surface in order to create a white background

Nivelar la superficie para crear un fondo blanco.

Niveler la surface pour créer un fond blanc.

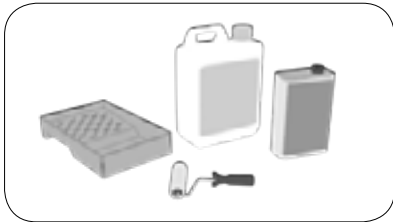

For levels greater than 2mm, we recommend the use of specific products.

En nivelados superiores a 2mm se recomienda el uso de productos específicos.

Pour des nivelages supérieurs à 2mm, l'usage de produits spécifiques est recommandé.

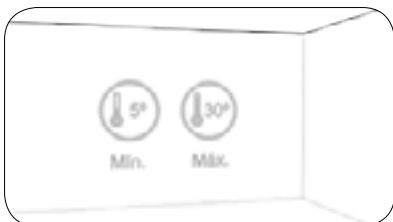

Room temperature between 5°C and 30°C

Temperatura ambiente entre 5°C y 30°C.

Température ambiante entre 5°C et 30°C.



Prepare the adhesive following the manufacturer's instructions; we recommend One-Flex.

Preparar el adhesivo siguiendo las instrucciones del fabricante, recomendamos One-Flex.

Préparer l'adhésif selon les instructions du fabricant. Nous recommandons l'utilisation de One-Flex.

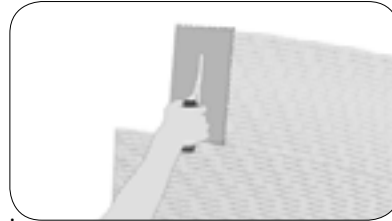

"Comb" the adhesive with the notched side (minimum notch 3mm.) Do not spread the cement-based adhesive over large areas to prevent it from drying before placing the material.

"Peinar" el adhesivo con el lado dentado (mínimo 3mm). No extender el cemento cola en grandes superficies para evitar que se reseque antes de colocar el material.

«Brosser» l'adhésif avec la face dentelée (minimum 3mm). Ne pas étaler le ciment-colle sur de grandes surfaces, afin d'éviter qu'il sèche avant la pose du matériel.



Lay the sheet and press evenly with a rubber trowel.

Colocar la hoja y presionar uniformemente con una llana de goma.

Placer la feuille et presser uniformément avec une truelle en caoutchouc.

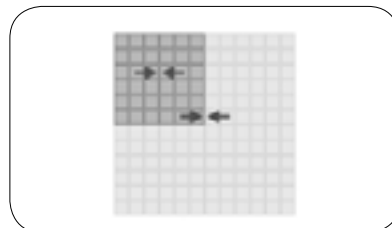

Ensure that the distance between the sheets is the same between pieces.

Asegurarse que la distancia entre hojas sea la misma entre las piezas.

Vérifiez que la distance entre les feuilles et la même que celle entre les pièces.

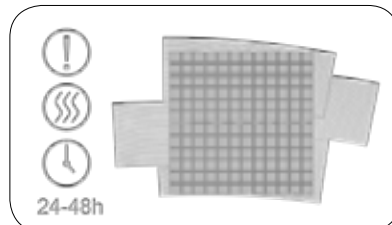

Let the adhesive dry for at least 24-48h. Before the adhesive dries, remove its remains with a sponge or cloth.

Dejar secar el adhesivo al menos 24-48h. Antes de que fragüe el adhesivo retirar los restos con una esponja o un trapo.

Laisser l'adhésif sécher pendant au moins 24 à 48h. Avant la prise de l'adhésif, retirer les restes à l'aide d'une éponge ou d'un chiffon.

GROUTING (applicable only for mosaics with joint)

REJUNTADO (aplicable sólo para mosaicos con junta)

REJOINTOIEMENT (applicable uniquement pour les mosaïques posées avec joint)

Perfectly clean pieces, and free from dust residue before grouting.

Piezas perfectamente limpias y sin restos de residuos de polvo antes de proceder al rejuntado.

Pièces parfaitement propres et sans poussière avant la phase de réalisation des joints.

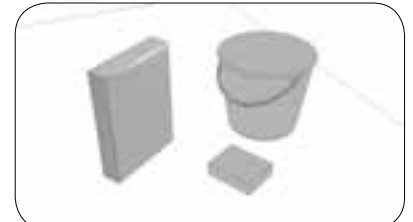

We recommend the use of Colorstuk rapid

Se recomienda el uso de Colorstuk rapid.

L'utilisation de Colorstuk rapid est recommandée.

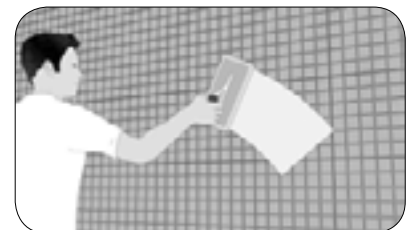

Spread the material with a rubber trowel, filling joints well.

Extender el material con una llana de goma rellenando bien las juntas.

Étaler le matériel avec une truelle en caoutchouc en remplissant bien les joints.

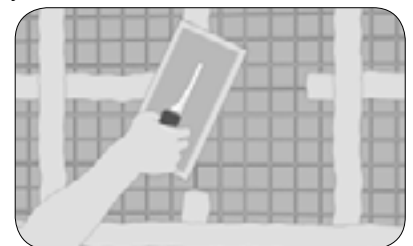

Installation / Instalación / Installation

Use the same trowel to remove excess grout.

Utilizar la misma llana para eliminar el exceso.

Utiliser la même truelle pour éliminer le produit excédant.



Before the material dries, remove its remains with a sponge or cloth.

Antes de que fragüe el material, retirar los restos con una esponja o trapo.

Avant la prise du matériel, retirer les excédents à l'aide d'une éponge ou d'un chiffon.

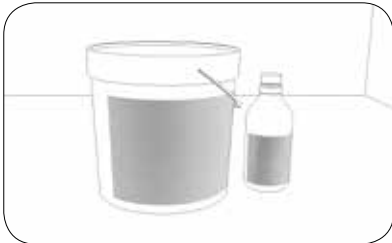

For installations where the material is in contact with water (directly or

indirectly), seal the grout adhesive by applying Fila Fob. We recommend Butech's Epotech Aqua as grouting material.

Para instalaciones en las que el material esté en contacto con agua (directa o indirectamente) sellar el adhesivo de rejunte aplicando FILAFOB. Se recomienda Epotech Aqua de Butech como material de rejunte.

Pour des installations où le matériel soit en contact avec de l'eau (directement ou indirectement), sceller l'adhésif des joints avec Fila Fob. Nous recommandons l'utilisation d'Epotech Aqua de Butech pour faire les joints.

You can see these installation instructions, as well as maintenance instructions, updated and with more detail, by visiting our website www.anticcolonial.com

Puedes revisar estas instrucciones de instalación, así como las de mantenimiento, actualizadas y con más detalle visitando nuestra página web www.anticcolonial.com

Pour réviser ces instructions d'installation, ainsi que celles d'entretien, mises à jour et plus détaillées, veuillez visiter notre site Internet www.anticcolonial.com



Victorian Collection

-



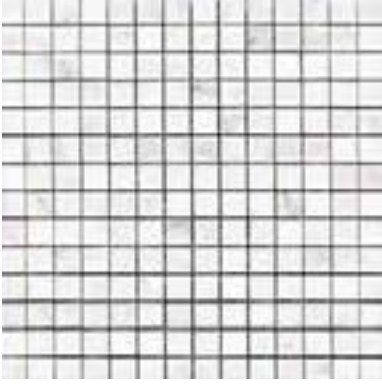

Victorian Blanco Marmara
2x2cm - 3/4"x3/4"

29x29x1cm - 11 3/8"x11 3/8"x3/8"
100000580 - L119487001 - G-113

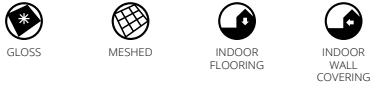

MARBLE / MÁRMOL / MARBRE

Butech: Colorstuk Rapid Blanco

Pcs	m2	Kg
10 x Cj 360 x Pal	0,84 x Cj 30,28 x Pal	19,31 x Cj 695,16 x Pal



Victorian Island Star White

24x24x0,7cm - 9 1/2"x9 1/2"x1/4"
100200258 - L244007331 - G-111



RECYCLED GLASS / VIDRIO RECICLADO / VERRE RECYCLÉ

Butech: Colorstuk Rapid Blanco

Pcs	m2	Kg
12 x Cj 720 x Pal	0,69 x Cj 41,47 x Pal	8,94 x Cj 536,40 x Pal



Victorian Trenzado Marmara Negro

30x30x1cm - 11 3/4"x11 3/4"x3/8"
100000333 - L114587001 - G-126



MARBLE / MÁRMOL / MARBRE

Butech: Colorstuk Rapid Blanco

Pcs	m2	Kg
10 x Cj 360 x Pal	0,90 x Cj 32,40 x Pal	23,18 x Cj 834,48 x Pal



Victorian Chain Marmara Mirror

25,4x24,6x1cm - 10"x9 5/8"x3/8"
100081159 - L108008751 - G-138



MARBLE / MÁRMOL / MARBRE
GLASS / VIDRIO / VERRE

Butech: Colorstuk Rapid Blanco

Pcs	m2	Kg
10 x Cj 480 x Pal	0,63 x Cj 29,99 x Pal	17,22 x Cj 826,56 x Pal



Victorian Chain Marmara-Marquina

25,4x24,6x1cm - 10"x9 5/8"x3/8"
100081164 - L115979011 - G-137



MARBLE / MÁRMOL / MARBRE

Butech: Colorstuk Rapid Blanco

Pcs	m2	Kg
10 x Cj 480 x Pal	0,63 x Cj 29,99 x Pal	17,18 x Cj 824,64 x Pal



Victorian Diamond Marmara-Mirror

32,9x28,3x1cm - 13"x11 1/8"x3/8"
100081166 - L119379011 - G-151



MARBLE / MÁRMOL / MARBRE
GLASS / VIDRIO / VERRE

Butech: Colorstuk Rapid Blanco

Pcs	m2	Kg
10 x Cj 360 x Pal	0,93 x Cj 33,48 x Pal	25,55 x Cj 919,80 x Pal

• STOCK

Victorian Collection



Victorian Trenzado Marmara Gris

30x30x1cm - 11 3/4"x11 3/4"x3/8"
100162246 - L241713351 - G-126



MARBLE / MÁRMOL / MARBRE
TRAVERTINE / TRAVERTINO / TRAVERTIN

Butech: Colorstuk Rapid Blanco

Pcs	m2	Kg
10 x Cj 360 x Pal	0,90 x Cj 32,40 x Pal	23,18 x Cj 834,48 x Pal



Victorian Mother of Pearl Brown

29x30,3x0,8cm - 11 3/8"x11 11/16"x3/8"
100153500 - L241710691 - G-143



MOTHER OF PEARL / MADRE PERLA / NACRE

Butech: Colorstuk Special Moka

Pcs	m2	Kg
9 x Cj 648 x Pal	0,79 x Cj 56,93 x Pal	9,03 x Cj 650,59 x Pal



Victorian Mother of Pearl White

29x30,3x0,8cm - 11 3/8"x11 11/16"x3/8"
100153478 - L241710671 - G-143



MOTHER OF PEARL / MADRE PERLA / NACRE

Butech: Colorstuk Special Nacare

Pcs	m2	Kg
9 x Cj 648 x Pal	0,79 x Cj 56,93 x Pal	9,03 x Cj 650,59 x Pal



Victorian Mother of Pearl Grey

29x30,3x0,8cm - 11 3/8"x11 11/16"x3/8"
100153501 - L241710681 - G-143



MOTHER OF PEARL / MADRE PERLA / NACRE

Butech: Colorstuk Special Dakar

Pcs	m2	Kg
9 x Cj 648 x Pal	0,79 x Cj 56,93 x Pal	9,03 x Cj 650,59 x Pal



Wall Coverings Victorian Mother of Pearl Grey

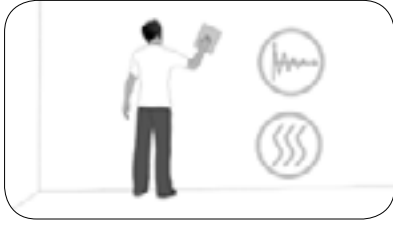

Smooth and solid, clean and dry surface.

Superficie lisa y consistente, además de seca y limpia.

Surface lisse et consistante; elle doit aussi être sèche et propre.

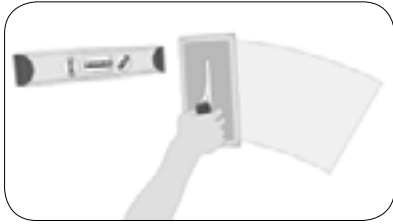

Level the surface in order to create a white background

Nivelar la superficie para crear un fondo blanco.

Niveler la surface pour créer un fond blanc.

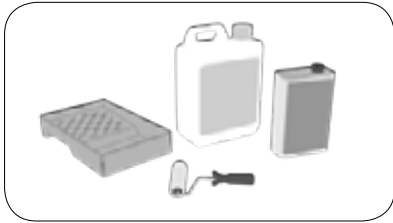

For levels greater than 2mm, we recommend the use of specific products.

En nivelados superiores a 2mm se recomienda el uso de productos específicos.

Pour des nivelados supérieurs à 2mm, l'usage de produits spécifiques est recommandé.



Room temperature between 5°C and 30°C

Temperatura ambiente entre 5°C y 30°C.

Température ambiante entre 5°C et 30°C.

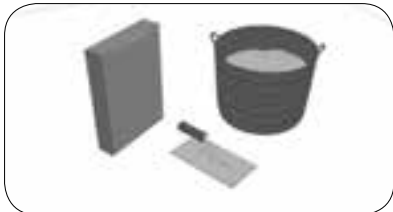

Prepare the adhesive following the manufacturer's instructions; we recommend One-Flex.

Preparar el adhesivo siguiendo las instrucciones del fabricante, recomendamos One-flex.

Préparer l'adhésif selon les instructions du fabricant. Nous recommandons l'utilisation de One-Flex.

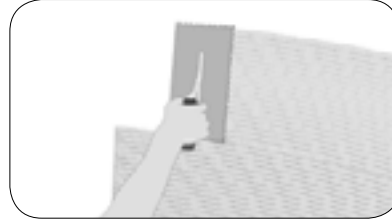

"Comb" the adhesive with the notched side (minimum notch 3mm.) Do not spread the cement-based adhesive over large areas to prevent it from drying before placing the material.

"Peinar" el adhesivo con el lado dentado (mínimo 3mm). No extender el cemento cola en grandes superficies para evitar que se reseque antes de colocar el material.

«Brosser» l'adhésif avec la face dentelée (minimum 3mm). Ne pas étaler le ciment-colle sur de grandes surfaces, afin d'éviter qu'il sèche avant la pose du matériel.



Lay the sheet and press evenly with a rubber trowel.

Colocar la hoja y presionar uniformemente con una llana de goma.

Placer la feuille et presser uniformément avec une truelle en caoutchouc.

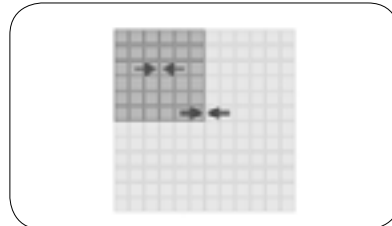

Ensure that the distance between the sheets is the same between pieces.

Asegurarse que la distancia entre hojas sea la misma entre las piezas.

Vérifiez que la distance entre les feuilles et la même que celle entre les pièces.

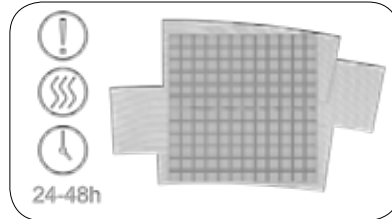

Let the adhesive dry for at least 24-48h. Before the adhesive dries, remove its remains with a sponge or cloth.

Dejar secar el adhesivo al menos 24-48h. Antes de que fragüe el adhesivo retirar los restos con una esponja o un trapo.

Laisser l'adhésif sécher pendant au moins 24 à 48h. Avant la prise de l'adhésif, retirer les restes à l'aide d'une éponge ou d'un chiffon.

GROUTING

REJUNTADO

REJOINTOIEMENT

Perfectly clean pieces, and free from dust residue before grouting.

Piezas perfectamente limpias y sin restos de residuos de polvo antes de proceder al rejuntado.

Pièces parfaitement propres et sans poussière avant la phase de réalisation des joints.

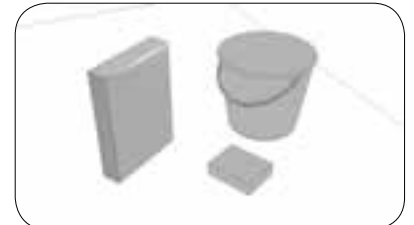

We recommend the use of Colorstuk Rapid

Se recomienda el uso de Colorstuk Rapid.

L'utilisation de Colorstuk rapid est recommandée.

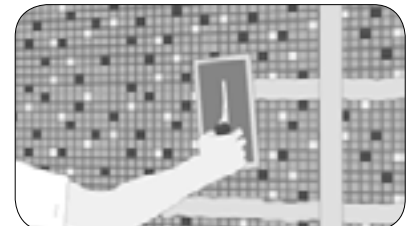

Spread the material with a rubber trowel, filling joints well.

Extender el material con una llana de goma rellenando bien las juntas.

Étaler le matériel avec une truelle en caoutchouc en remplissant bien les joints.

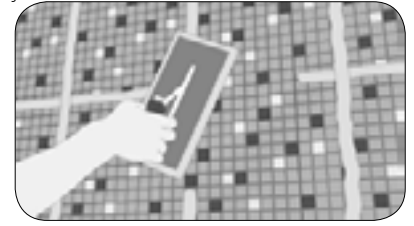

Use the same trowel to remove excess grout.

Utilizar la misma llana para eliminar el exceso.

Utiliser la même truelle pour éliminer le produit excédant.

Installation / Instalación / Installation



Before the material dries, remove its remains with a sponge or cloth.

Antes de que fragüe el material, retirar los restos con una esponja o trapo.

Avant la prise du matériel, retirer les excédents à l'aide d'une éponge ou d'un chiffon.

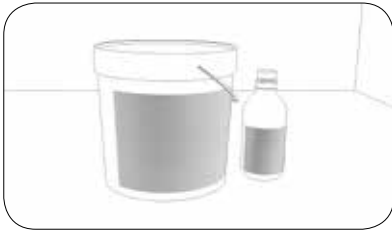

For installations where the material is in contact with water (directly or indirectly), seal the grout adhesive by applying Fila-Fob. We recommend the use of Butech's Epotech Aqua as grouting material.

Para instalaciones en las que el material esté en contacto con agua (directa o indirectamente) sellar el

adhesivo de rejunte aplicando Fila-Fob. Se recomienda el uso de Epotech Aqua de Butech como material de rejunte.

Pour des installations où le matériel est en contact avec de l'eau (directement ou indirectement), sceller l'adhésif des joints avec Fila Fob. Nous recommandons l'utilisation d'Epotech Aqua de Butech pour faire les joints.

You can see these installation instructions, as well as maintenance instructions, updated and with more detail, by visiting our website www.anticcolonial.com

Puedes revisar estas instrucciones de instalación, así como las de mantenimiento, actualizadas y con más detalle visitando nuestra página web www.anticcolonial.com

Pour réviser ces instructions d'installation, ainsi que celles d'entretien, mises à jour et plus détaillées, veuillez visiter notre site Internet www.anticcolonial.com



Wall Coverings Victorian Island Star White



Glass Mosaics

—
Glacier
Hexcube
Glaze
Aqua
Edition
Luxe Mirror
Dados
Mini Iris
Dream
Armour
Stark
Arabia
Evoke
Harmony
Effect
Urban

Wall Coverings Glaze Denim Bottle Light



Glacier Moon Metallic Black

19x29x0,8cm - 7 1/2"x11 3/8"x3/8"
100080373 - L240100021 - G-119



GLASS / VIDRIO / VERRE

Butech: Colorstuk 0-4 Negro

Pcs	m2	Kg
11 x Cj 792 x Pal	0,61 x Cj 43,64 x Pal	8,69 x Cj 625,68 x Pal

Glacier Moon Metallic White

19x29x0,8cm - 7 1/2"x11 3/8"x3/8"
100080376 - L240100011 - G-126



GLASS / VIDRIO / VERRE

Butech: Colorstuk 0-4 Blanco

Pcs	m2	Kg
11 x Cj 792 x Pal	0,61 x Cj 43,64 x Pal	8,69 x Cj 625,68 x Pal

Glacier Moon Metallic Cremas

19x29x0,8cm - 7 1/2"x11 3/8"x3/8"
100080374 - L240100031 - G-119



GLASS / VIDRIO / VERRE

Butech: Colorstuk 0-4 Marfil

Pcs	m2	Kg
11 x Cj 792 x Pal	0,61 x Cj 43,64 x Pal	8,69 x Cj 625,68 x Pal



Wall Coverings Glacier Moon Metallic Black

Hexcube



Hexcube Blue

30x29,5x0,8-1,8cm - 11 3/4"x11 5/8"x3/8-3/4"
100110387 - L242522321 - G-159



GLASS / VIDRIO / VERRE

Butech: Colorstuk Epotech Blanco

Pcs	m2	Kg
8 x Cj	0,71 x Cj	17,06 x Cj
288 x Pal	25,49 x Pal	614,02 x Pal



Hexcube Black

30x29,5x0,8-1,8cm - 11 3/4"x11 5/8"x3/8-3/4"
100110386 - L242522341 - G-159



GLASS / VIDRIO / VERRE

Butech: Colorstuk Epotech Negro

Pcs	m2	Kg
8 x Cj	0,71 x Cj	17,06 x Cj
288 x Pal	25,49 x Pal	614,02 x Pal



Wall Coverings Hexcube Blue



Glaze Mini Hexagon Black
1,5x1,5cm - 5/8"x5/8"

29,5x30x0,6cm - 11 5/8"x11 3/8"x1/4"
100173148 - L244007111 - G-113

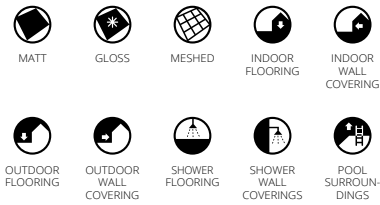

GLASS / VIDRIO / VERRE

Butech: Colorstuk 0-4 Negro

Pcs	m2	Kg
10 x Cj 600 x Pal	0,89 x Cj 53,10 x Pal	7,03 x Cj 421,80 x Pal



Glaze Mini Hexagon Grey
1,5x1,5cm - 5/8"x5/8"

29,5x30x0,6cm - 11 5/8"x11 3/8"x1/4"
100173149 - L244007081 - G-113

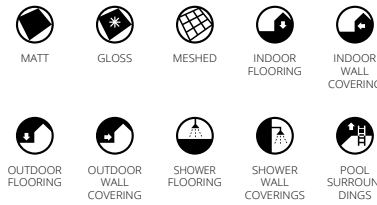

GLASS / VIDRIO / VERRE

Butech: Colorstuk 0-4 Cemento

Pcs	m2	Kg
10 x Cj 600 x Pal	0,89 x Cj 53,10 x Pal	7,03 x Cj 421,80 x Pal

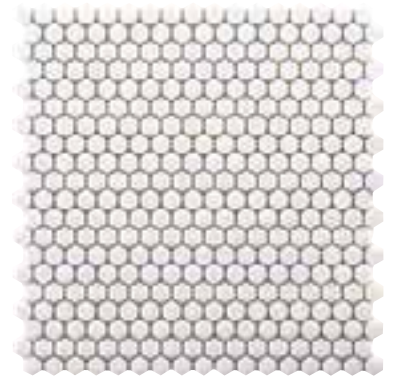

Glaze Mini Hexagon White
1,5x1,5cm - 5/8"x5/8"

29,5x30x0,6cm - 11 5/8"x11 3/8"x1/4"
100173163 - L244007131 - G-113



GLASS / VIDRIO / VERRE

Butech: Colorstuk 0-4 Blanco

Pcs	m2	Kg
10 x Cj 600 x Pal	0,89 x Cj 53,10 x Pal	7,03 x Cj 421,80 x Pal

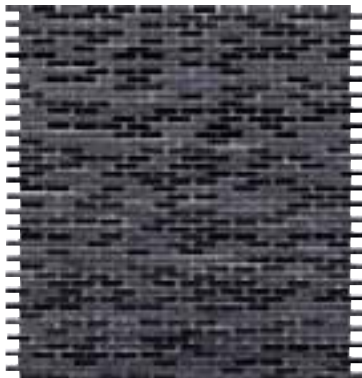

Glaze Micro Brick Black
2x0,5cm - 3/4"x 1/4"

28,4x30x0,5cm - 11 1/8"x11 3/8"x1/4"
100173154 - L244007121 - G-113

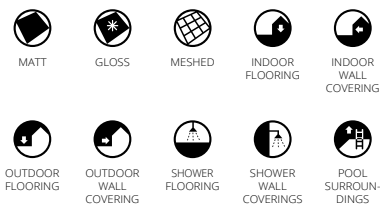

GLASS / VIDRIO / VERRE

Butech: Colorstuk 0-4 Negro

Pcs	m2	Kg
11 x Cj 660 x Pal	0,94 x Cj 56,23 x Pal	6,38 x Cj 442,86 x Pal



Glaze Micro Brick Grey
2x0,5cm - 3/4"x 1/4"

28,4x30x0,5cm - 11 1/8"x11 3/8"x1/4"
100173147 - L244007071 - G-113

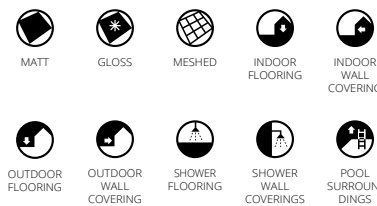

GLASS / VIDRIO / VERRE

Butech: Colorstuk 0-4 Negro

Pcs	m2	Kg
11 x Cj 660 x Pal	0,94 x Cj 56,23 x Pal	6,38 x Cj 442,86 x Pal

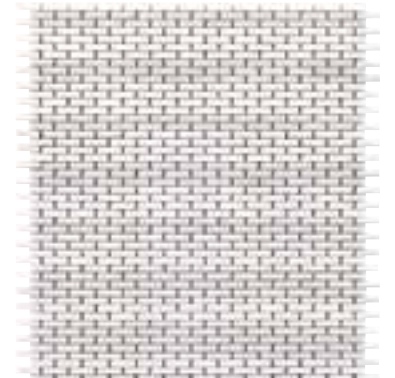

Glaze Micro Brick White
2x0,5cm - 3/4"x 1/4"

28,4x30x0,5cm - 11 1/8"x11 3/8"x1/4"
100173162 - L244007091 - G-113

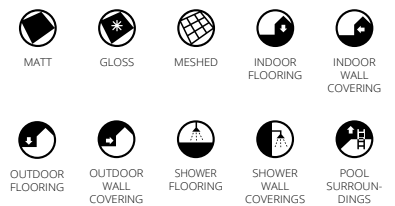

GLASS / VIDRIO / VERRE

Butech: Colorstuk 0-4 Negro

Pcs	m2	Kg
11 x Cj 660 x Pal	0,94 x Cj 56,23 x Pal	6,38 x Cj 442,86 x Pal

Glaze



Glaze Hexagon Greys / Black Matt

30,2x30x0,6cm - 11 7/8"x11 3/4"x1/4"
100169274 - L244006801 - G-113



GLASS / VIDRIO / VERRE

Butech: Colorstuk 0-4 Gris

Pcs	m2	Kg
11 x Cj	0,99 x Cj	12,52 x Cj
660 x Pal	59,79 x Pal	751,74 x Pal



Glaze Hexagon Greys Matt

30,2x30x0,6cm - 11 7/8"x11 3/4"x1/4"
100169273 - L244006791 - G-113



GLASS / VIDRIO / VERRE

Butech: Colorstuk 0-4 Gris

Pcs	m2	Kg
11 x Cj	0,99 x Cj	12,52 x Cj
660 x Pal	59,79 x Pal	751,74 x Pal



Glaze Hexagon Beiges Matt

30,2x30x0,6cm - 11 7/8"x11 3/4"x1/4"
100169291 - L244006781 - G-113



GLASS / VIDRIO / VERRE

Butech: Colorstuk 0-4 Blanco

Pcs	m2	Kg
11 x Cj	0,99 x Cj	12,52 x Cj
660 x Pal	59,79 x Pal	751,74 x Pal



Glaze Hexagon Whites Matt

30,2x30x0,6cm - 11 7/8"x11 3/4"x1/4"
100169236 - L244006811 - G-113



GLASS / VIDRIO / VERRE

Butech: Colorstuk 0-4 Blanco

Pcs	m2	Kg
11 x Cj	0,99 x Cj	12,52 x Cj
660 x Pal	59,79 x Pal	751,74 x Pal



Glaze Dots Greys / Black Matt

31,5x29x0,6cm - 12 3/8"x11 3/8"x1/4"
100169280 - L244006761 - G-113



GLASS / VIDRIO / VERRE

Butech: Colorstuk 0-4 Gris

Pcs	m2	Kg
11 x Cj	1,01 x Cj	10,74 x Cj
660 x Pal	60,29 x Pal	644,16 x Pal

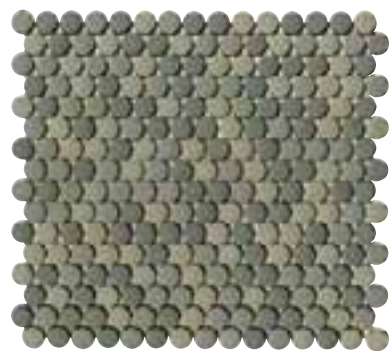

Glaze Dots Greys Matt

31,5x29x0,6cm - 12 3/8"x11 3/8"x1/4"
100169235 - L244006751 - G-113



GLASS / VIDRIO / VERRE

Butech: Colorstuk 0-4 Gris

Pcs	m2	Kg
11 x Cj	1,01 x Cj	10,74 x Cj
660 x Pal	60,29 x Pal	644,16 x Pal



Glaze Dots Beiges Matt

31,5x29x0,6cm - 12 3/8"x11 3/8"x1/4"
100169259 - L244006741 - G-113



GLASS / VIDRIO / VERRE

Butech: Colorstuk 0-4 Blanco

Pcs	m2	Kg
11 x Cj 660 x Pal	1,01 x Cj 60,29 x Pal	10,74 x Cj 644,16 x Pal

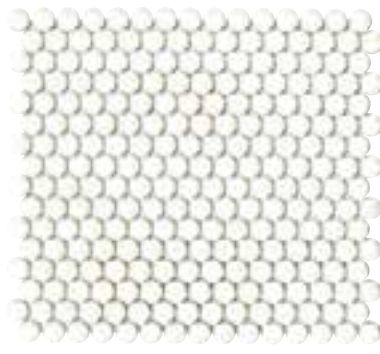

Glaze Dots Whites Matt

31,5x29x0,6cm - 12 3/8"x11 3/8"x1/4"
100169290 - L244006771 - G-113



GLASS / VIDRIO / VERRE

Butech: Colorstuk 0-4 Blanco

Pcs	m2	Kg
11 x Cj 660 x Pal	1,01 x Cj 60,29 x Pal	10,74 x Cj 644,16 x Pal

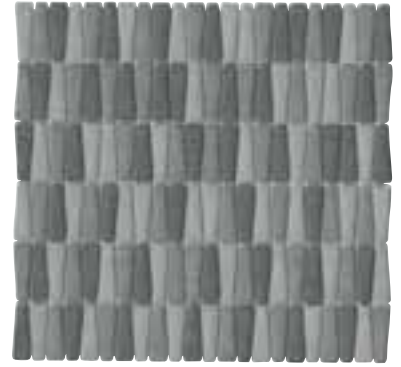

Glaze Denim Bottle Dark

30,5x29,6x0,5cm - 12"x11 5/8"x1/4"
100213733 - L244008041 - G-118



GLASS / VIDRIO / VERRE

Butech: Colorstuk 0-4 Gris

Pcs	m2	Kg
11 x Cj 660 x Pal	0,99 x Cj 59,58 x Pal	13,09 x Cj 785,40 x Pal

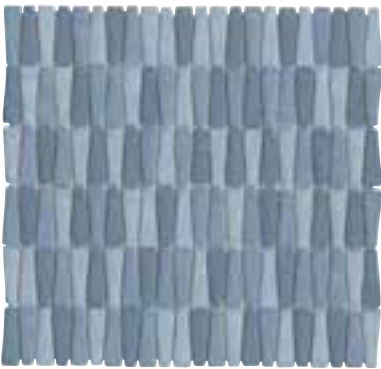

Glaze Denim Bottle Light

30,5x29,6x0,5cm - 12"x11 5/8"x1/4"
100213716 - L244008031 - G-118



GLASS / VIDRIO / VERRE

Butech: Colorstuk 0-4 Gris

Pcs	m2	Kg
11 x Cj 660 x Pal	0,99 x Cj 59,58 x Pal	13,09 x Cj 785,40 x Pal

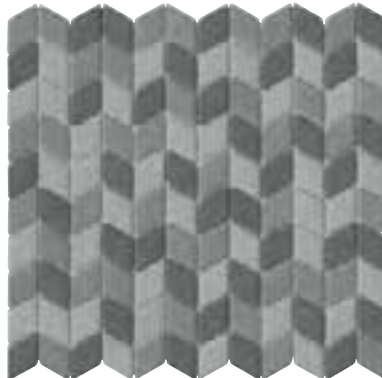

Glaze Denim Rhombus Dark

30,6x30,5x0,3-0,5cm - 12"x12"x1/8"-1/4"
100213717 - L244008051 - G-118



GLASS / VIDRIO / VERRE

Butech: Colorstuk 0-4 Gris

Pcs	m2	Kg
11 x Cj 660 x Pal	0,99 x Cj 59,58 x Pal	13,09 x Cj 785,40 x Pal



Glaze Denim Rhombus Light

30,6x30,5x0,3-0,5cm - 12"x12"x1/8"-1/4"
100213695 - L244008021 - G-118

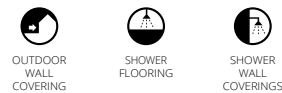

GLASS / VIDRIO / VERRE

Butech: Colorstuk 0-4 Gris

Pcs	m2	Kg
11 x Cj 660 x Pal	0,99 x Cj 59,58 x Pal	13,09 x Cj 785,40 x Pal



Aqua



Aqua Blue

32,1x30x0,6cm - 12 5/8"x11 3/4"x1/4"
100213723 - L224002771 - G-131



GLOSS



MESHED



INDOOR
WALL
COVERING



SHOWER
WALL
COVERINGS

GLASS / VIDRIO / VERRE

Butech: Colorstuk 0-4 Cemento

Pcs	m2	Kg
15 x Cj	1,44 x Cj	16,30 x Cj
630 x Pal	60,67 x Pal	684,81 x Pal



Aqua Grey

32,1x30x0,6cm - 12 5/8"x11 3/4"x1/4"
100213715 - L224002761 - G-131



GLOSS



MESHED



INDOOR
WALL
COVERING



SHOWER
WALL
COVERINGS

GLASS / VIDRIO / VERRE

Butech: Colorstuk 0-4 Cemento

Pcs	m2	Kg
15 x Cj	1,44 x Cj	16,30 x Cj
630 x Pal	60,67 x Pal	684,81 x Pal



Aqua Green

32,1x30x0,6cm - 12 5/8"x11 3/4"x1/4"
100213694 - L224002781 - G-131



GLOSS



MESHED



INDOOR
WALL
COVERING



SHOWER
WALL
COVERINGS

GLASS / VIDRIO / VERRE

Butech: Colorstuk 0-4 Cemento

Pcs	m2	Kg
15 x Cj	1,44 x Cj	16,30 x Cj
630 x Pal	60,67 x Pal	684,81 x Pal



Wall Coverings Aqua Green

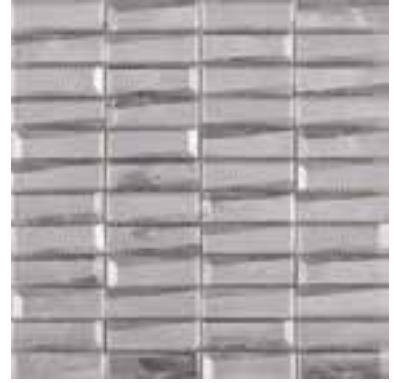

Edition Rectangular Grey
7,2x2,2cm - 2 7/8"x7/8"

29,8x29,8x0,7cm - 11 3/4"x11 3/4"x1/4"
100161755 - L241712901 - G-153



GLASS / VIDRIO / VERRE

Butech: Colorstuk Special Dark

Pcs	m2	Kg
11 x Cj	0,97 x Cj	12,10 x Cj
594 x Pal	52,74 x Pal	653,40 x Pal

Edition Rectangular Gold
7,2x2,2cm - 2 7/8"x7/8"

29,8x29,8x0,7cm - 11 3/4"x11 3/4"x1/4"
100161728 - L241712941 - G-153



GLASS / VIDRIO / VERRE

Butech: Colorstuk Special Vanilla

Pcs	m2	Kg
11 x Cj	0,97 x Cj	12,10 x Cj
594 x Pal	52,74 x Pal	653,40 x Pal

Edition Rectangular White
7,2x2,2cm - 2 7/8"x7/8"

29,8x29,8x0,7cm - 11 3/4"x11 3/4"x1/4"
100161762 - L241712911 - G-153



GLASS / VIDRIO / VERRE

Butech: Colorstuk Special Nacaré

Pcs	m2	Kg
11 x Cj	0,97 x Cj	12,10 x Cj
594 x Pal	52,74 x Pal	653,40 x Pal



Wall Coverings Edition Rectangular Grey

Luxe Mirror

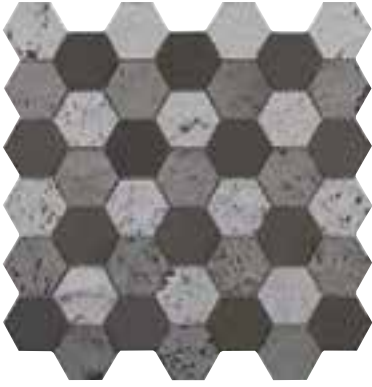

Luxe Mirror Hexagon

31,6x32,5x0,3cm - 12 1/2"x12 3/4"x1/8"
100161540 - L244006391 - G-137



GLASS / VIDRIO / VERRE

Butech: Colorstuk Special Nacaré

Pcs	m2	Kg
10 x Cj	1,02 x Cj	4,14 x Cj
600 x Pal	61,62 x Pal	248,40 x Pal



Luxe Mirror Cubes

32,5x32,5x0,3cm - 12 3/4"x12 3/4"x1/8"
100161536 - L244006381 - G-137



GLASS / VIDRIO / VERRE

Butech: Colorstuk Special Nacaré

Pcs	m2	Kg
10 x Cj	1,05 x Cj	4,14 x Cj
600 x Pal	63,37 x Pal	248,40 x Pal



Luxe Mirror Strip

27,8x32,9x0,3cm - 11"x13"x1/8"
100161528 - L244006401 - G-137



GLASS / VIDRIO / VERRE

Butech: Colorstuk Special Nacaré

Pcs	m2	Kg
10 x Cj	0,91 x Cj	4,14 x Cj
600 x Pal	54,87 x Pal	248,40 x Pal

Mosaics

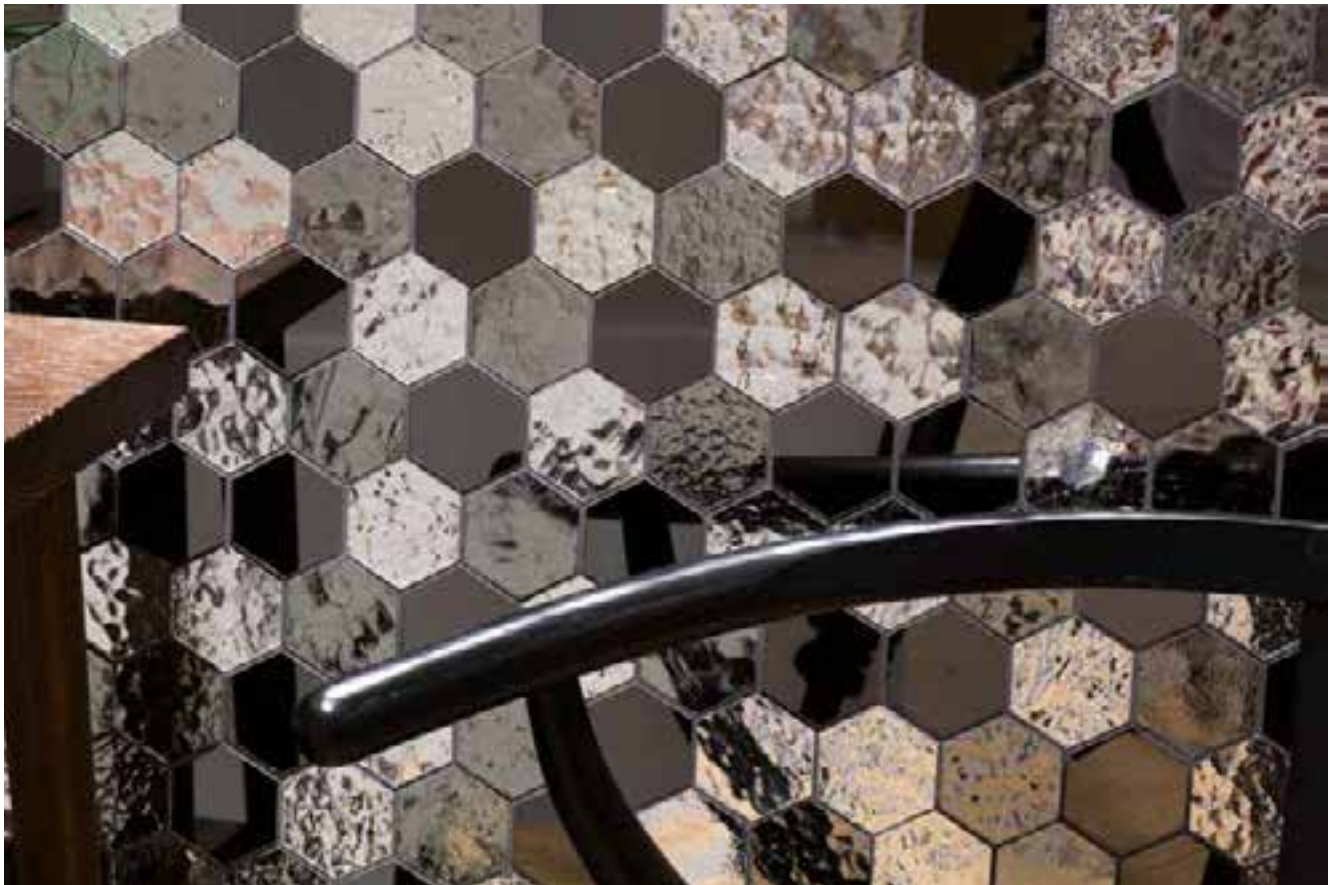

Wall Coverings Luxe Mirror Hexagon



Dados Blue

2,4X2,4cm - 1"x1"

15x30x1,4cm - 5 7/8"x11 3/4"x1/2"
100112124 - L244001191 - G-110



GLOSS



MESHED



INDOOR WALL COVERING

GLASS / VIDRIO / VERRE

No supported grouting / No admite rejuntado /
Ne peut pas être jointoyé

Pcs	m2	Kg
10 x Cj 720 x Pal	0,45 x Cj 32,40 x Pal	10,35 x Cj 745,20 x Pal



Dados Earth

2,4X2,4cm - 1"x1"

15x30x1,4cm - 5 7/8"x11 3/4"x1/2"
100112125 - L244001081 - G-110



GLOSS



MESHED



INDOOR WALL COVERING

GLASS / VIDRIO / VERRE

No supported grouting / No admite rejuntado /
Ne peut pas être jointoyé

Pcs	m2	Kg
10 x Cj 720 x Pal	0,45 x Cj 32,40 x Pal	10,35 x Cj 745,20 x Pal

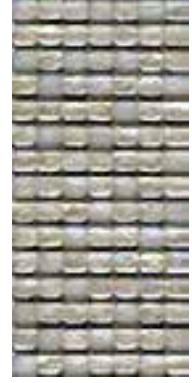

Dados Pearl Cream

2X2cm - 3/4"x3/4"

13,8x29,7x1,4 - 5 3/8"x11 3/4"x1/2"
100146031 - L244004851 - G-110



IRREGULAR TEXTURE



GLOSS



MATT



MESHED



INDOOR WALL COVERING

GLASS / VIDRIO / VERRE

No supported grouting / No admite rejuntado /
Ne peut pas être jointoyé

Pcs	m2	Kg
14 x Cj 756 x Pal	0,63 x Cj 34,02 x Pal	12,74 x Cj 687,96 x Pal



Dados Metal

2,4X2,4cm - 1"x1"

15,2x30,5x1,8cm - 6"x12"x3/4"
100103990 - L244000981 - G-110



GLOSS



MESHED



INDOOR WALL COVERING

GLASS / VIDRIO / VERRE

No supported grouting / No admite rejuntado /
Ne peut pas être jointoyé

Pcs	m2	Kg
10 x Cj 480 x Pal	0,45 x Cj 21,60 x Pal	17,80 x Cj 854,40 x Pal



Wall Coverings Dados Metal

Mini Iris



Mini Iris White Pearl 1x1cm - 3/8"x3/8"

31,5x31,5x0,4cm - 12 3/8"x12 3/8"x1/8"
100121438 - L244004051 - G-118



GLASS / VIDRIO / VERRE

Butech: Colorstuk 0-4 Blanco

Pcs	m2	Kg
16 x Cj 960 x Pal	1,62 x Cj 97,08 x Pal	9,94 x Cj 596,16 x Pal



Mini Iris Cream Pearl 1x1cm - 3/8"x3/8"

31,5x31,5x0,4cm - 12 3/8"x12 3/8"x1/8"
100121436 - L244004021 - G-118



GLASS / VIDRIO / VERRE

Butech: Colorstuk 0-4 Marfil

Pcs	m2	Kg
16 x Cj 960 x Pal	1,62 x Cj 97,08 x Pal	9,94 x Cj 596,16 x Pal



Mini Iris Grey Pearl 1x1cm - 3/8"x3/8"

31,5x31,5x0,4cm - 12 3/8"x12 3/8"x1/8"
100121437 - L244004041 - G-118



GLASS / VIDRIO / VERRE

Butech: Colorstuk 0-4 Gris

Pcs	m2	Kg
16 x Cj 960 x Pal	1,62 x Cj 97,08 x Pal	9,94 x Cj 596,16 x Pal

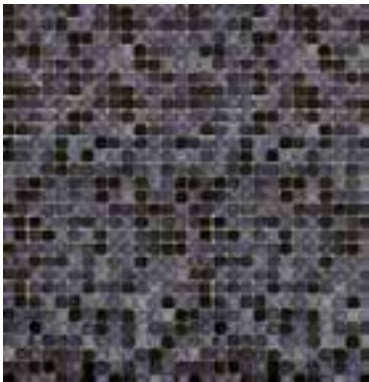

Mini Iris Black Pearl 1x1cm - 3/8"x3/8"

31,5x31,5x0,4cm - 12 3/8"x12 3/8"x1/8"
100121435 - L244004031 - G-118

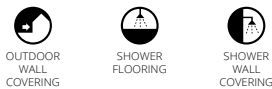

GLASS / VIDRIO / VERRE

Butech: Colorstuk 0-4 Negro

Pcs	m2	Kg
16 x Cj 960 x Pal	1,62 x Cj 97,08 x Pal	9,94 x Cj 596,16 x Pal

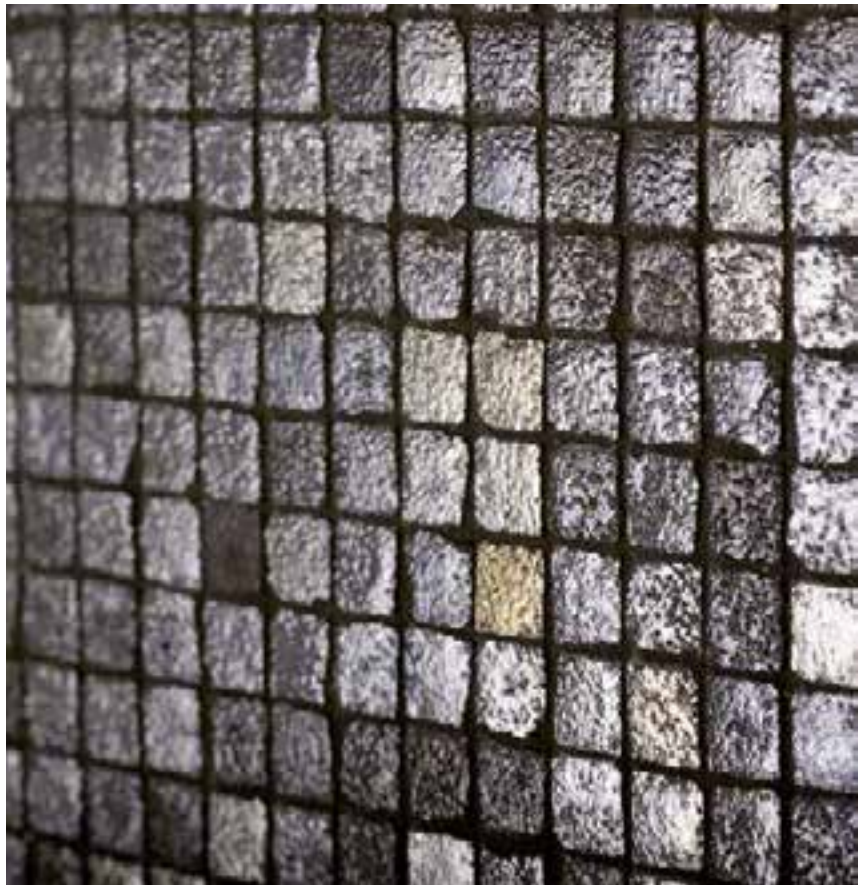

Wall Coverings Mini Iris Black Pearl

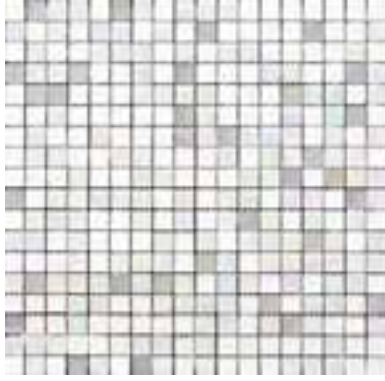

Dream Mix Whites

1,4x1,4cm - 1/2"x1/2"

29,5x29,5x0,4cm - 11 5/8"x11 5/8"x1/8"

100086102 - L244000241 - G-111

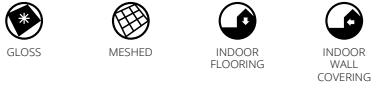

RECYCLED GLASS / VIDRIO RECICLADO / VERRE RECYCLÉ

Butech: Colorstuk 0-4 Blanco

Pcs	m2	Kg
20 x Cj	1,74 x Cj	13,04 x Cj
1200 x Pal	104,43 x Pal	782,40 x Pal

Dream White

1,4x1,4cm - 1/2"x1/2"

29,5x29,5x0,4cm - 11 5/8"x11 5/8"x1/8"

100153005 - L244005331 - G-111



RECYCLED GLASS / VIDRIO RECICLADO / VERRE RECYCLÉ

Butech: Colorstuk 0-4 Blanco

Pcs	m2	Kg
20 x Cj	1,74 x Cj	15,52 x Cj
1200 x Pal	104,46 x Pal	931,20 x Pal



Wall Coverings Dream Mix Whites

Armour



Armour Caramel

2,7X2,7cm - 1 1/8"x1 1/8"

30x30x0,8cm - 11 3/4"x11 3/4"x3/8"

100112118 - L244001111 - G-114



IRREGULAR
TEXTURE

GLOSS

MATT

MESHED



INDOOR
WALL
COVERING

OUTDOOR
WALL
COVERING

SHOWER
WALL
COVERING

GLASS / VIDRIO / VERRE

Butech: Colorstuk Special Vanilla

Pcs	m2	Kg
11 x Cj 594 x Pal	0,99 x Cj 53,46 x Pal	17,38 x Cj 938,52 x Pal



Armour Black

2,7X2,7cm - 1 1/8"x1 1/8"

30x30x0,8cm - 11 3/4"x11 3/4"x3/8"

100112117 - L244001061 - G-114



IRREGULAR
TEXTURE

GLOSS

MATT

MESHED



INDOOR
WALL
COVERING

OUTDOOR
WALL
COVERING

SHOWER
WALL
COVERING

GLASS / VIDRIO / VERRE

Butech: Colorstuk Special Dark

Pcs	m2	Kg
11 x Cj 594 x Pal	0,99 x Cj 53,46 x Pal	17,38 x Cj 938,52 x Pal



Wall Coverings Armour Caramel

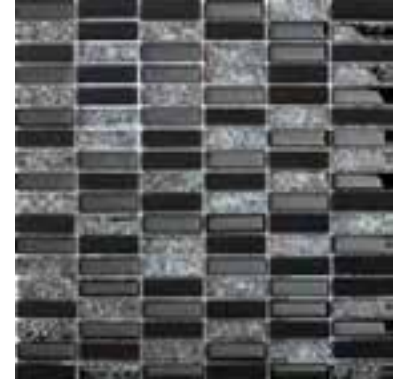

Stark White

1,4X4,7cm - 1/2"x1 7/8"

29,7x30x0,8cm - 11 3/4"x11 3/4"x3/8"
100112133 - L244001071 - G-113



GLASS / VIDRIO / VERRE

Butech: Colorstuk Special White

Pcs	m2	Kg
11 x Cj	0,98 x Cj	16,85 x Cj
594 x Pal	52,93 x Pal	910,01 x Pal

Stark Grey

1,4X4,7cm - 1/2"x1 7/8"

29,7x30x0,8cm - 11 3/4"x11 3/4"x3/8"
100112132 - L244001051 - G-113



GLASS / VIDRIO / VERRE

Butech: Colorstuk Special Nacaré

Pcs	m2	Kg
11 x Cj	0,98 x Cj	16,85 x Cj
594 x Pal	52,93 x Pal	910,01 x Pal

Stark Black

1,4X4,7cm - 1/2"x1 7/8"

29,7x30x0,8cm - 11 3/4"x11 3/4"x3/8"
100112131 - L244001041 - G-113



GLASS / VIDRIO / VERRE

Butech: Colorstuk Special Dark

Pcs	m2	Kg
11 x Cj	0,98 x Cj	16,85 x Cj
594 x Pal	52,93 x Pal	910,01 x Pal



Wall Coverings Stark White

Arabia



Arabia Silver

1,5x1,5cm - 5/8"x5/8"

29,5x29,5x0,4cm - 11 5/8"x11 5/8"x1/8"

100092712 - L244000511 - G-126



GLOSS



MESHED



OUTDOOR
WALL
COVERING



INDOOR
WALL
COVERING



SHOWER
WALL
COVERING

RECYCLED GLASS / VIDRIO RECICLADO / VERRE RECYCLÉ

Butech: Colorstuk 0-4 Blanco

Pcs	m2	Kg
20 x Cj	1,74 x Cj	13,76 x Cj
1200 x Pal	104,40 x Pal	825,60 x Pal

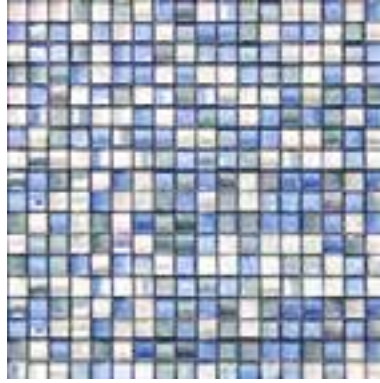

Arabia Mix Blue Silver

1,5x1,5cm - 5/8"x5/8"

29,5x29,5x0,4cm - 11 5/8"x11 5/8"x1/8"

100092710 - L244000521 - G-133



GLOSS



MESHED



OUTDOOR
WALL
COVERING



INDOOR
WALL
COVERING



SHOWER
WALL
COVERING

RECYCLED GLASS / VIDRIO RECICLADO / VERRE RECYCLÉ

Butech: Colorstuk 0-4 Blanco

Pcs	m2	Kg
20 x Cj	1,74 x Cj	13,76 x Cj
1200 x Pal	104,40 x Pal	825,60 x Pal



Arabia Sun

1,5x1,5cm - 5/8"x5/8"

29,5x29,5x0,4cm - 11 5/8"x11 5/8"x1/8"

100146007 - L241710181 - G-126



GLOSS



MESHED



OUTDOOR
WALL
COVERING



INDOOR
WALL
COVERING



SHOWER
WALL
COVERING

RECYCLED GLASS / VIDRIO RECICLADO / VERRE RECYCLÉ

Butech: Colorstuk 0-4 Beige

Pcs	m2	Kg
20 x Cj	1,74 x Cj	13,76 x Cj
1200 x Pal	104,40 x Pal	825,60 x Pal



Arabia Gold

1,5x1,5cm - 5/8"x5/8"

29,5x29,5x0,4cm - 11 5/8"x11 5/8"x1/8"

100092709 - L244000531 - G-126



GLOSS



MESHED



OUTDOOR
WALL
COVERING



INDOOR
WALL
COVERING



SHOWER
WALL
COVERING

RECYCLED GLASS / VIDRIO RECICLADO / VERRE RECYCLÉ

Butech: Colorstuk 0-4 Beige

Pcs	m2	Kg
20 x Cj	1,74 x Cj	13,76 x Cj
1200 x Pal	104,40 x Pal	825,60 x Pal



Wall Coverings Arabia Gold



Evoke Black

29,5x29,5x0,8cm - 11 5/8"x11 5/8"x3/8"
100153512 - L241710871 - G-131



GLASS / VIDRIO / VERRE

Butech: colorstuk Special Dark

Pcs	m2	Kg
10 x Cj 360 x Pal	0,87 x Cj 31,32 x Pal	14,30 x Cj 514,80 x Pal



Evoke Caramel

29,5x29,5x0,8cm - 11 5/8"x11 5/8"x3/8"
100153514 - L241710881 - G-131



GLASS / VIDRIO / VERRE

Butech: colorstuk Special Vanilla

Pcs	m2	Kg
10 x Cj 360 x Pal	0,87 x Cj 31,32 x Pal	14,30 x Cj 514,80 x Pal



Evoke Silver

29,5x29,5x0,8cm - 11 5/8"x11 5/8"x3/8"
100153519 - L241710931 - G-131



GLASS / VIDRIO / VERRE

Butech: colorstuk Special Nacaré

Pcs	m2	Kg
10 x Cj 360 x Pal	0,87 x Cj 31,32 x Pal	14,30 x Cj 514,80 x Pal



Evoke Form Black

25,7x14,8x0,95cm - 10 1/8"x5 13/16"x3/8"
100153515 - L241710911 - G-111



GLASS / VIDRIO / VERRE

Butech: colorstuk Special Dark

Pcs	m2	Kg
20 x Cj 720 x Pal	0,76 x Cj 27,38 x Pal	15,80 x Cj 568,80 x Pal



Evoke Form Caramel

25,7x14,8x0,95cm - 10 1/8"x5 13/16"x3/8"
100153517 - L241710921 - G-111



GLASS / VIDRIO / VERRE

Butech: colorstuk Special Vanilla

Pcs	m2	Kg
20 x Cj 720 x Pal	0,76 x Cj 27,38 x Pal	15,80 x Cj 568,80 x Pal



Evoke Form Silver

25,7x14,8x0,95cm - 10 1/8"x5 13/16"x3/8"
100153518 - L241710901 - G-111



GLASS / VIDRIO / VERRE

Butech: colorstuk Special Nacaré

Pcs	m2	Kg
20 x Cj 720 x Pal	0,76 x Cj 27,38 x Pal	15,80 x Cj 568,80 x Pal

Harmony



Harmony Arrow Coltan

25,8x28,4x0,8cm - 10 3/16"x11 3/16"x3/8"
100153521 - L241710711 - G-125



GLASS / VIDRIO / VERRE

Butech: Colorstuk Special Dark

Pcs	m2	Kg
11 x Cj	0,80 x Cj	13,20 x Cj
528 x Pal	38,68 x Pal	633,60 x Pal



Harmony Arrow Gold

25,8x28,4x0,8cm - 10 3/16"x11 3/16"x3/8"
100153522 - L241710721 - G-125



GLASS / VIDRIO / VERRE

Butech: Colorstuk Special Vanilla

Pcs	m2	Kg
11 x Cj	0,80 x Cj	13,20 x Cj
528 x Pal	38,68 x Pal	633,60 x Pal



Harmony Arrow Silver

25,8x28,4x0,8cm - 10 3/16"x11 3/16"x3/8"
100153523 - L241710701 - G-125



GLASS / VIDRIO / VERRE

Butech: Colorstuk Special Nacaré

Pcs	m2	Kg
11 x Cj	0,80 x Cj	13,20 x Cj
528 x Pal	38,68 x Pal	633,60 x Pal



Harmony Strip Coltan

29,4x30x0,8cm - 11 9/16"x11 3/4"x3/8"
100153524 - L241710771 - G-134



GLASS / VIDRIO / VERRE

Butech: Colorstuk Special Dark

Pcs	m2	Kg
11 x Cj	0,97 x Cj	16,50 x Cj
528 x Pal	46,56 x Pal	792 x Pal



Harmony Strip Gold

29,4x30x0,8cm - 11 9/16"x11 3/4"x3/8"
100153525 - L241710741 - G-134



GLASS / VIDRIO / VERRE

Butech: Colorstuk Special Vanilla

Pcs	m2	Kg
11 x Cj	0,97 x Cj	16,50 x Cj
528 x Pal	46,56 x Pal	792 x Pal



Harmony Strip Silver

29,4x30x0,8cm - 11 9/16"x11 3/4"x3/8"
100153526 - L241710731 - G-134



GLASS / VIDRIO / VERRE

Butech: Colorstuk Special Nacaré

Pcs	m2	Kg
11 x Cj	0,97 x Cj	16,50 x Cj
528 x Pal	46,56 x Pal	792 x Pal

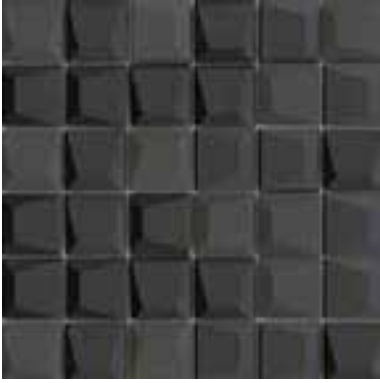

Effect Square Black

30x30x0,8cm - 11 3/4"x11 3/4"x3/8"
100203104 - L244007371 - G-133



GLASS / VIDRIO / VERRE

Butech: Colorstuk Special Dark

Pcs	m2	Kg
11 x Cj	0,99 x Cj	16,39 x Cj
528 x Pal	47,52 x Pal	786,72 x Pal

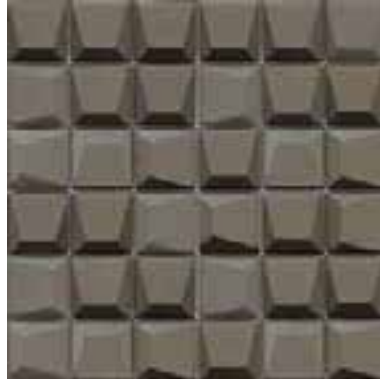

Effect Square Caramel

30x30x0,8cm - 11 3/4"x11 3/4"x3/8"
100203113 - L244007391 - G-133



GLASS / VIDRIO / VERRE

Butech: Colorstuk Special Moka

Pcs	m2	Kg
11 x Cj	0,99 x Cj	16,39 x Cj
528 x Pal	47,52 x Pal	786,72 x Pal



Effect Square Silver

30x30x0,8cm - 11 3/4"x11 3/4"x3/8"
100203123 - L244007361 - G-133



GLASS / VIDRIO / VERRE

Butech: Colorstuk Special Nacaré

Pcs	m2	Kg
11 x Cj	0,99 x Cj	16,39 x Cj
528 x Pal	47,52 x Pal	786,72 x Pal



Effect Square White

30x30x0,8cm - 11 3/4"x11 3/4"x3/8"
100203094 - L244007381 - G-133



GLASS / VIDRIO / VERRE

Butech: Colorstuk Special White

Pcs	m2	Kg
11 x Cj	0,99 x Cj	16,39 x Cj
528 x Pal	47,52 x Pal	786,72 x Pal



Floor Coverings Moka Classico / Wall Coverings Effect Square Caramel

Urban



Urban Retro Iron

6x24x0,8cm - 2 3/8"x9 7/16"x3/8"
100156148 - L244005701 - G-104



GLASS / VIDRIO / VERRE

Butech: Colorstuk Special White

Pcs	m2	Kg
30 x Cj	0,43 x Cj	8,16 x Cj
1620 x Pal	23,32 x Pal	440,64 x Pal



Urban Retro Lead

6x24x0,8cm - 2 3/8"x9 7/16"x3/8"
100156149 - L244005711 - G-104



GLASS / VIDRIO / VERRE

Butech: Colorstuk Special Vanilla

Pcs	m2	Kg
30 x Cj	0,43 x Cj	8,16 x Cj
1620 x Pal	23,32 x Pal	440,64 x Pal



Urban Retro Silver

6x24x0,8cm - 2 3/8"x9 7/16"x3/8"
100156171 - L244005671 - G-104



GLASS / VIDRIO / VERRE

Butech: Colorstuk Special Nacare

Pcs	m2	Kg
30 x Cj	0,43 x Cj	8,16 x Cj
1620 x Pal	23,32 x Pal	440,64 x Pal



Urban Retro Nickel

6x24x0,8cm - 2 3/8"x9 7/16"x3/8"
100156170 - L244005681 - G-104



GLASS / VIDRIO / VERRE

Butech: Colorstuk Special Moka

Pcs	m2	Kg
30 x Cj	0,43 x Cj	8,16 x Cj
1620 x Pal	23,32 x Pal	440,64 x Pal



Wall Coverings Urban Retro Nickel

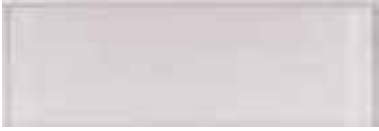

Urban Line Iron

30x10x0,8cm - 3 15/16"x11 3/4"x3/8"
100153506 - L244005431 - G-108



GLASS / VIDRIO / VERRE

Butech: Colorstuk Special White

Pcs	m2	Kg
30 x Cj	0,90 x Cj	17,67 x Cj
1080 x Pal	32,40 x Pal	636,34 x Pal

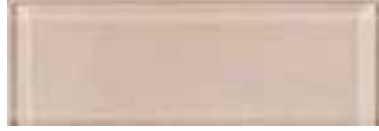

Urban Line Lead

30x10x0,8cm - 3 15/16"x11 3/4"x3/8"
100153507 - L244005421 - G-108



GLASS / VIDRIO / VERRE

Butech: Colorstuk Special Vanilla

Pcs	m2	Kg
30 x Cj	0,90 x Cj	17,67 x Cj
1080 x Pal	32,40 x Pal	636,34 x Pal



Urban Line Silver

30x10x0,8cm - 3 15/16"x11 3/4"x3/8"
100153509 - L244005471 - G-108



GLASS / VIDRIO / VERRE

Butech: Colorstuk Special Nacaré

Pcs	m2	Kg
30 x Cj	0,90 x Cj	17,67 x Cj
1080 x Pal	32,40 x Pal	636,34 x Pal



Urban Line Nickel

30x10x0,8cm - 3 15/16"x11 3/4"x3/8"
100153508 - L244005461 - G-108



GLASS / VIDRIO / VERRE

Butech: Colorstuk Special Moka

Pcs	m2	Kg
30 x Cj	0,90 x Cj	17,67 x Cj
1080 x Pal	32,40 x Pal	636,34 x Pal



Urban Line Zinc

30x10x0,8cm - 3 15/16"x11 3/4"x3/8"
100153510 - L244005441 - G-108



GLASS / VIDRIO / VERRE

Butech: Colorstuk Special Dark

Pcs	m2	Kg
30 x Cj	0,90 x Cj	17,67 x Cj
1080 x Pal	32,40 x Pal	636,34 x Pal



Urban Line Copper

30x10x0,8cm - 3 15/16"x11 3/4"x3/8"
100153505 - L244005451 - G-108



GLASS / VIDRIO / VERRE

Butech: Colorstuk Special Dark

Pcs	m2	Kg
30 x Cj	0,90 x Cj	17,67 x Cj
1080 x Pal	32,40 x Pal	636,34 x Pal

Urban



Urban Grey

7,5x30x0,8cm - 3"x11 3/4"x3/8"
100102717 - L241701951 - G-104



GLASS / VIDRIO / VERRE

Butech: Colorstuk Special Nacaré

Pcs	m2	Kg
10 x Cj	0,23 x Cj	4,66 x Cj
1920 x Pal	43,20 x Pal	894,72 x Pal



Urban Grey Frost

7,5x30x0,8cm - 3"x11 3/4"x3/8"
100102718 - L241701991 - G-104



GLASS / VIDRIO / VERRE

Butech: Colorstuk Special Nacaré

Pcs	m2	Kg
10 x Cj	0,23 x Cj	4,66 x Cj
1920 x Pal	43,20 x Pal	894,72 x Pal

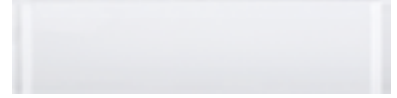

Urban White

7,5x30x0,8cm - 3"x11 3/4"x3/8"
100102719 - L241701981 - G-104



GLASS / VIDRIO / VERRE

Butech: Colorstuk Special White

Pcs	m2	Kg
10 x Cj	0,23 x Cj	4,66 x Cj
1920 x Pal	43,20 x Pal	894,72 x Pal



Urban White Frost

7,5x30x0,8cm - 3"x11 3/4"x3/8"
100102720 - L241701931 - G-104



GLASS / VIDRIO / VERRE

Butech: Colorstuk Special White

Pcs	m2	Kg
10 x Cj	0,23 x Cj	4,66 x Cj
1920 x Pal	43,20 x Pal	894,72 x Pal



Wall Coverings Urban White Frost

GLASS MOSAICS

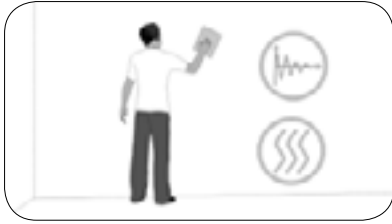

Smooth and solid, clean and dry surface.

Superficie lisa y consistente, además de seca y limpia.

Surface lisse et consistante ; elle doit aussi être sèche et propre.

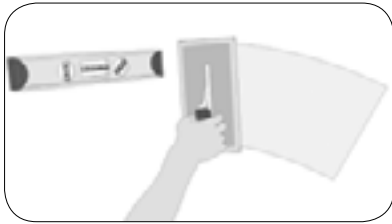

Level the surface in order to create a white background

Nivelar la superficie para crear un fondo blanco.

Niveler la surface pour créer un fond blanc.

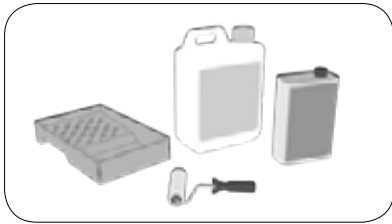

For levels greater than 2mm, we recommend the use of specific products.

En nivelados superiores a 2mm se recomienda el uso de productos específicos.

Pour des nivelages supérieurs à 2mm, l'usage de produits spécifiques est recommandé.



Room temperature between 5°C and 30°C

Temperatura ambiente entre 5°C y 30°C.

Température ambiante entre 5°C et 30°C.

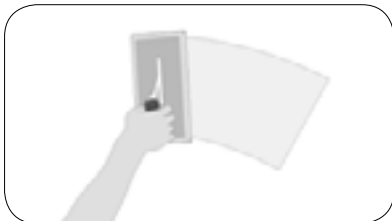

Extend the cement-based adhesive evenly on the wall with the flat side of a notched trowel. We recommend One-Flex by Butech.

Extender el adhesivo cementoso por el lado liso de una llana dentada uniformemente sobre el muro. Se recomienda One-Flex de Butech.

Étaler uniformément l'adhésif cimenteux sur le mur en utilisant le côté lisse d'une truelle à dents. Nous recommandons One-Flex de Butech.

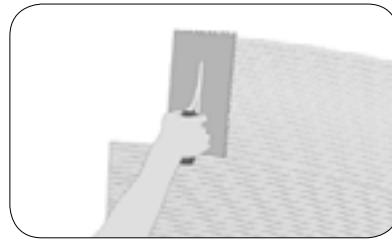

"Comb" the adhesive with the notched side (minimum notch 3mm.) Do not spread the cement-based adhesive over large areas to prevent it from drying before placing the material.

"Peinar" el adhesivo con el lado dentado (mínimo 3mm). No extender el cemento cola en grandes superficies para evitar que se reseque antes de colocar el material.

«Brosser» l'adhésif avec la face dentelée (minimum 3mm). Ne pas étaler le ciment-cola sur de grandes surfaces, afin d'éviter qu'il sèche avant la pose du matériel.

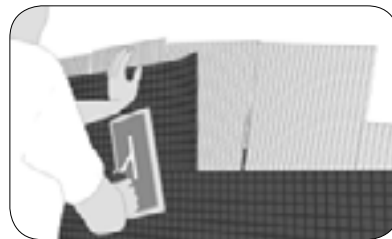

Lay the sheet and press evenly with a rubber trowel.

Colocar la hoja y presionar uniformemente con una llana de goma.

Placer la feuille et presser uniformément avec une truelle en caoutchouc.

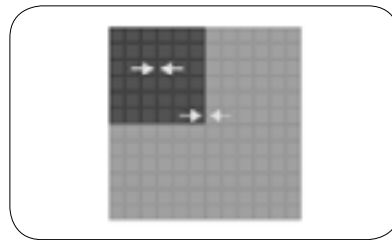

Ensure that the distance between the sheets is the same between pieces.

Asegurarse que la distancia entre hojas sea la misma entre las piezas.

Vérifiez que la distance entre les feuilles et la même que celle entre les pièces.

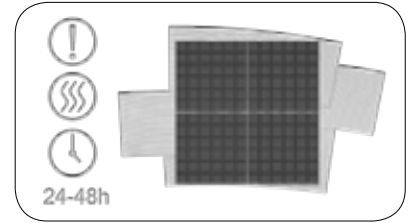

Let the adhesive dry for at least 24-48h. Before the adhesive dries, remove its remains with a sponge or cloth.

Dejar secar el adhesivo al menos 24-48h. Antes de que fragüe el adhesivo retirar los restos con una esponja o un trapo.

Laisser l'adhésif sécher pendant au moins 24 à 48h. Avant la prise de l'adhésif, retirer les restes à l'aide d'une éponge ou d'un chiffon.

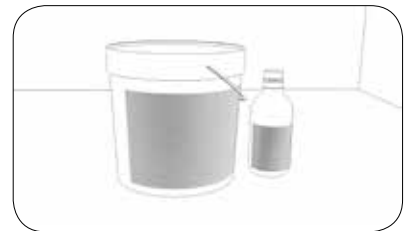

GROUTING (applicable only for mosaics with joint)

REJUNTADO (aplicable sólo para mosaicos con junta)

REJOINTOIEMENT (applicable uniquement pour les mosaïques posées avec joint)

Perfectly clean pieces, and free from dust residue before grouting.

Piezas perfectamente limpias y sin restos de residuos de polvo antes de proceder al rejuntado.

Pièces parfaitement propres et sans restes de poussière avant la phase de réalisation des joints.

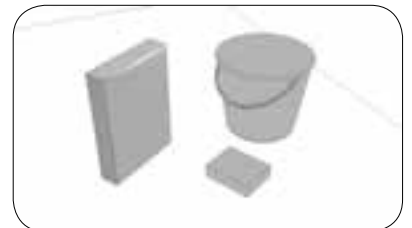

We recommend the use of Butech's Rapid Colorstuk.

Se recomienda el uso de Colorstuk Rapid de Butech.

L'utilisation de Colorstuk Rapid de Butech est recommandée.

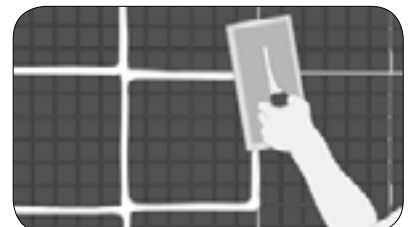

Installation / Instalación / Installation

Spread the material with a rubber trowel, filling joints well.

Extender el material con una llana de goma rellenando bien las juntas.

Étaler le matériel avec une truelle en caoutchouc en remplissant bien les joints.



Use the same trowel to remove excess grout.

Utilizar la misma llana para eliminar el exceso.

Utiliser la même truelle pour éliminer le produit excédant.

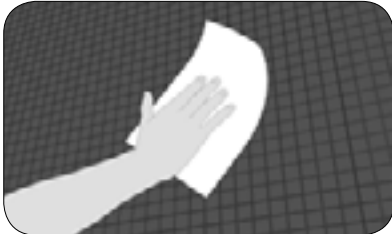

Remove material debris with a sponge or cloth before it hardens.

Antes de que fragüe el material, retirar los restos con una esponja o trapo.

Avant la prise du matériel, retirer les restes à l'aide d'une éponge ou d'un chiffon.

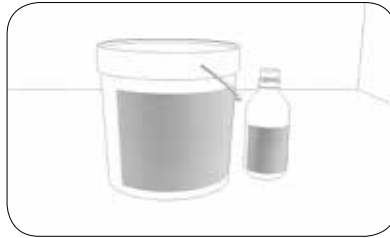

For installations where the material will be in contact with water (directly or indirectly,) we recommend the use of Butech's Epotech Aqua as grouting material.

Para instalaciones en las que el material esté en contacto con agua (directa o indirectamente) se recomienda el uso de Epotech Aqua de Butech como material de rejunte.

Pour des installations où le matériel est en contact avec de l'eau (directement ou indirectement), l'utilisation d'Epotech Aqua de Butech pour faire les joints est recommandée.

You can see these installation instructions, as well as maintenance instructions, updated and with more detail, by visiting our website www.anticcolonial.com

Puedes revisar estas instrucciones de instalación, así como las de mantenimiento, actualizadas y con más detalle visitando nuestra página web www.anticcolonial.com

Pour réviser ces instructions d'installation, ainsi que celles d'entretien, mises à jour et plus détaillées, veuillez visiter notre site Internet www.anticcolonial.com



HEXCUBE MOSAICS

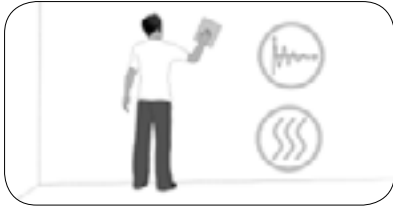

Smooth and solid, clean and dry surface.

Superficie lisa y consistente, además de seca y limpia.

Surface lisse et consistante ; elle doit aussi être sèche et propre.



Room temperature between 5°C and 30°C.

La temperatura ambiente entre 5°C y 30°C.

Température ambiante entre 5°C et 30°C.

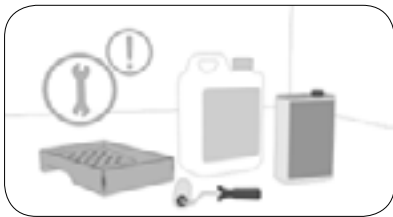

Prepare the bonding agent following the manufacturer's instructions. Apply the adhesive throughout the installation surface. We recommend Fr-One by Butech.

Preparar el material de agarre siguiendo las instrucciones del fabricante. Aplicar el adhesivo por toda la superficie de colocación. Recomendamos Fr-One de Butech.

Préparer le matériel de prise selon les instructions du fabricant. Appliquer l'adhésif sur toute la surface de pose. L'utilisation de Fr-One de Butech est recommandée.



Work in reduced areas in order to prevent it from drying out before installing the material.

Trabajar en zonas de extensión reducida para evitar que se reseque antes de colocar el material.

Travailler sur des zones réduites, afin d'éviter qu'il sèche avant la pose du matériel.

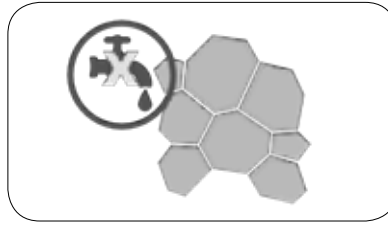

Do not wet the pieces before installing.

No mojar las piezas antes de colocarlas.

Ne pas mouiller les pièces avant la pose.



Extend the cement-based adhesive evenly on the wall with the flat side of a notched trowel.

Extender el adhesivo cementoso mediante el lado liso de una llana dentada uniformemente sobre el muro.

Étaler uniformément l'adhésif cimenteux sur le mur en utilisant le côté lisse d'une truelle à dents.

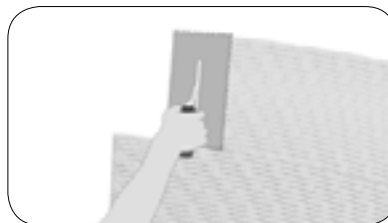

"Comb" the adhesive with the notched side (minimum notch 3mm.)
"Peinar" el adhesivo con el lado dentado (mínimo 3mm).

«Brosser» l'adhésif avec la face dentelée (minimum 3mm).

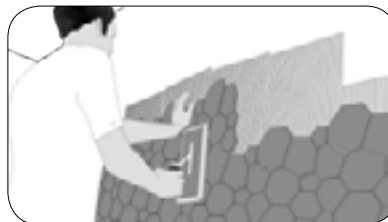

Lay the sheet and press evenly with a rubber trowel.

Colocar la hoja y presionar uniformemente con una llana de goma.

Placer la feuille et presser uniformément avec une truelle en caoutchouc.

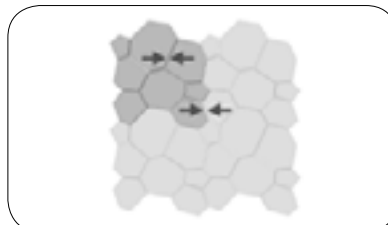

Ensure that the distance between the sheets is the same between pieces.

Asegurarse que la distancia entre hojas sea la misma que hay entre las piezas.

Vérifiez que la distance entre les feuilles et la même que celle entre les pièces.

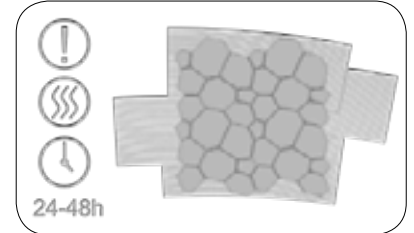

Let the adhesive dry for at least 24-48h. Before the adhesive dries, remove its remains with a sponge or cloth.

Dejar secar el adhesivo al menos 24-48h. Antes de que fragüe el adhesivo retirar los restos con una esponja o un trapo.

Laisser l'adhésif sécher pendant au moins 24 à 48h. Avant la prise de l'adhésif, retirer les restes à l'aide d'une éponge ou d'un chiffon.

IMPORTANT CONSIDERATIONS TO BEAR IN MIND

CONSIDERACIONES IMPORTANTES A TENER EN CUENTA

CONSIDÉRATIONS IMPORTANTES À PRENDRE EN COMPTE

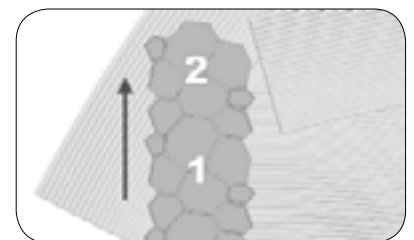

Install the meshes from the bottom up, paying attention to the direction of each mesh.

Instalar las mallas de abajo hacia arriba, tomando nota de la dirección de cada malla.

Installer les trames du bas vers le haut et noter la direction de chaque trame.

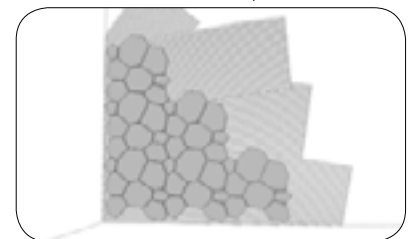

Cover the entire surface, leaving the corners and the inner angles.

Cubrir toda la superficie dejando las esquinas y los ángulos internos.

Couvrir toute la surface, sauf les coins et les angles internes.

Installation / Instalación / Installation

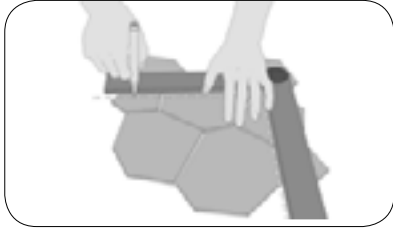

To achieve a straight cut for the inner angles and corners, mark the straight line on the mesh surface.

Para conseguir el corte recto para los ángulos internos y las esquinas marcar la línea recta en la superficie de la malla.

Pour obtenir une coupe droite pour les angles internes et les coins, marquez la ligne droite sur la surface de la trame.

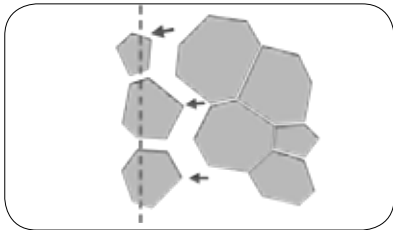

Remove each piece that needs to be cut.

Quitar cada pieza que se tiene que cortar.

Enlever chaque pièce qui doit être découpée.

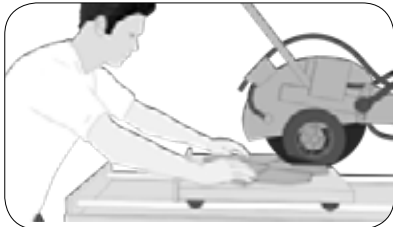

Cut using a diamond water jet cutting saw (do not cut more than two meshes at the same time.)

Cortar usando una sierra de diamante al corte de agua (no cortar más de dos mallas a la vez).

Les couper avec une scie à chaîne diamantée de découpe à l'eau (ne coupez pas plus de deux trames en même temps).

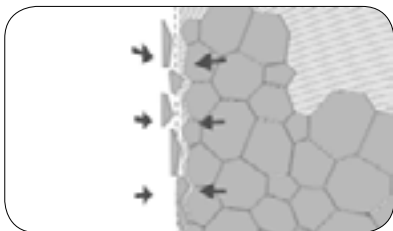

Glue the cut pieces to the mesh.

Pegar las piezas cortadas a la malla.

Coller les pièces découpées sur la trame.

GROUTING

REJUNTADO

REJOINTOEMENT

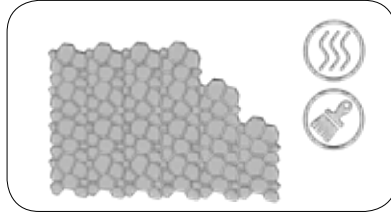

Perfectly clean pieces, and free from dust residue before grouting.

Piezas perfectamente limpias y sin restos de residuos de polvo antes de proceder al rejuntado.

Pièces parfaitement propres et sans poussière avant la phase de réalisation des joints.



We recommend the use of Butech's Epotech.

Se recomienda el uso de Epotech de Butech.

L'utilisation d'Epotech de Butech est recommandée.

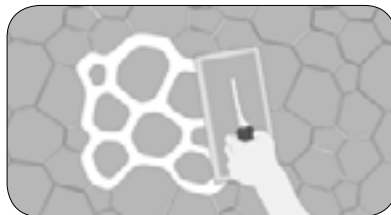

Spread the grouting material with a rubber trowel, filling joints well.

Extender el material de rejunte con una llana de goma rellenando bien las juntas.

Étaler le matériel avec une truelle en caoutchouc en remplissant bien les joints.



Use the same trowel to remove excess grout.

Utilizar la misma llana para eliminar el exceso.

Utiliser la même truelle pour éliminer le produit excédant.



Before the grouting material dries, remove its debris with a sponge or cloth.

Antes de que fragüe el material de rejunte, retirar los restos con una esponja o trapo.

Avant la prise du matériel, retirer les restes à l'aide d'une éponge ou d'un chiffon.

You can see these installation instructions, as well as maintenance instructions, updated and with more detail, by visiting our website www.anticcolonial.com

Puedes revisar estas instrucciones de instalación, así como las de mantenimiento, actualizadas y con más detalle visitando nuestra página web www.anticcolonial.com

Pour réviser ces instructions d'installation, ainsi que celles d'entretien, mises à jour et plus détaillées, veuillez visiter notre site Internet www.anticcolonial.com

GLASS TILES

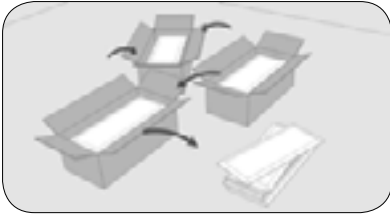

Mix pieces from different boxes to achieve a uniform look.

Mezclar piezas de varias cajas diferentes para conseguir un efecto estético homogéneo.

Mélanger les pièces de plusieurs boîtes différentes pour obtenir un effet esthétique homogène.

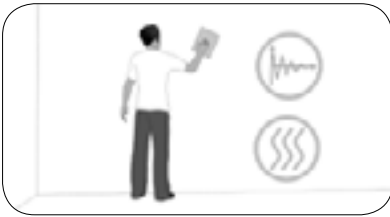

Smooth and solid, clean and dry surface.

Superficie lisa y consistente, además de seca y limpia.

Surface lisse et consistante ; elle doit aussi être sèche et propre.



Room temperature between 5°C and 30°C.

Temperatura ambiente entre 5°C y 30°C.

Température ambiante entre 5°C et 30°C.



Prepare the bonding agent following the manufacturer's instructions. Apply the adhesive throughout the installation surface. We recommend One-Flex by Butech.

Preparar el material de agarre siguiendo las instrucciones del fabricante. Aplicar el adhesivo por toda la superficie de colocación. Recomendamos One-Flex de Butech.

Préparer le matériel de prise selon les instructions du fabricant. Appliquer l'adhésif sur toute la surface de pose. Nous recommandons One-Flex de Butech.

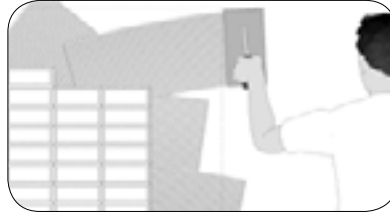

Work in reduced areas in order to prevent it from drying out before installing the material.

Trabajar en zonas de extensión reducida para evitar que se reseque antes de colocar el material.

Travailler sur des zones réduites, afin d'éviter qu'il sèche avant la pose du matériel.

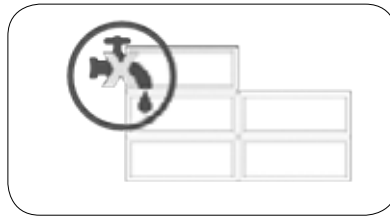

Do not wet the pieces before installing.

No mojar las piezas antes de colocarlas.

Ne pas mouiller les pièces avant la pose.

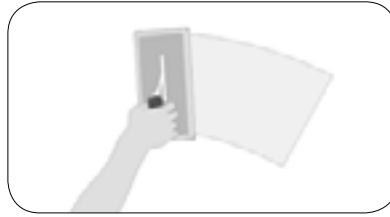

Extend the cement-based adhesive evenly on the wall with the flat side of a notched trowel.

Extender el adhesivo cementoso mediante el lado liso de una llana dentada uniformemente sobre el muro.

Étaler uniformément l'adhésif cimenteux sur le mur en utilisant le côté lisse d'une truelle à dents.

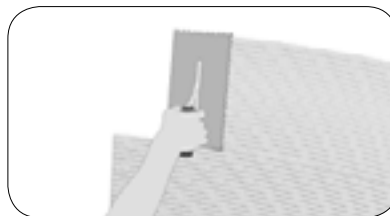

"Comb" the adhesive with the notched side (minimum notch 3 mm.)

"Peinar" el adhesivo con el lado dentado (mínimo 3mm).

«Brosser» l'adhésif avec la face dentelée (minimum 3mm).



Seal the movement joints.

Señalar las juntas de movimiento.

Marquer les joints de mouvement.

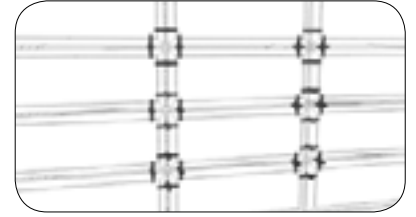

Leave the required joint using spacers, pressing and making a slight back and forth movement for greater coverage on the back.

Dejar la junta necesaria, con la ayuda de distanciadores, presionando y ejerciendo un pequeño movimiento de vaivén para una mayor cobertura del dorso.

Laisser le joint nécessaire, à l'aide des entretoises, en pressant et en exerçant un petit mouvement d'oscillation pour une plus grande couverture du revers.



Settle the pieces using a rigid and clean rubber plate, and beating on it with a rubber mallet.

Asentar las piezas empleando una plancha de goma rígida y limpia, batiendo sobre la misma con un martillo de goma.

Affaisser les pièces avec une planche en caoutchouc rigide et propre, en battant avec un marteau en caoutchouc.

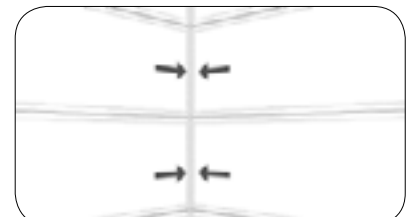

Take into account the perimeter joints at intersections and level changes.

Tener en cuenta las juntas perimetrales en los encuentros y cambios de plano.

Tenir compte des joints périphériques sur les rencontres et les changements de plan.

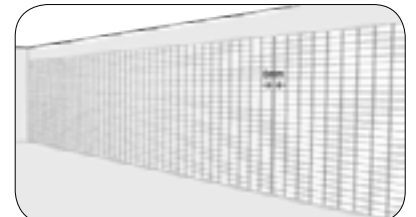

Arrange intermediate joints at least every 8m, with a minimum width of 6mm.

Installation / Instalación / Installation

Disponer juntas intermedias al menos cada 8m, teniendo una anchura mínima de 6mm.

Placer les joints intermédiaires tous les 8m, avec une largeur minimale de 6mm.

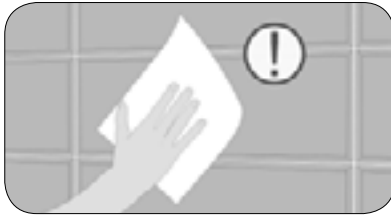

Clean excess adhesive that accumulates in the joint spaces when installing the pieces, before it hardens.

Limpiar el exceso de adhesivo que se acumula en los espacios de las juntas antes de que endurezca.

Nettoyer l'excédent d'adhésif qui reste aux espaces des joints avant son durcissement.

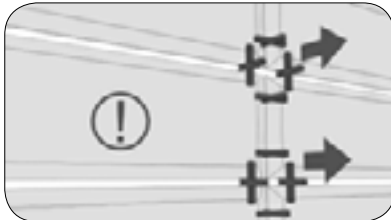

Remove the spacers before the adhesive hardens.

Retirar los distanciadores antes de que se endurezca el adhesivo.

Retirer les entretoises avant le durcissement de l'adhésif.

GROUTING

REJUNTADO

REJOINTOIEMENT

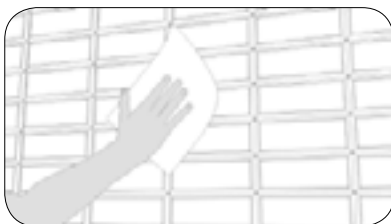

Perfectly clean pieces, and free from dust residue before grouting.

Piezas perfectamente limpias y sin restos de residuos de polvo antes de proceder al rejuntado.

Pièces parfaitement propres et sans poussière avant la phase de réalisation des joints.



We recommend the use of Colorstuk Rapid

Se recomienda el uso de Colorstuk Rapid.

L'utilisation de Colorstuk Rapid est recommandée.

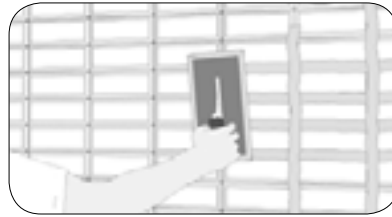

Spread the material with a rubber trowel, filling joints well.

Extender el material con una llana de goma rellenando bien las juntas.

Étaler le matériel avec une truelle en caoutchouc en remplissant bien les joints.

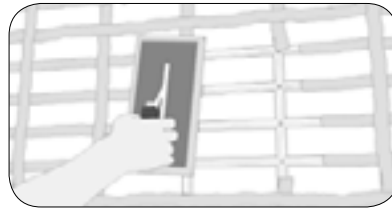

Use the same trowel to remove excess grout.

Utilizar la misma llana para eliminar el exceso.

Utiliser la même truelle pour éliminer le produit excédant.

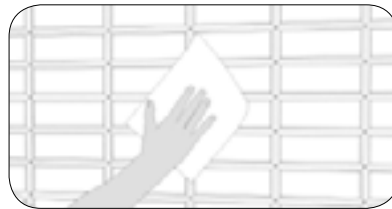

Before the material dries, remove its remains with a sponge or cloth.

Antes de que fragüe el material, retirar los restos con una esponja o trapo.

Avant la prise du matériel, retirer les excédents à l'aide d'une éponge ou d'un chiffon.



For installations where the material will be in contact with water (directly or indirectly,) we recommend the use of Butech's Epotech Aqua as grouting material.

Para instalaciones en las que el material esté en contacto con agua (directa o indirectamente) se recomienda el uso como material de rejunte de Epotech Aqua de Butech.

Pour des installations où le matériel est en contact avec de l'eau (directement ou indirectement), l'utilisation d'Epotech

Aqua de Butech pour faire les joints est recommandée.

CUTTING AND DRILLING

CORTE Y PERFORACIÓN

COUPE ET PERCEMENT

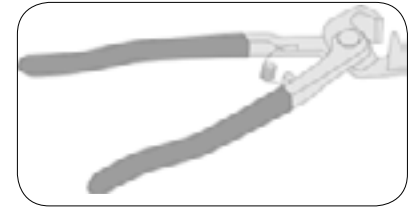

For small cuts and blunting, we recommend the Butech pliers for glass.

Para cortes pequeños y despuntados se recomienda las tenazas Butech para vidrio.

L'utilisation des tenailles Butech pour verre sont recommandés pour effectuer des petites découpes et des époutages.

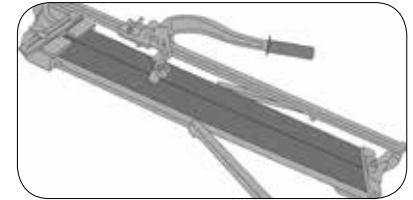

Dry cuts are carried out with the Sigma machine.

Los cortes en seco se realizan con la máquina Sigma.

Les découpes à sec sont effectuées avec la machine Sigma.

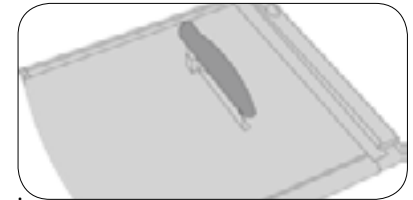

Cuts in full pieces shall be carried out with a water-cooled Butech cutting machine with diamond disk.

Los cortes en piezas enteras se realizan con una máquina de corte con disco de diamante Butech refrigerada por agua.

Les découpes en pièces entières sont effectuées avec une coupeuse avec un disque diamanté Butech réfrigérée à l'eau.

You can see these installation instructions, as well as maintenance instructions, updated and with more detail, by visiting our website www.anticcolonial.com

Puedes revisar estas instrucciones de instalación, así como las de mantenimiento, actualizadas y con más detalle visitando nuestra página web www.anticcolonial.com

Pour réviser ces instructions d'installation, ainsi que celles d'entretien, mises à jour et plus détaillées, veuillez visiter notre site Internet www.anticcolonial.com

Mix Mosaics

—
Imperia
Diverse
Tribal
Tecno
Eternity
Treasures
Fusion
Time
Aura
Trend
Worn
Elements
Art





Imperia Mix Silver Greys
1,5x1,5cm - 5/8"x5/8"

30,1x30,1x0,8cm - 11 3/4"x11 3/4"x3/8"
100092752 - L244000571 - G-126



ENAMELED TRAVERTINE / TRAVERTINO
ESMALTADO / TRAVERTIN ÉMAILLÉ
GLASS / VIDRIO / VERRE

Butech: Colorstuk Rapid Blanco

Pcs	m2	Kg
11 x Cj 594 x Pal	0,99 x Cj 53,82 x Pal	15,10 x Cj 815,56 x Pal



Imperia Mix Silver White
1,5x1,5cm - 5/8"x5/8"

29,8x29,8x0,8cm - 11 3/4"x11 3/4"x3/8"
100097070 - L242521601 - G-126



ENAMELED TRAVERTINE / TRAVERTINO
ESMALTADO / TRAVERTIN ÉMAILLÉ
GLASS / VIDRIO / VERRE

MARBLE / MÁRMOL / MARBRE
GLASS / VIDRIO / VERRE

Butech: Colorstuk Rapid Blanco

Pcs	m2	Kg
11 x Cj 594 x Pal	0,99 x Cj 52,75 x Pal	17,08 x Cj 922,48 x Pal



Imperia Onix Golden
1,5x1,5cm - 5/8"x5/8"

30x30x0,8cm - 11 3/4"x11 3/4"x3/8"
100092753 - L150901201 - G-118



ENAMELED TRAVERTINE / TRAVERTINO
ESMALTADO / TRAVERTIN ÉMAILLÉ
ONIX / ONIX / ONIX

Butech: Colorstuk Rapid Marfil

Pcs	m2	Kg
11 x Cj 594 x Pal	0,99 x Cj 53,46 x Pal	15,59 x Cj 842 x Pal



Imperia White
1,5x1,5cm - 5/8"x5/8"

30x30x0,8cm - 11 3/4"x11 3/4"x3/8"
100092754 - L242521481 - G-125



MARBLE / MÁRMOL / MARBRE
GLASS / VIDRIO / VERRE

Butech: Colorstuk Rapid Blanco

Pcs	m2	Kg
11 x Cj 594 x Pal	0,99 x Cj 53,46 x Pal	15,72 x Cj 849 x Pal



Imperia Nepal Bronze
1,5x1,5cm - 5/8"x5/8"

30x30x0,8cm - 11 3/4"x11 3/4"x3/8"
100092757 - L108012981 - G-118



SLATE / PIZARRA / ARDOISE
GLASS / VIDRIO / VERRE

Butech: Colorstuk Rapid Antracita

Pcs	m2	Kg
11 x Cj 594 x Pal	0,99 x Cj 53,46 x Pal	16,44 x Cj 888 x Pal



Imperia Bhutan Mirror
1,5x1,5cm - 5/8"x5/8"

30x30x0,8cm - 11 3/4"x11 3/4"x3/8"
100092747 - L108012951 - G-118



SLATE / PIZARRA / ARDOISE
GLASS / VIDRIO / VERRE

Butech: Colorstuk Rapid Antracita

Pcs	m2	Kg
11 x Cj 594 x Pal	0,99 x Cj 53,46 x Pal	15,85 x Cj 856 x Pal

Imperia



Imperia Caramel

1,5x1,5cm - 5/8"x5/8"

30x30x0,8cm - 11 3/4"x11 3/4"x3/8"

100092749 - L242521501 - G-125

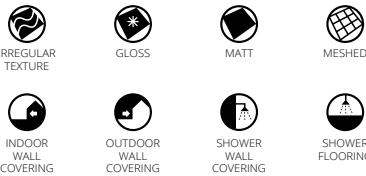

ENAMELED CERAMIC / CERÁMICA ESMALTADA /
CÉRAMIQUE ÉMAILLÉ
GLASS / VIDRIO / VERRE

Butech: Colorstuk Rapid Marrón

Pcs	m2	Kg
11 x Cj 594 x Pal	0,99 x Cj 53,46 x Pal	15,43 x Cj 833 x Pal



Imperia Greys

1,5x1,5cm - 5/8"x5/8"

30x30x0,8cm - 11 3/4"x11 3/4"x3/8"

100092750 - L242521471 - G-125



ENAMELED SLATE / PIZARRA ESMALTADA /
ARDOISE ÉMAILLÉ
GLASS / VIDRIO / VERRE

Butech: Colorstuk Rapid Gris

Pcs	m2	Kg
11 x Cj 594 x Pal	0,99 x Cj 53,46 x Pal	15,74 x Cj 850 x Pal



Imperia Mix Silver Blacks

1,5x1,5cm - 5/8"x5/8"

30,1x30,1x0,8cm - 11 3/4"x11 3/4"x3/8"

100092751 - L244000561 - G-126



ENAMELED TRAVERTINE / TRAVERTINO
ESMALTADO / TRAVERTIN ÉMAILLÉ
GLASS / VIDRIO / VERRE

Butech: Colorstuk Rapid Cemento

Pcs	m2	Kg
11 x Cj 594 x Pal	0,99 x Cj 53,82 x Pal	15,72 x Cj 849 x Pal



Imperia Mix Silver Blue Blacks

1,5x1,5cm - 5/8"x5/8"

29,8x29,8x0,8cm - 11 3/4"x11 3/4"x3/8"

100097069 - L242521611 - G-126

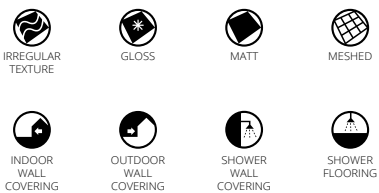

SLATE / PIZARRA / ARDOISE
GLASS / VIDRIO / VERRE

Butech: Colorstuk Rapid Antracita

Pcs	m2	Kg
11 x Cj 594 x Pal	0,98 x Cj 52,75 x Pal	17,08 x Cj 922,48 x Pal



Wall Coverings Imperia Mix Silver Blue Blacks

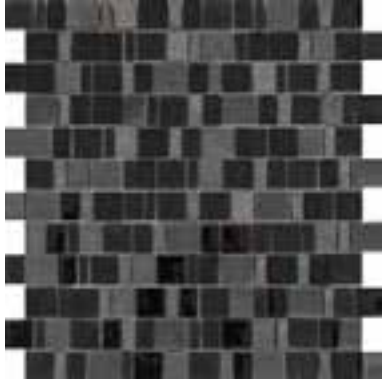

Diverse Black

30x28,5x0,8cm - 11 3/8"x11 1/4"x3/8"
100171113 - L244007051 - G-133



GRANITE / GRANITO / GRANITE
CERAMIC / CERÁMICA / CÉRAMIQUE
ENAMEL / ESMALTE / GLAZE

Butech: Colorstuk Rapid Antracita

Pcs	m2	Kg
11 x Cj	0,94 x Cj	17,08 x Cj
528 x Pal	45,14 x Pal	819,98 x Pal



Diverse Grey

30x28,5x0,8cm - 11 3/8"x11 1/4"x3/8"
100171114 - L244007041 - G-133



MARBLE / MÁRMOL / MARBRE
GLASS / VIDRIO / VERRE

Butech: Colorstuk Rapid Gris

Pcs	m2	Kg
11 x Cj	0,94 x Cj	17,08 x Cj
528 x Pal	45,14 x Pal	819,98 x Pal



Diverse White

30x28,5x0,8cm - 11 3/8"x11 1/4"x3/8"
100171079 - L244007031 - G-133



MARBLE / MÁRMOL / MARBRE
GLASS / VIDRIO / VERRE

Butech: Colorstuk Rapid Blanco

Pcs	m2	Kg
11 x Cj	0,94 x Cj	17,08 x Cj
528 x Pal	45,14 x Pal	819,98 x Pal



Wall Coverings Diverse Grey

Tribal



Tribal Pearl Black 1x2cm - 3/8"x3/4"

28,6x28,3x0,8cm - 11 1/4"x11 1/8"x3/8"
100112135 - L244001091 - G-136



GLASS / VIDRIO / VERRE
MOTHER OF PEARL / MADREPERLA / NACRE
MARBLE / MÁRMOL / MARBRE

Butech: Colorstuk Rapid Antracita

Pcs	m2	Kg
12 x Cj	0,97 x Cj	13,66 x Cj
576 x Pal	46,62 x Pal	655,49 x Pal



Tribal Pearl Brown 1x2cm - 3/8"x3/4"

28,6x28,3x0,8cm - 11 1/4"x11 1/8"x3/8"
100112136 - L244001141 - G-136



GLASS / VIDRIO / VERRE
MOTHER OF PEARL / MADREPERLA / NACRE
MARBLE / MÁRMOL / MARBRE

Butech: Colorstuk Special Moka

Pcs	m2	Kg
12 x Cj	0,97 x Cj	13,66 x Cj
576 x Pal	46,62 x Pal	655,49 x Pal



Tribal Pearl White 1x2cm - 3/8"x3/4"

28,6x28,3x0,8cm - 11 1/4"x11 1/8"x3/8"
100112137 - L244001101 - G-139



GLASS / VIDRIO / VERRE
MOTHER OF PEARL / MADREPERLA / NACRE
MARBLE / MÁRMOL / MARBRE

Butech: Colorstuk Special Nacaré

Pcs	m2	Kg
12 x Cj	0,97 x Cj	13,66 x Cj
576 x Pal	46,62 x Pal	655,49 x Pal

STOCK



Wall Coverings Tribal Pearl Brown

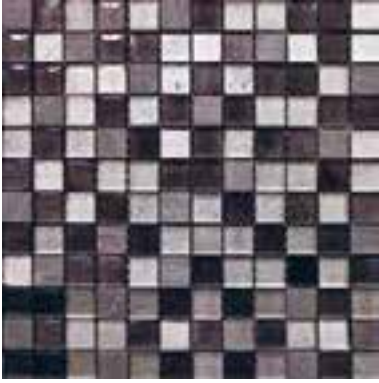

Tecno Bhutan Silver Glass
2,3x2,3cm - 7/8"x7/8"

30x30x0,8cm - 11 3/4"x11 3/4"x3/8"
100092759 - L242521531 - G-126



GLASS / VIDRIO / VERRE
SLATE / PIZARRA / ARDOISE

Butech: Colorstuk Rapid Antracita

Pcs	m2	Kg
11 x Cj 594 x Pal	0,99 x Cj 53,46 x Pal	17,04 x Cj 920 x Pal



Tecno Nepal Golden Glass
2,3x2,3cm - 7/8"x7/8"

30x30x0,8cm - 11 3/4"x11 3/4"x3/8"
100092762 - L242521521 - G-126



GLASS / VIDRIO / VERRE
SLATE / PIZARRA / ARDOISE

Butech: Colorstuk Rapid Cemento

Pcs	m2	Kg
11 x Cj 594 x Pal	0,99 x Cj 53,46 x Pal	17,07 x Cj 922 x Pal

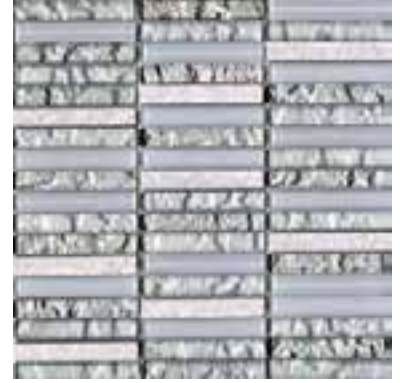

Tecno Linear Silver White

29,8x30,5x0,8cm - 12"x11 3/4"x3/8"
100097088 - L242521831 - G-125



GLASS / VIDRIO / VERRE
QUARTZITE / CUARCITA / QUARTZITE

Butech: Colorstuk Rapid Blanco

Pcs	m2	Kg
11 x Cj 594 x Pal	1 x Cj 53,99 x Pal	17,38 x Cj 938,52 x Pal



Tecno Br. Bhutan Silver Glass
2,3x7,3cm - 7/8"x2 7/8"

30x30x0,8cm - 11 3/4"x11 3/4"x3/8"
100092760 - L242521511 - G-125



GLASS / VIDRIO / VERRE
SLATE / PIZARRA / ARDOISE

Butech: Colorstuk Rapid Antracita

Pcs	m2	Kg
11 x Cj 594 x Pal	0,87 x Cj 46,78 x Pal	15,91 x Cj 859 x Pal



Tecno Br. Nepal Golden Glass
2,3x7,3cm - 7/8"x2 7/8"

30x30x0,8cm - 11 3/4"x11 3/4"x3/8"
100092761 - L242521541 - G-125



GLASS / VIDRIO / VERRE
SLATE / PIZARRA / ARDOISE

Butech: Colorstuk Rapid Cemento

Pcs	m2	Kg
11 x Cj 594 x Pal	0,87 x Cj 46,78 x Pal	15,96 x Cj 862 x Pal



Tecno Nepal Decor
2,3x2,3cm - 7/8"x7/8"

29,8x29,8x0,8cm - 11 3/4"x11 3/4"x3/8"
100088511 - L108010901 - G-125



SLATE / PIZARRA / ARDOISE

Butech: Colorstuk Rapid Cemento

Pcs	m2	Kg
11 x Cj 594 x Pal	0,99 x Cj 53,46 x Pal	14,06 x Cj 759,13 x Pal

Tecno

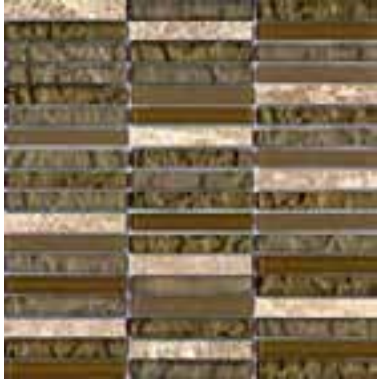

Tecno Linear Brown Capuccino

29,8x30,5x0,8cm - 12"x11 3/4"x3/8"
100097086 - L242521861 - G-125



GLASS / VIDRIO / VERRE
QUARTZITE / CUARCITA / QUARTZITE

Butech: Colorstuk Rapid Marfil

Pcs	m2	Kg
11 x Cj	1 x Cj	17,38 x Cj
594 x Pal	53,99 x Pal	938,52 x Pal



Tecno Linear Cream Capuccino

29,8x30,5x0,8cm - 12"x11 3/4"x3/8"
100097090 - L242521841 - G-125



GLASS / VIDRIO / VERRE
QUARTZITE / CUARCITA / QUARTZITE

Butech: Colorstuk Rapid Marfil

Pcs	m2	Kg
11 x Cj	1 x Cj	17,38 x Cj
594 x Pal	53,99 x Pal	938,52 x Pal

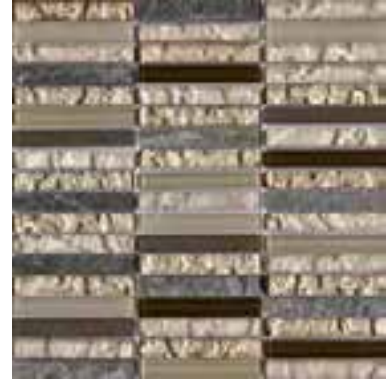

Tecno Linear Cream Habana

29,8x30,5x0,8cm - 12"x11 3/4"x3/8"
100097087 - L242521851 - G-125



GLASS / VIDRIO / VERRE
QUARTZITE / CUARCITA / QUARTZITE

Butech: Colorstuk Rapid Marfil

Pcs	m2	Kg
11 x Cj	1 x Cj	17,38 x Cj
594 x Pal	53,99 x Pal	938,52 x Pal

Mosaics



Tecno Glass Country 2,1x2,1cm - 7/8"x7/8"

29,6x29,6x0,8cm - 11 5/8"x 11 5/8" x3/8"
100097093 - L242521741 - G-125



GLASS / VIDRIO / VERRE
ENAMELED SLATE / PIZARRA ESMALTADA /
ARDOISE ÉMAILLÉ

Butech: Colorstuk Rapid Beige

Pcs	m2	Kg
11 x Cj	0,96 x Cj	16,25 x Cj
594 x Pal	52,04 x Pal	877,34 x Pal



Tecno Quarz Emerald 2,1x2,1cm - 7/8"x7/8"

29,6x29,6x0,8cm - 11 5/8"x 11 5/8" x3/8"
100097095 - L242521731 - G-133



GLASS / VIDRIO / VERRE
QUARTZITE / CUARCITA / QUARTZITE

Butech: Colorstuk Rapid Blanco

Pcs	m2	Kg
11 x Cj	0,96 x Cj	16,25 x Cj
594 x Pal	52,04 x Pal	877,34 x Pal



Tecno Quarz Mountain 2,1x2,1cm - 7/8"x7/8"

29,6x29,6x0,8cm - 11 5/8"x 11 5/8" x3/8"
100097089 - L242521691 - G-125



GLASS / VIDRIO / VERRE
QUARTZITE / CUARCITA / QUARTZITE

Butech: Colorstuk Rapid Blanco

Pcs	m2	Kg
11 x Cj	0,96 x Cj	16,25 x Cj
594 x Pal	52,04 x Pal	877,34 x Pal

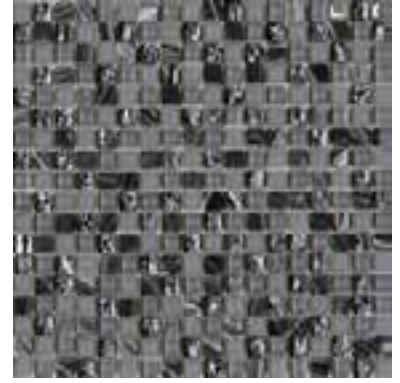
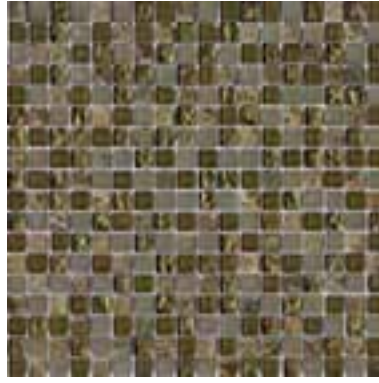

Eternity Cream

1,5x1,5cm - 5/8"x5/8"

29,7x29,7x0,8cm - 11 3/4"x 11 3/4"x3/8"
100097100 - L242521791 - G-134



GLASS / VIDRIO / VERRE
MARBLE / MÁRMOL / MARBRE

Butech: Colorstuk Rapid Marfil

Pcs	m2	Kg
10 x Cj 600 x Pal	0,88 x Cj 52,92 x Pal	15,01 x Cj 900,60 x Pal



Eternity Emperador

1,5x1,5cm - 5/8"x5/8"

29,7x29,7x0,8cm - 11 3/4"x 11 3/4"x3/8"
100097101 - L242521811 - G-134



GLASS / VIDRIO / VERRE
MARBLE / MÁRMOL / MARBRE

Butech: Colorstuk Rapid Beige

Pcs	m2	Kg
10 x Cj 600 x Pal	0,88 x Cj 52,92 x Pal	15,01 x Cj 900,60 x Pal

Eternity Grey

1,5x1,5cm - 5/8"x5/8"

29,7x29,7x0,8cm - 11 3/4"x 11 3/4"x3/8"
100097102 - L242521771 - G-134



GLASS / VIDRIO / VERRE
MARBLE / MÁRMOL / MARBRE

Butech: Colorstuk Rapid Gris

Pcs	m2	Kg
10 x Cj 600 x Pal	0,88 x Cj 52,92 x Pal	15,01 x Cj 900,60 x Pal



Eternity Mini Strip Cream

29,8x30,5x0,8cm - 11 3/4"x 11 3/4"x3/8"
100097103 - L242521821 - G-134



GLASS / VIDRIO / VERRE
MARBLE / MÁRMOL / MARBRE

Butech: Colorstuk Rapid Marfil

Pcs	m2	Kg
5 x Cj 360 x Pal	0,44 x Cj 31,75 x Pal	8,02 x Cj 577,44 x Pal

Eternity Mini Strip Emperador

29,8x30,5x0,8cm - 11 3/4"x 11 3/4"x3/8"
100097104 - L242521751 - G-134

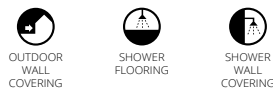

GLASS / VIDRIO / VERRE
MARBLE / MÁRMOL / MARBRE

Butech: Colorstuk Rapid Marfil

Pcs	m2	Kg
5 x Cj 360 x Pal	0,44 x Cj 31,75 x Pal	8,02 x Cj 577,44 x Pal



Eternity Mini Strip Grey

29,8x30,5x0,8cm - 11 3/4"x 11 3/4"x3/8"
100097105 - L242521801 - G-134



GLASS / VIDRIO / VERRE
MARBLE / MÁRMOL / MARBRE

Butech: Colorstuk Rapid Marfil

Pcs	m2	Kg
5 x Cj 360 x Pal	0,44 x Cj 31,75 x Pal	8,02 x Cj 577,44 x Pal



Eternity



Eternity White

1,5x1,5cm - 5/8"x5/8"

29,7x29,7x0,8cm - 11 3/4"x 11 3/4"x3/8"

100097107 - L242521781 - G-134



GLOSS



MATT



MESHED



INDOOR
WALL
COVERING



OUTDOOR
WALL
COVERING



SHOWER
FLOORING



SHOWER
WALL
COVERING

GLASS / VIDRIO / VERRE
MARBLE / MÁRMOL / MARBRE

Butech: Colorstuk Rapid Blanco

Pcs	m2	Kg
10 x Cj	0,88 x Cj	15,01 x Cj
600 x Pal	52,92 x Pal	900,60 x Pal

• STOCK



Eternity Mini Strip White

29,8x30,5x0,8cm - 11 3/4"x 11 3/4"x3/8"

100097106 - L242521761 - G-134



GLOSS



MATT



MESHED



INDOOR
WALL
COVERING



OUTDOOR
WALL
COVERING



SHOWER
FLOORING



SHOWER
WALL
COVERING

GLASS / VIDRIO / VERRE
MARBLE / MÁRMOL / MARBRE

Butech: Colorstuk Rapid Blanco

Pcs	m2	Kg
5 x Cj	0,44 x Cj	8,02 x Cj
360 x Pal	31,75 x Pal	577,44 x Pal

• STOCK



Wall Coverings Eternity Grey



Treasures Bronz. Emper.
1,5x1,5cm - 5/8"x5/8"

30,1x30,1x0,8cm - 11 7/8"x11 7/8"x3/8"
100103970 - L244000941 - G-135

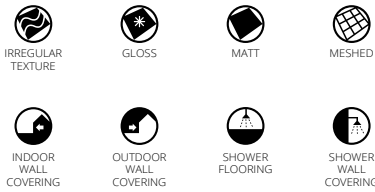

MARBLE / MÁRMOL / MARBRE
GLASS / VIDRIO / VERRE

Butech: Colorstuk Rapid Antracita

Pcs	m2	Kg
11 x Cj 528 x Pal	1 x Cj 47,84 x Pal	16,15 x Cj 775 x Pal



Treasures Bronz. Emper.
1,2x2cm - 1/2"x3/4"

29,8x30,6x0,8cm - 11 3/4"x12"x3/8"
100104001 - L242601681 - G-135

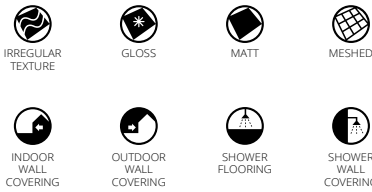

MARBLE / MÁRMOL / MARBRE
GLASS / VIDRIO / VERRE

Butech: Colorstuk Rapid Antracita

Pcs	m2	Kg
11 x Cj 528 x Pal	1 x Cj 48,15 x Pal	17,08 x Cj 819,98 x Pal



Treasures Bronz. Emper. Strip

29,2x30,4x0,8cm - 11 1/2"x12"x3/8"
100104000 - L244000961 - G-135

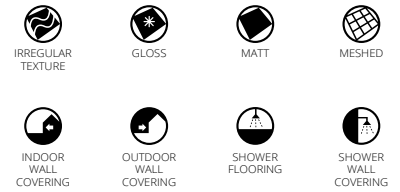

MARBLE / MÁRMOL / MARBRE
GLASS / VIDRIO / VERRE

Butech: Colorstuk Rapid Antracita

Pcs	m2	Kg
11 x Cj 528 x Pal	0,98 x Cj 46,87 x Pal	17,64 x Cj 846,91 x Pal



Treasures Bronz. Emper. Moon

19x29x0,8cm - 7 1/2"x11 3/8"x3/8"
100103999 - L240900091 - G-126

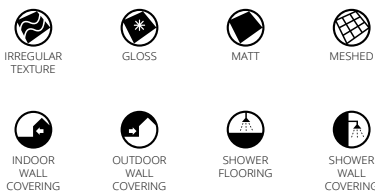

MARBLE / MÁRMOL / MARBRE
GLASS / VIDRIO / VERRE

Butech: Colorstuk Rapid Antracita

Pcs	m2	Kg
11 x Cj 792 x Pal	0,70 x Cj 50,17 x Pal	11,39 x Cj 819,72 x Pal



Wall Coverings Treasures Bronze Emperador (1,5)

Treasures



Treasures Mist Shannan

1,5x1,5cm - 5/8"x5/8"

30,1x30,1x0,8cm - 11 7/8"x11 7/8"x3/8"
100103971 - L244000921 - G-135

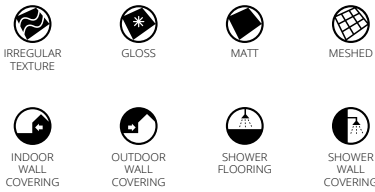

QUARTZITE / CUARCITA / QUARTZITES
GLASS / VIDRIO / VERRE

Butech: Colorstuk Rapid Gris

Pcs	m2	Kg
11 x Cj 528 x Pal	1 x Cj 47,84 x Pal	16,21 x Cj 778 x Pal



Treasures Mist Shannan

1,2x2cm - 1/2"x3/4"

29,8x30,6x0,8cm - 11 3/4"x12"x3/8"
100103974 - L242601671 - G-135

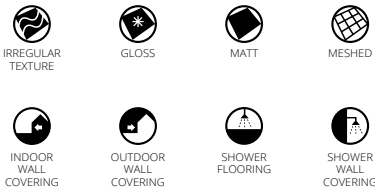

QUARTZITE / CUARCITA / QUARTZITES
GLASS / VIDRIO / VERRE

Butech: Colorstuk Rapid Gris

Pcs	m2	Kg
11 x Cj 528 x Pal	1 x Cj 48,15 x Pal	17,08 x Cj 819,98 x Pal



Treasures Mist Shannan Strip

29,2x30,4x0,8cm - 11 1/2"x12"x3/8"
100103973 - L244000911 - G-135

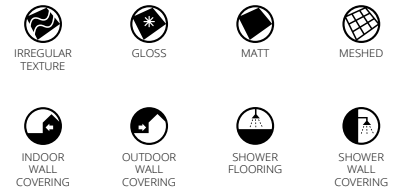

QUARTZITE / CUARCITA / QUARTZITES
GLASS / VIDRIO / VERRE

Butech: Colorstuk Rapid Gris

Pcs	m2	Kg
11 x Cj 528 x Pal	0,98 x Cj 46,87 x Pal	17,64 x Cj 846,91 x Pal



Treasures Mist Shannan Moon

19x29x0,8cm - 7 1/2"x11 3/8"x3/8"
100103972 - L240900071 - G-135

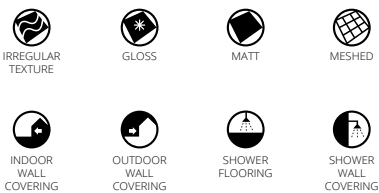

QUARTZITE / CUARCITA / QUARTZITES
GLASS / VIDRIO / VERRE

Butech: Colorstuk Rapid Gris

Pcs	m2	Kg
11 x Cj 792 x Pal	0,70 x Cj 50,17 x Pal	11,39 x Cj 819,72 x Pal

STOCK



Wall Coverings Treasures Mist Shannan Moon



Fusion Brick 3D White

29,6x30x0,8-1,3cm - 11 5/8"x11 3/4"x3/8"-1/2"
100115537 - L241707991 - G-148



GLASS / VIDRIO / VERRE
METAL / METAL / MÉTAL

No supported grouting / No admite rejuntado /
Ne peut pas être jointoyé.

Pcs	m2	Kg
8 x Cj 384 x Pal	0,72 x Cj 34,56 x Pal	12,08 x Cj 579,84 x Pal



Fusion Brick 3D Caramel
Mix

29,6x30x0,8-1,3cm - 11 5/8"x11 3/4"x3/8"-1/2"
100115534 - L241707871 - G-148



GLASS / VIDRIO / VERRE
METAL / METAL / MÉTAL

No supported grouting / No admite rejuntado /
Ne peut pas être jointoyé.

Pcs	m2	Kg
8 x Cj 384 x Pal	0,72 x Cj 34,56 x Pal	12,08 x Cj 579,84 x Pal



Fusion Brick 3D Steel Mix

29,6x30x0,8-1,3cm - 11 5/8"x11 3/4"x3/8"-1/2"
100115536 - L241707941 - G-148



GLASS / VIDRIO / VERRE
METAL / METAL / MÉTAL

No supported grouting / No admite rejuntado /
Ne peut pas être jointoyé.

Pcs	m2	Kg
8 x Cj 384 x Pal	0,72 x Cj 34,56 x Pal	12,08 x Cj 579,84 x Pal



Fusion Mini Strip White

30x30x0,8cm - 11 3/4"x11 3/4"x3/8"
100115547 - L241707901 - G-136



GLASS / VIDRIO / VERRE
METAL / METAL / MÉTAL

Butech: colorstuk 0-4 Gris

Pcs	m2	Kg
11 x Cj 528 x Pal	0,99 x Cj 47,52 x Pal	15,62 x Cj 749,76 x Pal



Fusion Mini Strip Caramel
Mix

30x30x0,8cm - 11 3/4"x11 3/4"x3/8"
100115544 - L241707971 - G-136



GLASS / VIDRIO / VERRE
METAL / METAL / MÉTAL

Butech: colorstuk 0-4 Cemento

Pcs	m2	Kg
11 x Cj 528 x Pal	0,99 x Cj 47,52 x Pal	15,62 x Cj 749,76 x Pal



Fusion Mini Strip Steel Mix

30x30x0,8cm - 11 3/4"x11 3/4"x3/8"
100115546 - L241707961 - G-136



GLASS / VIDRIO / VERRE
METAL / METAL / MÉTAL

Butech: colorstuk 0-4 Cemento

Pcs	m2	Kg
11 x Cj 528 x Pal	0,99 x Cj 47,52 x Pal	15,62 x Cj 749,76 x Pal

Fusion



Fusion Hexagon Caramel Mix

29,5x25,5x0,8cm - 11 5/8"x10"x3/8"
100153565 - L241711091 - G-140



GLASS / VIDRIO / VERRE
METAL / METAL / MÉTAL

Butech: colorstuk 0-4 Cemento

Pcs	m2	Kg
11 x Cj 528 x Pal	0,83 x Cj 39,70 x Pal	12,12 x Cj 581,85 x Pal



Fusion Hexagon Steel Mix

29,5x25,5x0,8cm - 11 5/8"x10"x3/8"
100153566 - L241711101 - G-140



GLASS / VIDRIO / VERRE
METAL / METAL / MÉTAL

Butech: colorstuk 0-4 Cemento

Pcs	m2	Kg
11 x Cj 528 x Pal	0,83 x Cj 39,70 x Pal	12,12 x Cj 581,85 x Pal



Fusion Hexagon White

29,5x25,5x0,8cm - 11 5/8"x10"x3/8"
100153536 - L241711021 - G-140



GLASS / VIDRIO / VERRE
METAL / METAL / MÉTAL

Butech: colorstuk 0-4 Gris

Pcs	m2	Kg
11 x Cj 528 x Pal	0,83 x Cj 39,70 x Pal	12,12 x Cj 581,85 x Pal



Fusion 3D Steel Mix

29,2x30x0,8-1,1cm - 11 1/2"x11 3/4"x3/8"-1/2"
100115531 - L241707831 - G-148



GLASS / VIDRIO / VERRE
METAL / METAL / MÉTAL

No supported grouting / No admite rejuntado /
Ne peut pas être jointoyé.

Pcs	m2	Kg
8 x Cj 384 x Pal	0,72 x Cj 34,56 x Pal	12,08 x Cj 579,84 x Pal



Fusion 3D Caramel Mix

29,2x30x0,8-1,1cm - 11 1/2"x11 3/4"x3/8"-1/2"
100115529 - L241707821 - G-148



GLASS / VIDRIO / VERRE
METAL / METAL / MÉTAL

No supported grouting / No admite rejuntado /
Ne peut pas être jointoyé.

Pcs	m2	Kg
8 x Cj 384 x Pal	0,72 x Cj 34,56 x Pal	12,08 x Cj 579,84 x Pal

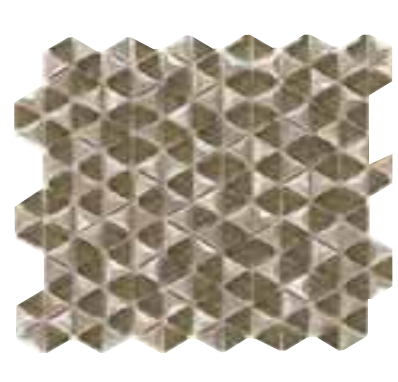

Fusion Triangles Caramel

27x31x0,8cm - 10 5/8"x12 1/4"x3/8"
100179438 - L241714291 - G-140



GLASS / VIDRIO / VERRE
METAL / METAL / MÉTAL

Butech: colorstuk 0-4 Cemento

Pcs	m2	Kg
11 x Cj 528 x Pal	0,92 x Cj 44,19 x Pal	8,8 x Cj 422,4 x Pal



Time Texture Cream
2,3x2,7cm - 7/8"x 1 1/8"

29,6x28,6x0,8cm - 11 5/8"x11 1/4"x3/8"
100135772 - L241709561 - G-124

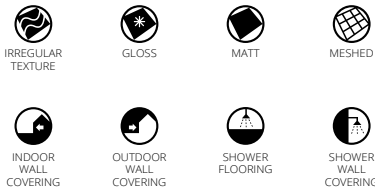

MARBLE / MÁRMOL / MARBRE
GLASS / VIDRIO / VERRE

Butech: Colorstuk Rapid Beige

Pcs	m2	Kg
10 x Cj 360 x Pal	0,84 x Cj 30,47 x Pal	15,13 x Cj 544,68 x Pal



Time Text. Silver Wood
2,3x2,7cm - 7/8"x 1 1/8"

29,6x28,6x0,8cm - 11 5/8"x11 1/4"x3/8"
100135771 - L241709481 - G-124

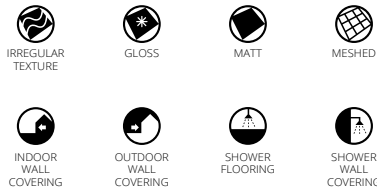

TRAVERTINE / TRAVERTINO / TRAVERTIN
GLASS / VIDRIO / VERRE

Butech: Colorstuk Rapid Cemento

Pcs	m2	Kg
10 x Cj 360 x Pal	0,84 x Cj 30,47 x Pal	15,13 x Cj 544,68 x Pal



Time Text. Silk Wood
2,3x2,7cm - 7/8"x 1 1/8"

29,6x28,6x0,8cm - 11 5/8"x11 1/4"x3/8"
100135770 - L241709471 - G-124

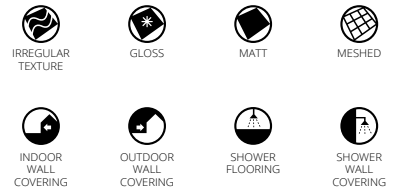

TRAVERTINE / TRAVERTINO / TRAVERTIN
GLASS / VIDRIO / VERRE

Butech: Colorstuk Rapid Gris

Pcs	m2	Kg
10 x Cj 360 x Pal	0,84 x Cj 30,47 x Pal	15,13 x Cj 544,68 x Pal



Time Text. Linear Cream
1,5x10cm - 5/8"x 3 7/8"

30x30x0,8cm - 11 3/4"x11 3/4"x3/8"
100135767 - L241709521 - G-124

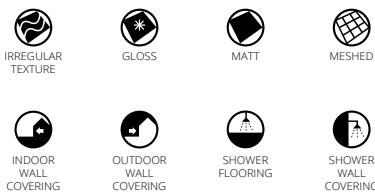

MARBLE / MÁRMOL / MARBRE
GLASS / VIDRIO / VERRE

Butech: Colorstuk Rapid Beige

Pcs	m2	Kg
10 x Cj 360 x Pal	0,90 x Cj 32,40 x Pal	15,13 x Cj 544,68 x Pal



Time Text. Linear Silver Wood
1,5x10cm - 5/8"x 3 7/8"

30x30x0,8cm - 11 3/4"x11 3/4"x3/8"
100135769 - L241709501 - G-124

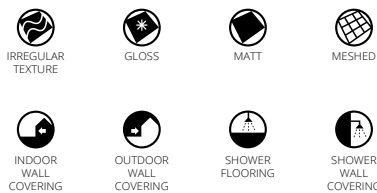

TRAVERTINE / TRAVERTINO / TRAVERTIN
GLASS / VIDRIO / VERRE

Butech: Colorstuk Rapid Cemento

Pcs	m2	Kg
10 x Cj 360 x Pal	0,90 x Cj 32,40 x Pal	15,13 x Cj 544,68 x Pal



Time Text. Linear Silk Wood
1,5x10cm - 5/8"x 3 7/8"

30x30x0,8cm - 11 3/4"x11 3/4"x3/8"
100135768 - L241709551 - G-124

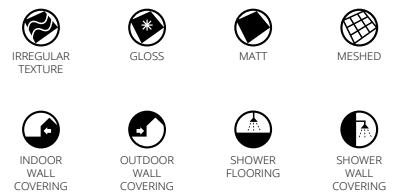

TRAVERTINE / TRAVERTINO / TRAVERTIN
GLASS / VIDRIO / VERRE

Butech: Colorstuk Rapid Gris

Pcs	m2	Kg
10 x Cj 360 x Pal	0,90 x Cj 32,40 x Pal	15,13 x Cj 544,68 x Pal

Aura



Aura Hexagon Whites

29x30x0,8cm - 11 3/8"x11 3/4"x3/8"
100160530 - L244006201 - G-135



MARBLE / MÁRMOL / MARBRE
GLASS / VIDRIO / VERRE

Butech: Colorstuk Rapid Blanco

Pcs	m2	Kg
11 x Cj	0,95 x Cj	15,36 x Cj
528 x Pal	45,93 x Pal	737,61 x Pal



Aura Hexagon Creams

29x30x0,8cm - 11 3/8"x11 3/4"x3/8"
100160449 - L244006231 - G-135



MARBLE / MÁRMOL / MARBRE
GLASS / VIDRIO / VERRE

Butech: Colorstuk Rapid Beige

Pcs	m2	Kg
11 x Cj	0,95 x Cj	15,36 x Cj
528 x Pal	45,93 x Pal	737,61 x Pal

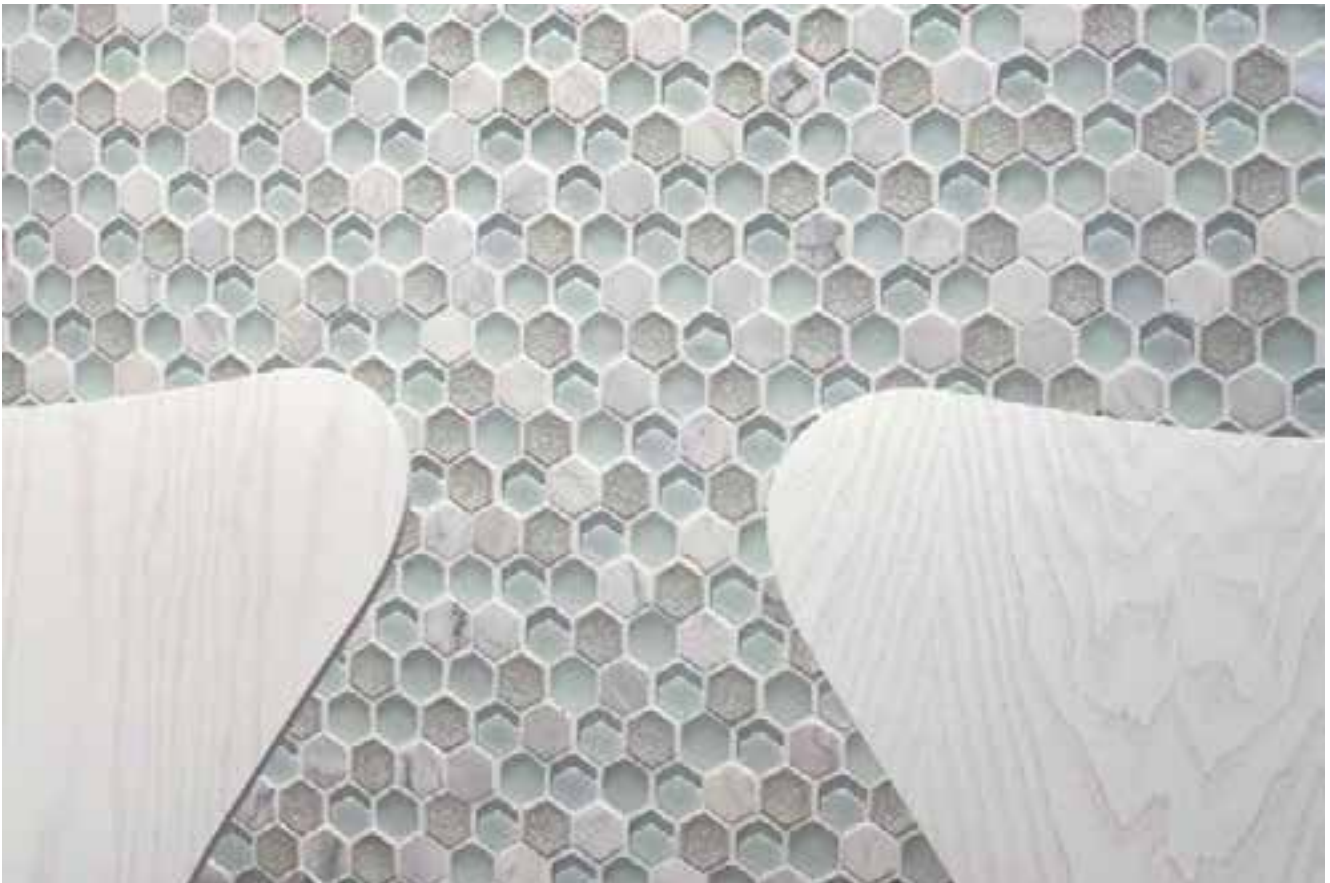

Wall Coverings Aura Hexagon Whites



Trend Stripes Greys

29,5x29,7x0,8cm - 11 5/8"x11 3/4"x3/8"
100179407 - L241714351 - G-124



GLOSS



MESHED



INDOOR
WALL
COVERING

TRAVERTINE / TRAVERTINO / TRAVERTIN
GLASS / VIDRIO / VERRE
METAL / METAL / MÉTAL

Butech: Colorstuk 0-4 Gris

Pcs	m2	Kg
10 x Cj	1,014 x Cj	8 x Cj
600 x Pal	60,84 x Pal	480 x Pal



Trend Stripes Browns

29,5x29,7x0,8cm - 11 5/8"x11 3/4"x3/8"
100179423 - L241714331 - G-124



GLOSS



MESHED



INDOOR
WALL
COVERING

MARBLE / MÁRMOL / MARBRE
GLASS / VIDRIO / VERRE
METAL / METAL / MÉTAL

Butech: Colorstuk 0-4 Moka

Pcs	m2	Kg
10 x Cj	1,014 x Cj	8 x Cj
600 x Pal	60,84 x Pal	480 x Pal



Trend Stripes Whites

29,5x29,7x0,8cm - 11 5/8"x11 3/4"x3/8"
100179424 - L241714311 - G-124



GLOSS



MESHED



INDOOR
WALL
COVERING

MARBLE / MÁRMOL / MARBRE
GLASS / VIDRIO / VERRE
METAL / METAL / MÉTAL

Butech: Colorstuk 0-4 Blanco

Pcs	m2	Kg
10 x Cj	1,014 x Cj	8 x Cj
600 x Pal	60,84 x Pal	480 x Pal



Wall Coverings Trend Stripes Whites

Worn

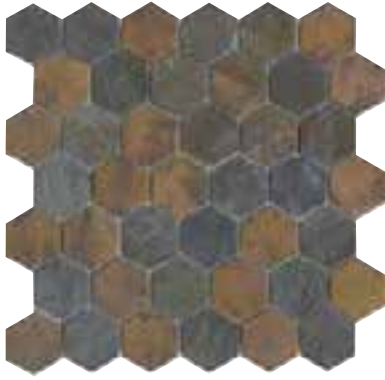

Worn Hexagon Copper

30x30,5x0,8cm - 11 3/4"x12"x3/8"
100213739 - L241715361 - G-136



MATT



MESHED



INDOOR
WALL
COVERING

QUARTZITE / CUARCITA / QUARTZITES
METAL / METAL / MÉTAL

Butech: Colorstuk 0-4 Antracita

Pcs	m2	Kg
11 x Cj	1,01 x Cj	14,34 x Cj
528 x Pal	48,31 x Pal	688,51 x Pal

NEW



Worn Hexagon Verdigris

30x30,5x0,8cm - 11 3/4"x12"x3/8"
100213698 - L241715271 - G-135



MATT



MESHED



INDOOR
WALL
COVERING

QUARTZITE / CUARCITA / QUARTZITES
METAL / METAL / MÉTAL

Butech: Colorstuk 0-4 Gris

Pcs	m2	Kg
11 x Cj	1,01 x Cj	14,34 x Cj
528 x Pal	48,31 x Pal	688,51 x Pal

NEW



Wall Coverings Worn Hexagon Verdigris



Elements Mini Pattern Wind

29,8x29,8x0,9cm - 11 3/4"x11 3/4"x3/8"
100135755 - L241709591 - G-123



TRAVERTINE / TRAVERTINO / TRAVERTIN
GLASS / VIDRIO / VERRE

Butech: Colorstuk Rapid Gris

Pcs	m2	Kg
11 x Cj	0,97 x Cj	18,94 x Cj
594 x Pal	52,75 x Pal	1022,87 x Pal



Elements Mini Pattern Water

29,8x29,8x0,9cm - 11 3/4"x11 3/4"x3/8"
100135754 - L241709601 - G-130



MARBLE / MÁRMOL / MARBRÉ
GLASS / VIDRIO / VERRE

Butech: Colorstuk Rapid Blanco

Pcs	m2	Kg
11 x Cj	0,97 x Cj	18,94 x Cj
594 x Pal	52,75 x Pal	1022,87 x Pal



Elements Pattern Mineral

30,5x30,5x0,8cm - 12"x12"x3/8"
100161273 - L241712801 - G-143



GRANITE / GRANITO / GRANITE
GLASS / VIDRIO / VERRE

Butech: Colorstuk Rapid Cemento

Pcs	m2	Kg
11 x Cj	1,02 x Cj	19,34 x Cj
594 x Pal	55,25 x Pal	1044,85 x Pal



Elements Pattern Wind

29,7x29,7x0,9cm - 11 3/4"x11 3/4"x3/8"
100135759 - L241709531 - G-130



TRAVERTINE / TRAVERTINO / TRAVERTIN
GLASS / VIDRIO / VERRE
RESIN / RESINA / RÉSINE

Butech: Colorstuk Rapid Gris

Pcs	m2	Kg
11 x Cj	0,97 x Cj	18,80 x Cj
594 x Pal	52,39 x Pal	1015,14 x Pal



Elements Pattern Water

29,7x29,7x0,9cm - 11 3/4"x11 3/4"x3/8"
100135758 - L241709491 - G-130



MARBLE / MÁRMOL / MARBRÉ
GLASS / VIDRIO / VERRE
RESIN / RESINA / RÉSINE

Butech: Colorstuk Rapid Blanco

Pcs	m2	Kg
11 x Cj	0,97 x Cj	18,80 x Cj
594 x Pal	52,39 x Pal	1015,14 x Pal



Elements Pattern Earth

29,7x29,7x0,9cm - 11 3/4"x11 3/4"x3/8"
100135757 - L241709461 - G-130



MARBLE / MÁRMOL / MARBRÉ
GLASS / VIDRIO / VERRE
RESIN / RESINA / RÉSINE

Butech: Colorstuk Rapid Beige

Pcs	m2	Kg
11 x Cj	0,97 x Cj	18,80 x Cj
594 x Pal	52,39 x Pal	1015,14 x Pal

Art

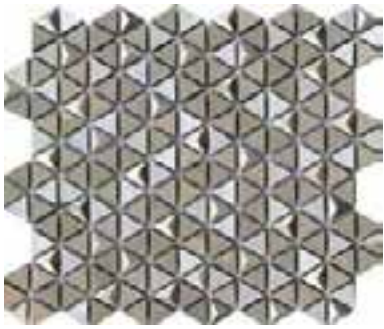

Art Roma

27x31x0,8cm - 10 5/8"x12 1/4"x3/8"
100190427 - L241714561 - G-140



LAVA STONE / PIEDRA VOLCÁNICA / PIERRE VOLCANIQUE
ALUMINIUM / ALUMINIO / ALUMINIUM

Butech: Colorstuk 0-4 Beige

Pcs	m2	Kg
11 x Cj	0,92 x Cj	13,09 x Cj
594 x Pal	49,71 x Pal	706,86 x Pal

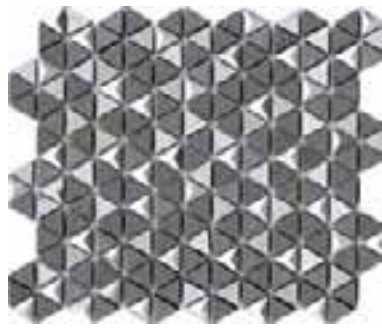

Art Berlin

27x31x0,8cm - 10 5/8"x12 1/4"x3/8"
100190430 - L241714631 - G-140



LAVA STONE / PIEDRA VOLCÁNICA / PIERRE VOLCANIQUE
ALUMINIUM / ALUMINIO / ALUMINIUM

Butech: Colorstuk 0-4 Gris

Pcs	m2	Kg
11 x Cj	0,92 x Cj	13,09 x Cj
594 x Pal	49,71 x Pal	706,86 x Pal



Art New York

27x31x0,8cm - 10 5/8"x12 1/4"x3/8"
100190436 - L241714611 - G-140



LAVA STONE / PIEDRA VOLCÁNICA / PIERRE VOLCANIQUE
ALUMINIUM / ALUMINIO / ALUMINIUM

Butech: Colorstuk 0-4 Antracita

Pcs	m2	Kg
11 x Cj	0,92 x Cj	13,09 x Cj
594 x Pal	49,71 x Pal	706,86 x Pal



Wall Coverings Art New York



Smooth and solid, clean and dry surface.

Superficie lisa y consistente, además de seca y limpia.

Surface lisse et consistante ; elle doit aussi être sèche et propre.

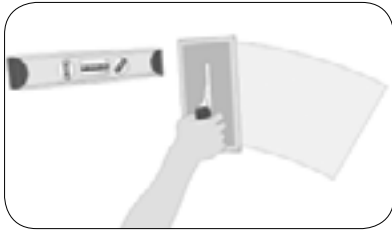

Level the surface in order to create a white background

Nivelar la superficie para crear un fondo blanco.

Niveler la surface pour créer un fond blanc.

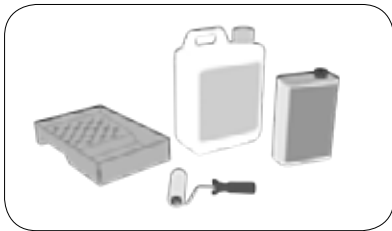

For levels greater than 2 mm, we recommend the use of specific products.

En nivelados superiores a 2mm se recomienda el uso de productos específicos.

Pour des nivelages supérieurs à 2mm, l'usage de produits spécifiques est recommandé.



Room temperature between 5°C and 30°C

Temperatura ambiente entre 5°C y 30°C.

Température ambiante entre 5°C et 30°C.

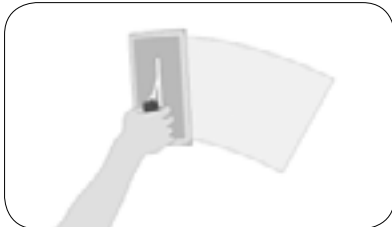

Extend the cement-based adhesive evenly on the wall with the flat side of a notched trowel. We recommend One-Flex by Butech.

Extender el adhesivo cementoso mediante el lado liso de una llana dentada uniformemente sobre el muro. Recomendamos One-Flex de Butech.

Étaler uniformément l'adhésif cimenteux sur le mur en utilisant le côté lisse d'une truelle à dents. Nous recommandons One-Flex de Butech.

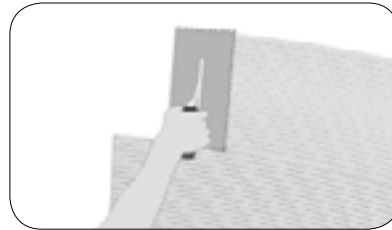

"Comb" the adhesive with the notched side (minimum notch 3 mm.) Do not spread the cement-based adhesive over large areas to prevent it from drying before placing the material.

"Peinar" el adhesivo con el lado dentado (mínimo 3mm). No extender el cemento cola en grandes superficies para evitar que se reseque antes de colocar el material.

«Brosser» l'adhésif avec la face dentelée (minimum 3mm). Ne pas étaler le ciment-colle sur de grandes surfaces, afin d'éviter qu'il sèche avant la pose du matériel.

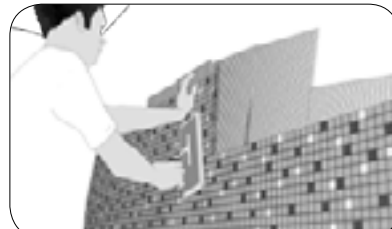

Lay the sheet and press it evenly with a rubber trowel.

Colocar la hoja y presionar uniformemente la misma con una llana de goma.

Placer la feuille et la presser uniformément avec une truelle en caoutchouc.

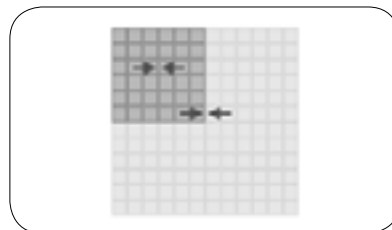

Ensure that the distance between the sheets is the same between pieces.

Asegurarse que la distancia entre hojas sea la misma que hay entre las piezas.

Vérifiez que la distance entre les feuilles et la même que celle entre les pièces.

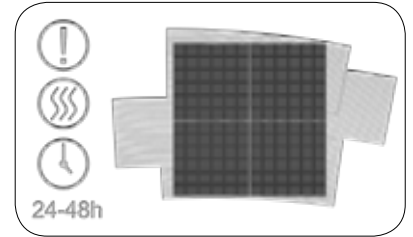

Let the adhesive dry for at least 24-48h. Before the adhesive dries, remove its remains with a sponge or cloth.

Dejar secar el adhesivo al menos 24-48h. Antes de que fragüe el adhesivo, retirar los restos con una esponja o un trapo.

Laisser l'adhésif sécher pendant au moins 24 à 48h. Avant la prise de l'adhésif, retirer les excédants à l'aide d'une éponge ou d'un chiffon.



GROUTING (applicable only for mosaics with joint)

REJUNTADO (aplicable sólo para mosaicos con junta)

REJOINTOIEMENT (applicable uniquement pour les mosaïques posées avec joint)

Perfectly clean pieces, and free from dust residue before grouting.

Piezas perfectamente limpias y sin restos de residuos de polvo antes de proceder al rejuntado.

Pièces parfaitement propres et sans poussière avant la phase de réalisation des joints.

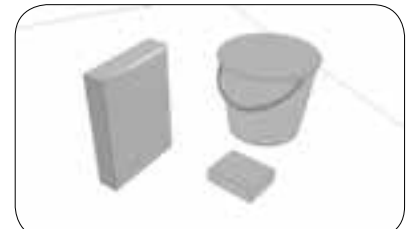

We recommend the use of Butech's Colorstuck Rapid. On the other hand, for polished surfaces, use Colorstuck Special n.

Se recomienda Colorstuck Rapid de Butech. En cambio, para superficies pulidas, usar Colorstuck Special n.

L'utilisation de Colorstuck Rapid de Butech est recommandée. Pour les surfaces polies, l'utilisation de Colorstuck Special n est recommandée.

Installation / Instalación / Installation

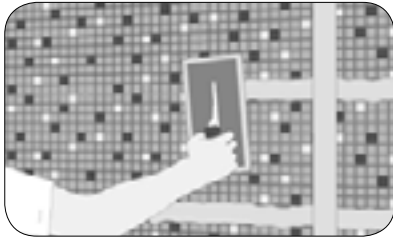

Spread the material with a rubber trowel, filling joints well.

Extender el material con una llana de goma rellenando bien las juntas.

Étaler le matériel avec une truelle en caoutchouc en remplissant bien les joints.



Use the same trowel to remove excess grout.

Utilizar la misma llana para eliminar el exceso.

Utiliser la même truelle pour éliminer le produit excédant.



Before the material dries, remove its remains with a sponge or cloth.

Antes de que fragüe el material, retirar los restos con una esponja o trapo.

Avant la prise du matériel, retirer les excédents à l'aide d'une éponge ou d'un chiffon.



For installations where the material is in contact with water (directly or indirectly), seal the grout adhesive with Fila Fob. We recommend the use of Butech's Epotech Aqua as grouting material.

Para instalaciones en las que el material esté en contacto con agua (directa o indirectamente) sellar el adhesivo de rejunte con Fila-Fob. Se recomienda el uso de Epotech Aqua de Butech como material de rejunte.

Pour des installations où le matériel est

en contact avec de l'eau (directement ou indirectement), sceller l'adhésif des joints avec Fila Fob. Nous recommandons l'utilisation d'Epotech Aqua de Butech pour faire les joints.

TO BE BORNE IN MIND IN THE CASE OF THE FUSION COLLECTION

ADEMÁS PARA LA COLECCIÓN FUSION HAY QUE TENER CUENTA

POUR LA COLLECTION, IL FAUT ÉGALEMENT PRENDRE EN COMPTE



Take special care with the use of hard or sharp objects such as installation tools, as some of these pieces may scratch easily due to their metallic nature.

Especial cuidado con el uso de objetos duros o agudos como herramientas de instalación, ya que algunas de sus piezas por su naturaleza metálica podrán rayarse con facilidad.

Il faut faire très attention lors de l'utilisation d'objets durs ou aigus, comme les outils d'installation, car certaines pièces métalliques peuvent se rayer facilement.

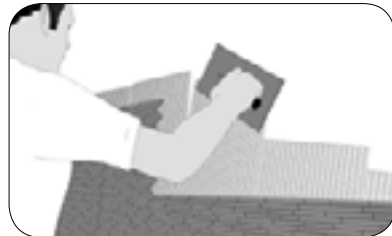

Maintain verticality so that all the aluminum tiles coincide at the grooves, and apply the adhesive in the opposite direction to the mosaic for a better grip.

Mantener la verticalidad para que todas las teselas de aluminio coincidan en los surcos y aplicar el adhesivo en el sentido contrario al mosaico para un mejor agarre.

Conserver la verticalité pour que tous les carrelés en aluminium coïncident dans les creux et appliquer l'adhésif dans le sens contraire de la mosaïque pour une meilleure prise.



NOTE: In Fusion 3D mosaics, even though they have a compact composition, there may be adhesive coming out between the tiles if there is more of it than necessary.

NOTA: Los mosaicos Fusión 3D, aun teniendo una composición compacta, puede ser que salga material de agarre entre las teselas si este está en mayor cantidad de la necesaria.

NOTE : Malgré la composition compacte des mosaïques Fusión 3D, le matériel de prise peut sortir entre les carrelés s'il y des quantités excédantes.



Grouting material with a non-neutral PH might react with the metal. Test before applying it on the entire surface, verifying that it does not change its natural color.

El material de rejunte con un PH no neutro puede reaccionar con el metal. Realizar una prueba antes de aplicarlo verificando que no cambia su color natural.

Le matériel pour faire les joints ayant un pH non neutre peut réagir avec le métal. Effectuer un test avant de l'appliquer pour vérifier que la couleur naturelle n'est pas altérée.

You can see these installation instructions, as well as maintenance instructions, updated and with more detail, by visiting our website www.anticcolonial.com

Puedes revisar estas instrucciones de instalación, así como las de mantenimiento, actualizadas y con más detalle visitando nuestra página web www.anticcolonial.com

Pour réviser ces instructions d'installation, ainsi que celles d'entretien, mises à jour et plus détaillées, veuillez visiter notre site Internet www.anticcolonial.com

Air Mosaics

Floor Coverings Capuccino Grey Classico, Air Hexagon Black / **Wall Coverings** Capuccino Grey Classico, Air Hexagon Black/
Complementary Products Vintage L Habana Dark-Negro, Vintage Espejo L Negro





Air Black

1x1cm - 3/8"x3/8"

30x30x1cm - 11 3/4"x11 3/4"x3/8"
100156912- L241711981 - G-116



CERAMICS / CERÁMICA / CÉRAMIQUE

Butech: Colorstuk Rapid Negro

Pcs	m2	Kg
11 x Cj	0,99 x Cj	12,01 x Cj
594 x Pal	53,46 x Pal	648,64 x Pal

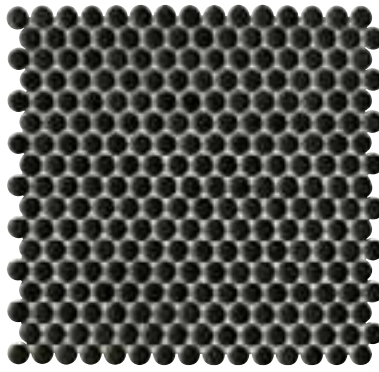

Air Dots Black Matt

31x32,4x0,6cm - 12 1/4"x12 3/4"x1/4"
100169350 - L241713411 - G-108



CERAMICS / CERÁMICA / CÉRAMIQUE

Butech: Colorstuk Rapid Negro

Pcs	m2	Kg
10 x Cj	1,00 x Cj	9,83 x Cj
720 x Pal	72,32 x Pal	707,76 x Pal

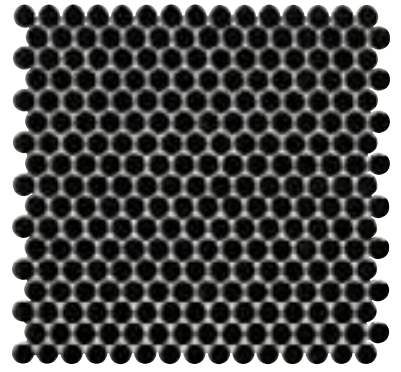

Air Dots Black

31x32,4x0,6cm - 12 1/4"x12 3/4"x1/4"
100169340 - L241713401 - G-108



CERAMICS / CERÁMICA / CÉRAMIQUE

Butech: Colorstuk Rapid Negro

Pcs	m2	Kg
10 x Cj	1,00 x Cj	9,83 x Cj
720 x Pal	72,32 x Pal	707,76 x Pal

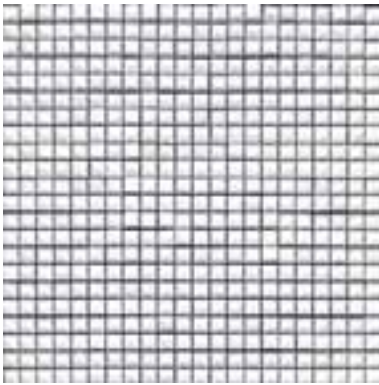

Air White

1x1cm - 3/8"x3/8"

30x30x1cm - 11 3/4"x11 3/4"x3/8"
100156914 - L241711991 - G-116



CERAMICS / CERÁMICA / CÉRAMIQUE

Butech: Colorstuk Rapid Blanco

Pcs	m2	Kg
11 x Cj	0,99 x Cj	12,01 x Cj
594 x Pal	53,46 x Pal	648,64 x Pal



Air Dots White Matt

31x32,4x0,6cm - 12 1/4"x12 3/4"x1/4"
100169342 - L241713431 - G-108



CERAMICS / CERÁMICA / CÉRAMIQUE

Butech: Colorstuk Rapid Blanco

Pcs	m2	Kg
10 x Cj	1,00 x Cj	9,83 x Cj
720 x Pal	72,32 x Pal	707,76 x Pal



Air Dots White

31x32,4x0,6cm - 12 1/4"x12 3/4"x1/4"
100169341 - L241713421 - G-108



CERAMICS / CERÁMICA / CÉRAMIQUE

Butech: Colorstuk Rapid Blanco

Pcs	m2	Kg
10 x Cj	1,00 x Cj	9,83 x Cj
720 x Pal	72,32 x Pal	707,76 x Pal

Air



Air Hexagon Black

27,2x30,4x0,6cm - 10 3/4"x12"x1/4"
100169343 - L241713441 - G-116



CERAMICS / CERÁMICA / CÉRAMIQUE

Butech: Colorstuk Rapid Negro

Pcs	m2	Kg
10 x Cj	1,00 x Cj	9,83 x Cj
720 x Pal	72,32 x Pal	707,76 x Pal



Air Hexagon Black Matt

27,2x30,4x0,6cm - 10 3/4"x12"x1/4"
100169344 - L241713451 - G-108



CERAMICS / CERÁMICA / CÉRAMIQUE

Butech: Colorstuk Rapid Negro

Pcs	m2	Kg
10 x Cj	1,00 x Cj	9,83 x Cj
720 x Pal	72,32 x Pal	707,76 x Pal



Air Hexagon White Matt

27,2x30,4x0,6cm - 10 3/4"x12"x1/4"
100169351 - L241713471 - G-108



CERAMICS / CERÁMICA / CÉRAMIQUE

Butech: Colorstuk Rapid Blanco

Pcs	m2	Kg
10 x Cj	1,00 x Cj	9,83 x Cj
720 x Pal	72,32 x Pal	707,76 x Pal



Air Hexagon White

27,2x30,4x0,6cm - 10 3/4"x12"x1/4"
100169360 - L241713461 - G-116

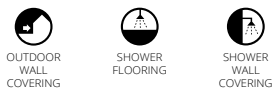

CERAMICS / CERÁMICA / CÉRAMIQUE

Butech: Colorstuk Rapid Blanco

Pcs	m2	Kg
10 x Cj	1,00 x Cj	9,83 x Cj
720 x Pal	72,32 x Pal	707,76 x Pal



Wall Coverings Air Dots White

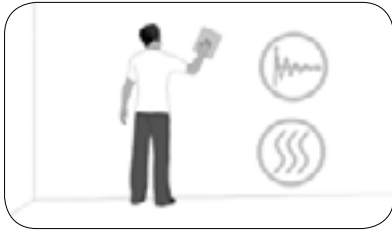

Smooth and solid, clean and dry surface.

Superficie lisa y consistente, además de seca y limpia.

Surface lisse et consistante ; elle doit aussi être sèche et propre.

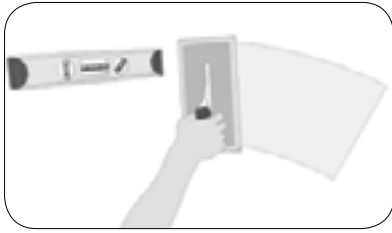

Level the surface in order to create a white background.

Nivelar la superficie para crear un fondo blanco.

Niveler la surface pour créer un fond blanc.

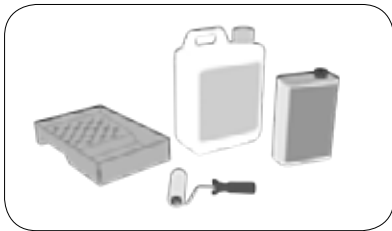

For levels greater than 2mm, we recommend the use of specific products.

En nivelados superiores a 2mm se recomienda el uso de productos específicos.

Pour des nivelages supérieurs à 2mm, l'usage de produits spécifiques est recommandé.



Room temperature between 5°C and 30°C

Temperatura ambiente entre 5°C y 30°C.

Température ambiante entre 5°C et 30°C.



Extend the cement-based adhesive evenly on the wall with the flat side of a notched trowel. We recommend One-flex by Butech.

Extender el adhesivo cementoso mediante el lado liso de una llana dentada uniformemente sobre el muro. Recomendamos One-flex de Butech.

Étaler uniformément l'adhésif cimenteux sur le mur en utilisant le côté lisse d'une truelle à dents. Nous recommandons One-Flex de Butech.

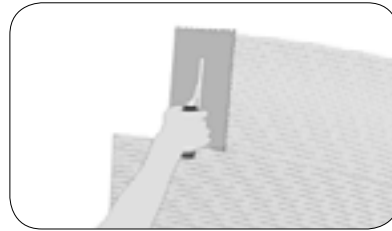

"Comb" the adhesive with the notched side (minimum notch 3mm.) Do not spread the cement-based adhesive over large areas to prevent it from drying before placing the material.

"Peinar" el adhesivo con el lado dentado (mínimo 3mm). No extender el cemento cola en grandes superficies para evitar que se reseque antes de colocar el material.

«Brosser» l'adhésif avec la face dentelée (minimum 3mm). Ne pas étaler le ciment-colle sur de grandes surfaces, afin d'éviter qu'il sèche avant la pose du matériel.

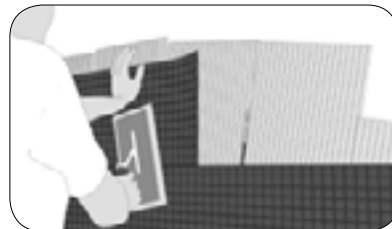

Lay the sheet and press evenly with a rubber trowel.

Colocar la hoja y presionar uniformemente con una llana de goma.

Placer la feuille et presser uniformément avec une truelle en caoutchouc.

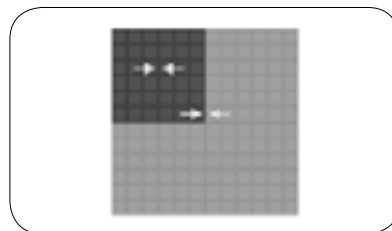

Ensure that the distance between the sheets is the same between pieces.

Asegurarse que la distancia entre hojas sea la misma que hay entre las piezas.

Vérifiez que la distance entre les feuilles et la même que celle entre les pièces.

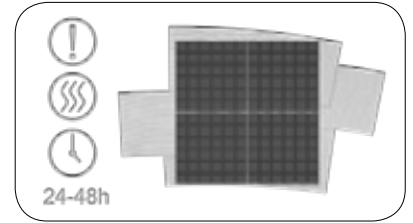

Let the adhesive dry for at least 24-48h. Before the adhesive dries, remove its remains with a sponge or cloth.

Dejar secar el adhesivo al menos 24-48h. Antes de que fragüe el adhesivo, retirar los restos con una esponja o un trapo.

Laisser l'adhésif sécher pendant au moins 24 à 48h. Avant la prise de l'adhésif, retirer les excédents à l'aide d'une éponge ou d'un chiffon.

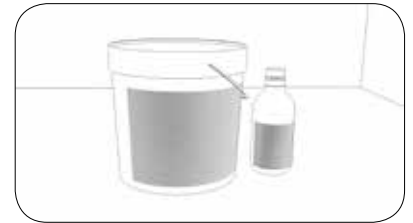

GROUTING

REJUNTADO

REJOINTOIEMENT

Perfectly clean pieces, and free from dust residue before grouting.

Piezas perfectamente limpias y sin restos de residuos de polvo antes de proceder al rejuntado.

Pièces parfaitement propres et sans poussière avant la phase de réalisation des joints.

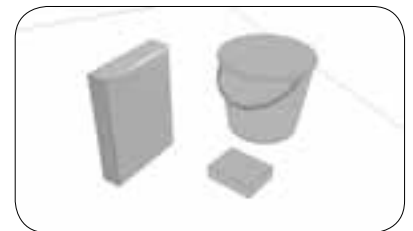

We recommend the use of Butech's Colorstuck Rapid. On the other hand, for polished surfaces, use Colorstuck Special n.

Se recomienda Colorstuck Rapid de Butech. En cambio, para superficies pulidas, usar Colorstuck Special n.

L'utilisation de Colorstuck Rapid de Butech est recommandée. Pour les surfaces polies, l'utilisation de Colorstuck Special n est recommandée.

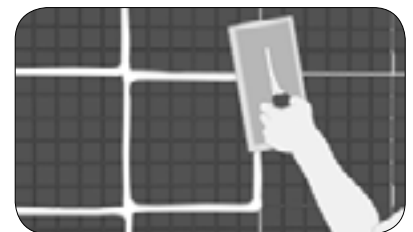

Installation / Instalación / Installation

Spread the material with a rubber trowel, filling joints well.

Extender el material con una llana de goma rellenando bien las juntas.

Étaler le matériel avec une truelle en caoutchouc en remplissant bien les joints.

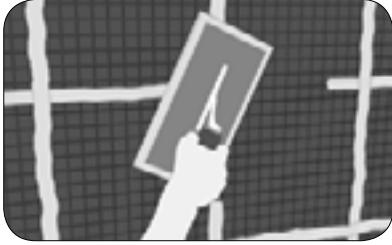

Use the same trowel to remove excess grout.

We do not recommend using highly-opposite colors, as it might make cleaning the joint more difficult.

Utilizar la misma llana para eliminar el exceso.

No se recomiendan colores altamente opuestos, ya que puede dificultar la limpieza de la junta.

Utiliser la même truelle pour éliminer le produit excédant.

L'utilisation de couleurs très opposées n'est pas recommandée ; le nettoyage des joints peut être plus difficile.

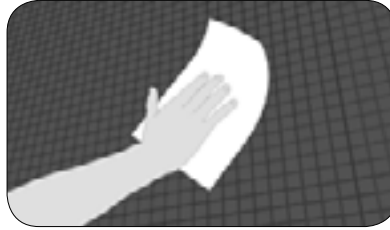

Before the material dries, remove its remains with a sponge or cloth.

Antes de que fragüe el material, retirar los restos con una esponja o trapo.

Avant la prise du matériel, retirer les excédents à l'aide d'une éponge ou d'un chiffon.

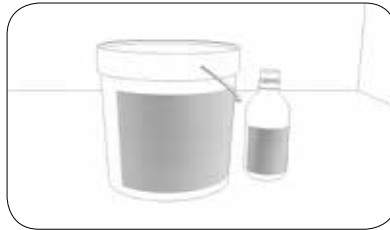

For installations where the material will be in contact with water (directly or indirectly,) we recommend Butech's Epotech Aqua as grouting material.

Para instalaciones en las que el material esté en contacto con agua (directa o indirectamente) se recomienda como material de rejunte

de Epotech Aqua de Butech.

Pour des installations où le matériel est en contact avec de l'eau (directement ou indirectement), l'utilisation d'Epotech Aqua de Butech pour faire les joints est recommandée.

You can see these installation instructions, as well as maintenance instructions, updated and with more detail, by visiting our website www.anticcolonial.com

Puedes revisar estas instrucciones de instalación, así como las de mantenimiento, actualizadas y con más detalle visitando nuestra página web www.anticcolonial.com

Pour réviser ces instructions d'installation, ainsi que celles d'entretien, mises à jour et plus détaillées, veuillez visiter notre site Internet www.anticcolonial.com



Wall Coverings Air Black

Metal Mosaics

—
Metal
Gravity
Colors
Worn

Floor Coverings Blanco Almeria Anticato / Wall Coverings Gravity Aluminium Cubic Gold



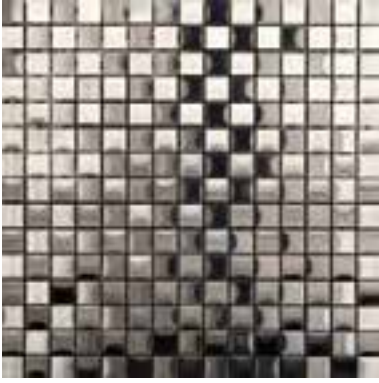

Metal Acero

1,85x1,85cm - 5/8"x5/8"

29,5x29,5x0,8cm - 11 5/8"x11 5/8"x3/8"
100095850 - L159800261 - G-139



GLOSS



MESHED



INDOOR
WALL
COVERING

METAL / METAL / MÉTAL

Butech: Colorstuk Especial Nacaré

Pcs	m2	Kg
10 x Cj	0,87 x Cj	16,64 x Cj
540 x Pal	46,99 x Pal	898,77 x Pal



Metal Acero Highlights

2x2cm - 3/4"x3/4"

30,5x30,5x0,8cm - 12"x12"x3/8"
100089009 - L153401521 - G-139



GLOSS



MESHED



INDOOR
WALL
COVERING

METAL / METAL / MÉTAL

Butech: Colorstuk Especial Nacaré

Pcs	m2	Kg
10 x Cj	0,93 x Cj	16,73 x Cj
540 x Pal	50,23 x Pal	903,60 x Pal



Metal Acero Highlights Golden

2x2cm - 3/4"x3/4"

30,5x30,5x0,8cm - 12"x12"x3/8"
100089008 - L153401531 - G-142



GLOSS



MESHED



INDOOR
WALL
COVERING

METAL / METAL / MÉTAL

Butech: Colorstuk Beech

Pcs	m2	Kg
10 x Cj	0,93 x Cj	16,73 x Cj
540 x Pal	50,23 x Pal	903,60 x Pal



Metal Brick Acero

2x4cm - 3/4"x1 5/8"

29,5x28x0,8cm - 11 5/8"x11"x3/8"
100095851 - L1598002711 - G-142



GLOSS



MESHED



INDOOR
WALL
COVERING

METAL / METAL / MÉTAL

Butech: Colorstuk Especial Nacaré

Pcs	m2	Kg
10 x Cj	0,83 x Cj	16,64 x Cj
540 x Pal	44,60 x Pal	898,77 x Pal



Metal Acero Hexagon

24,5x24,5x0,8cm - 9 5/8"x9 5/8"x3/8"
100146063 - L241710081 - G-139



IRREGULAR
TEXTURE



GLOSS



MESHED



INDOOR
WALL
COVERING

METAL / METAL / MÉTAL

No supported grouting / No admite rejuntado /
Ne peut pas être jointoyé.

Pcs	m2	Kg
8 x Cj	0,48 x Cj	8 x Cj
576 x Pal	34,70 x Pal	576 x Pal

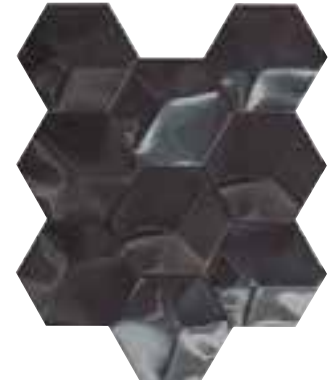

Metal Acero Hexagon Anthracite

24,5x24,5x0,8cm - 9 5/8"x9 5/8"x3/8"
100146064 - L241710111 - G-142



IRREGULAR
TEXTURE



GLOSS



MESHED



INDOOR
WALL
COVERING

METAL / METAL / MÉTAL

No supported grouting / No admite rejuntado /
Ne peut pas être jointoyé.

Pcs	m2	Kg
8 x Cj	0,48 x Cj	8 x Cj
576 x Pal	34,70 x Pal	576 x Pal

Metal

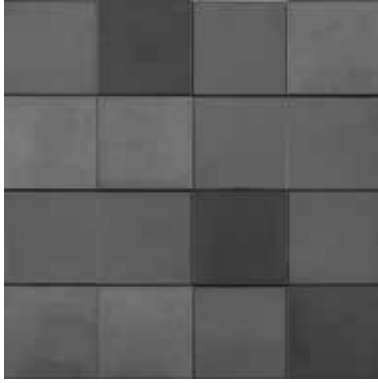

Metal Acero Anthracite 3D Cubes

30x30x0,7-1,1cm - 11 3/4"x11 3/4"x1/4"-3/8"
100171984 - L241713781 - G-139



METAL / METAL / MÉTAL

No supported grouting / No admite rejuntado /
Ne peut pas être jointoyé.

Pcs	m2	Kg
7 x Cj 378 x Pal	0,63 x Cj 34,02 x Pal	3,98 x Cj 215,08 x Pal

• STOCK



Metal Bronze 3D Cubes

30x30x0,7-1,1cm - 11 3/4"x11 3/4"x1/4"-3/8"
100171985 - L241713771 - G-143



METAL / METAL / MÉTAL

No supported grouting / No admite rejuntado /
Ne peut pas être jointoyé.

Pcs	m2	Kg
7 x Cj 378 x Pal	0,63 x Cj 34,02 x Pal	3,98 x Cj 215,08 x Pal

• STOCK

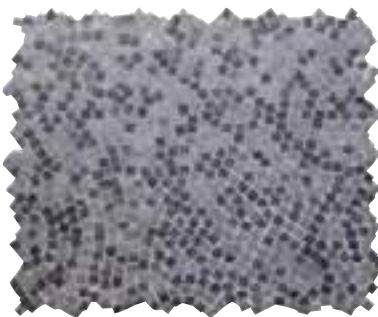

Metal Mini Cubes Dark

32,1x38,9x0,8cm - 12 5/8"x15 3/8"x3/8"
100190434 - L241714621 - G-150



METAL / METAL / MÉTAL

Butech: Colorstuk Ash

Pcs	m2	Kg
11 x Cj 594 x Pal	1,37 x Cj 74,17 x Pal	7,40 x Cj 399,76 x Pal

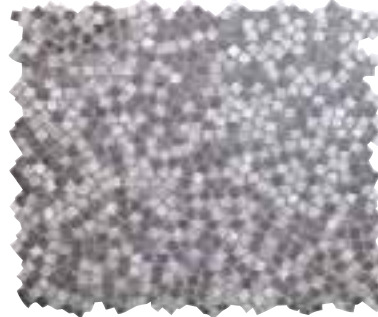

Metal Mini Cubes Light

32,1x38,9x0,8cm - 12 5/8"x15 3/8"x3/8"
100190435 - L241714601 - G-150



METAL / METAL / MÉTAL

Butech: Colorstuk Ash

Pcs	m2	Kg
11 x Cj 594 x Pal	1,37 x Cj 74,17 x Pal	7,40 x Cj 399,76 x Pal

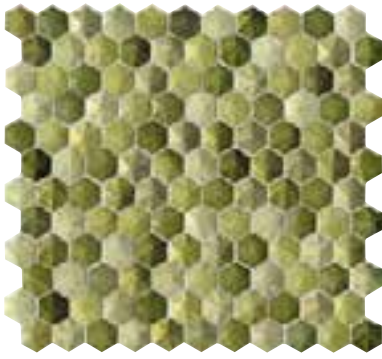

Colors Aluminium Olive

28,5x30,5x0,2cm - 11 1/4"x12"x1/16"
100203093 - L241714821 - G-143



ALUMINIUM / ALUMINIO / ALUMINIUM

Butech: Colorstuk 0-4 Gris

Pcs	m2	Kg
22 x Cj	1,91 x Cj	8,18 x Cj
1188 x Pal	103,26 x Pal	441,93 x Pal

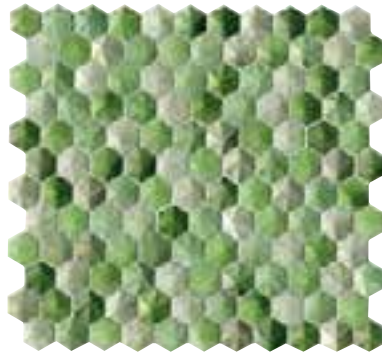

Colors Aluminium Forest

28,5x30,5x0,2cm - 11 1/4"x12"x1/16"
100203111 - L241714841 - G-143



ALUMINIUM / ALUMINIO / ALUMINIUM

Butech: Colorstuk 0-4 Gris

Pcs	m2	Kg
22 x Cj	1,91 x Cj	8,18 x Cj
1188 x Pal	103,26 x Pal	441,93 x Pal



Colors Aluminium Jean

28,5x30,5x0,2cm - 11 1/4"x12"x1/16"
100203120 - L241714861 - G-143



ALUMINIUM / ALUMINIO / ALUMINIUM

Butech: Colorstuk 0-4 Gris

Pcs	m2	Kg
22 x Cj	1,91 x Cj	8,18 x Cj
1188 x Pal	103,26 x Pal	441,93 x Pal

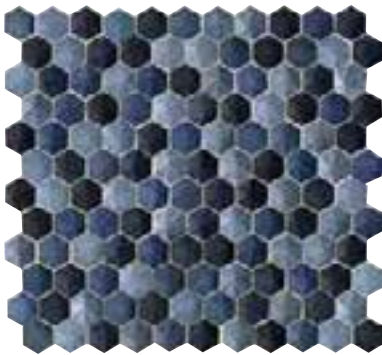

Colors Aluminium Space

28,5x30,5x0,2cm - 11 1/4"x12"x1/16"
100203121 - L241714851 - G-143



ALUMINIUM / ALUMINIO / ALUMINIUM

Butech: Colorstuk 0-4 Gris

Pcs	m2	Kg
22 x Cj	1,91 x Cj	8,18 x Cj
1188 x Pal	103,26 x Pal	441,93 x Pal

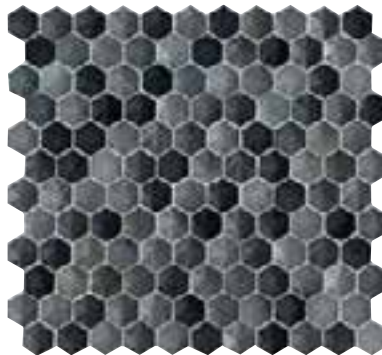

Colors Aluminium Pepper

28,5x30,5x0,2cm - 11 1/4"x12"x1/16"
100206464 - L241715031 - G-143



ALUMINIUM / ALUMINIO / ALUMINIUM

Butech: Colorstuk 0-4 Antracita

Pcs	m2	Kg
22 x Cj	1,91 x Cj	8,18 x Cj
1188 x Pal	103,26 x Pal	441,93 x Pal



Colors Aluminium Chocolate

28,5x30,5x0,2cm - 11 1/4"x12"x1/16"
100206470 - L241715011 - G-143



ALUMINIUM / ALUMINIO / ALUMINIUM

Butech: Colorstuk 0-4 Moka

Pcs	m2	Kg
22 x Cj	1,91 x Cj	8,18 x Cj
1188 x Pal	103,26 x Pal	441,93 x Pal



Colors



Colors Aluminium Crimson

28,5x30,5x0,2cm - 11 1/4"x12"x1/16"
100206471- L241715021 - G-143



ALUMINIUM / ALUMINIO / ALUMINIUM

Butech: Colorstuk 0-4 Gris

Pcs	m2	Kg
22 x Cj	1,91 x Cj	8,18 x Cj
1188 x Pal	103,26 x Pal	441,93 x Pal

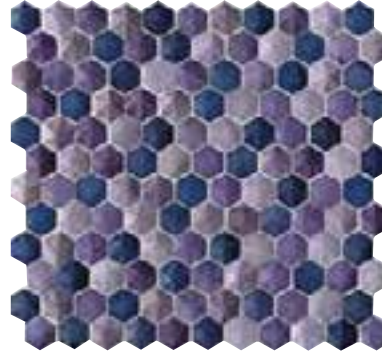

Colors Aluminium Nebolous

28,5x30,5x0,2cm - 11 1/4"x12"x1/16"
100206723- L241715041 - G-143



ALUMINIUM / ALUMINIO / ALUMINIUM

Butech: Colorstuk 0-4 Gris

Pcs	m2	Kg
22 x Cj	1,91 x Cj	8,18 x Cj
1188 x Pal	103,26 x Pal	441,93 x Pal



Wall Coverings Colors Aluminium Space

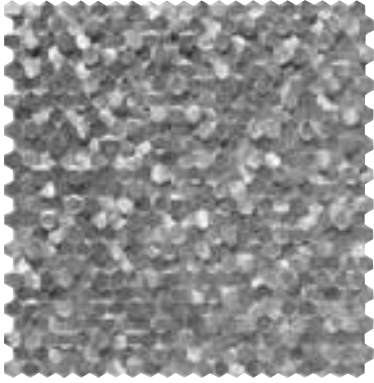

Gravity Aluminium 3D Hexagon Metal

30,4x31x0,3cm - 12"x12 1/4"x1/8"
100169742 - L241713651 - G-150



ALUMINIUM / ALUMINIO / ALUMINIUM

No supported grouting / No admite rejuntado /
Ne peut pas être jointoyé.

Pcs	m2	Kg
22 x Cj	2,07 x Cj	15,09 x Cj
792 x Pal	74,64 x Pal	543,31 x Pal

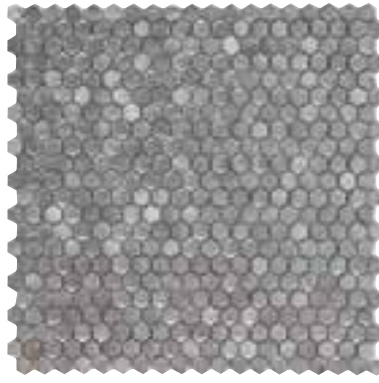

Gravity Aluminium Hexagon Metal

31x31x0,3cm - 12 1/4"x12 1/4"x1/8"
100160545 - L241712641 - G-150



ALUMINIUM / ALUMINIO / ALUMINIUM

Butech: Colorstuk Especial Nacaré

Pcs	m2	Kg
22 x Cj	2,11 x Cj	12,98 x Cj
1188 x Pal	114,16 x Pal	700,92 x Pal



Gravity Aluminium Cubic Metal
0,8x0,8cm - 3/8"x3/8"

31x31x0,3cm - 12 1/4"x12 1/4"x1/8"
100160542 - L241712631 - G-150



ALUMINIUM / ALUMINIO / ALUMINIUM

Butech: Colorstuk Especial Nacaré

Pcs	m2	Kg
22 x Cj	2,11 x Cj	12,98 x Cj
1188 x Pal	114,16 x Pal	700,92 x Pal



Gravity Aluminium Arrow Metal

29,8x30x0,4cm - 11 3/4"x11 3/4"x1/8"
100200501 - L241714901 - G-150



ALUMINIUM / ALUMINIO / ALUMINIUM

Butech: Colorstuk Especial Nacaré

Pcs	m2	Kg
22 x Cj	1,96 x Cj	14,25 x Cj
1188 x Pal	106,20 x Pal	769,82 x Pal



Gravity Aluminium Trace Metal

25x32,9x0,2cm - 9 7/8"x13"x1/16"
100214057 - L241715241 - G-146



ALUMINIUM / ALUMINIO / ALUMINIUM

Butech: Colorstuk Especial Nacaré

Pcs	m2	Kg
22 x Cj	1,81 x Cj	12,21 x Cj
1188 x Pal	97,71 x Pal	659,34 x Pal



Gravity



Gravity Aluminium 3D Hexagon Gold

30,4x31x0,3cm - 12"x12 1/4"x1/8"
100169728 - L241713641 - G-150



ALUMINIUM / ALUMINIO / ALUMINIUM

No supported grouting / No admite rejuntado /
Ne peut pas être jointoyé.

Pcs	m2	Kg
22 x Cj	2,07 x Cj	15,09 x Cj
792 x Pal	74,64 x Pal	543,31 x Pal



Gravity Aluminium Hexagon Gold

31x31x0,3cm - 12 1/4"x12 1/4"x1/8"
100160544 - L241712651 - G-150



ALUMINIUM / ALUMINIO / ALUMINIUM

Butech: Colorstuk Especial Vanilla

Pcs	m2	Kg
22 x Cj	2,11 x Cj	12,98 x Cj
1188 x Pal	114,16 x Pal	700,92 x Pal

• STOCK



Gravity Aluminium Cubic Gold 0,8x0,8cm - 3/8"x3/8"

31x31x0,3cm - 12 1/4"x12 1/4"x1/8"
100160541 - L241712671 - G-150



ALUMINIUM / ALUMINIO / ALUMINIUM

Butech: Colorstuk Especial Vanilla

Pcs	m2	Kg
22 x Cj	2,11 x Cj	12,98 x Cj
1188 x Pal	114,16 x Pal	700,92 x Pal

• STOCK



Gravity Aluminium Arrow Gold

29,8x30x0,4cm - 11 3/4"x11 3/4"x1/8"
100200502 - L241714751 - G-150



ALUMINIUM / ALUMINIO / ALUMINIUM

Butech: Colorstuk Especial Vanilla

Pcs	m2	Kg
22 x Cj	1,96 x Cj	12,98 x Cj
1188 x Pal	106,20 x Pal	700,92 x Pal

• NEW



Gravity Aluminium Trace Gold

25x32,9x0,2cm - 9 7/8"x13"x1/16"
100214029 - L241715231 - G-146



ALUMINIUM / ALUMINIO / ALUMINIUM

Butech: Colorstuk Especial Vanilla

Pcs	m2	Kg
22 x Cj	1,81 x Cj	12,21 x Cj
1188 x Pal	97,71 x Pal	659,34 x Pal

• NEW



Gravity Aluminium 3D Hexagon Rose Gold

30,4x31x0,3cm - 12"x12 1/4"x1/8"
100187394 - L241714481 - G-150



ALUMINIUM / ALUMINIO / ALUMINIUM

No supported grouting / No admite rejuntado /
Ne peut pas être jointoyé.

Pcs	m2	Kg
22 x Cj	2,07 x Cj	15,09 x Cj
792 x Pal	74,64 x Pal	543,31 x Pal



Gravity Aluminium Hexagon Rose Gold

31x31x0,3cm - 12 1/4"x12 1/4"x1/8"
100187415 - L241714491 - G-150



ALUMINIUM / ALUMINIO / ALUMINIUM

Butech: Colorstuk Honey

Pcs	m2	Kg
22 x Cj	2,11 x Cj	12,98 x Cj
1188 x Pal	114,16 x Pal	700,92 x Pal



Gravity Aluminium Cubic Rose Gold 0,8x0,8cm - 3/8"x3/8"

31x31x0,3cm - 12 1/4"x12 1/4"x1/8"
100187409 - L241714501 - G-150



ALUMINIUM / ALUMINIO / ALUMINIUM

Butech: Colorstuk Honey

Pcs	m2	Kg
22 x Cj	2,11 x Cj	14,25 x Cj
1188 x Pal	114,16 x Pal	769,82 x Pal



Gravity Aluminium Arrow Rose Gold

29,8x30x0,4cm - 11 3/4"x11 3/4"x1/8"
100200499 - L241714891 - G-150



ALUMINIUM / ALUMINIO / ALUMINIUM

Butech: Colorstuk Honey

Pcs	m2	Kg
22 x Cj	1,96 x Cj	14,25x Cj
1188 x Pal	106,20 x Pal	769,82 x Pal

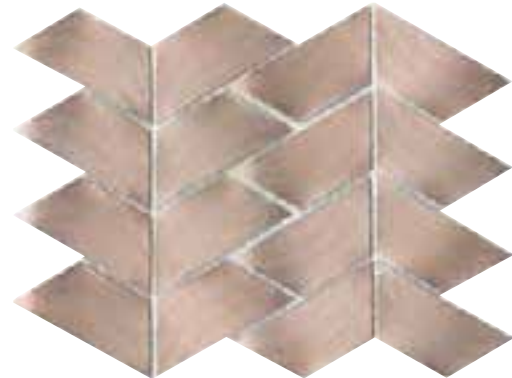

Gravity Aluminium Trace Rose Gold

25x32,9x0,2cm - 9 7/8"x13"x1/16"
100214048 - L241715251 - G-146



ALUMINIUM / ALUMINIO / ALUMINIUM

Butech: Colorstuk Honey

Pcs	m2	Kg
22 x Cj	1,81 x Cj	12,21 x Cj
1188 x Pal	97,71 x Pal	659,34 x Pal



Worn



Worn Copper

30x30x0,8cm - 11 3/4"x11 3/4"x3/8"
100213738 - L241715211 - G-139



MATT



MESHED



INDOOR
WALL
COVERING

METAL / METAL / MÉTAL

No supported grouting / No admite rejuntado /
Ne peut pas être jointoyé.

Pcs	m2	Kg	NEW
11 x Cj 528 x Pal	0,99 x Cj 47,52 x Pal	15,48 x Cj 743,42 x Pal	



Worn Verdigris

30x30x0,8cm - 11 3/4"x11 3/4"x3/8"
100213744 - L241715221 - G-139



MATT



MESHED



INDOOR
WALL
COVERING

METAL / METAL / MÉTAL

No supported grouting / No admite rejuntado /
Ne peut pas être jointoyé.

Pcs	m2	Kg	NEW
11 x Cj 528 x Pal	0,99 x Cj 47,52 x Pal	15,48 x Cj 743,42 x Pal	



Wall Coverings Gravity Aluminium Arrow Rose Gold

METAL MOSAICS



Smooth and solid, clean and dry surface.

Superficie lisa y consistente, además de seca y limpia.

Surface lisse et consistante; elle doit aussi être sèche et propre.

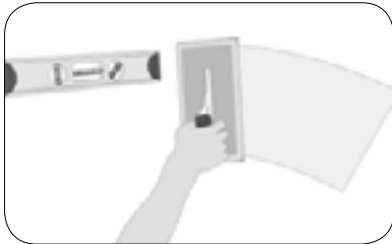

Level the surface in order to create a white background

Nivelar la superficie para crear un fondo blanco.

Niveler la surface pour créer un fond blanc.

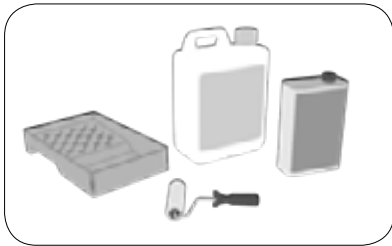

For levels greater than 2mm, we recommend the use of specific products.

En nivelados superiores a 2mm se recomienda el uso de productos específicos.

Pour des nivelages supérieurs à 2mm, l'usage de produits spécifiques est recommandé.



Room temperature between 5°C and 30°C. Take special care with the use of hard or sharp objects.

Temperatura ambiente entre 5°C y 30°C. Especial cuidado con el uso de objetos duros o agudos.

Température ambiante entre 5°C et 30°C. Faites très attention lors de l'utilisation d'objets durs ou aigus.

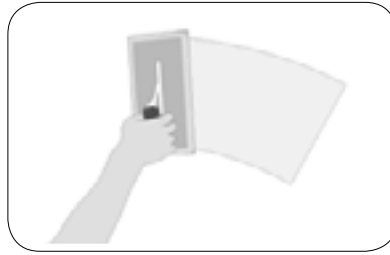

Extend the cement-based adhesive evenly on the wall with the flat side of a notched trowel. We recommend Butech's One-Flex for ceramic bases, and Butech's Politech for metal or plastic bases.

Extender el adhesivo cementoso mediante el lado liso de una llana dentada uniformemente sobre el muro. Recomendamos One-Flex de Butech para bases cerámicas y Politech de Butech para bases de metal o plástico.

Étaler uniformément l'adhésif cimenteux sur le mur en utilisant le côté lisse d'une truelle à dents. Nous recommandons l'utilisation de One-Flex de Butech pour les bases céramiques et de Politech de Butech pour les bases en métal ou en plastique.

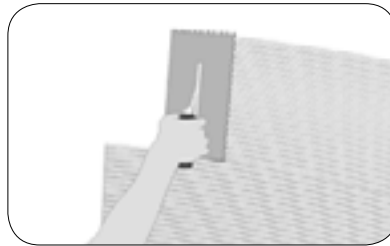

“Comb” the adhesive with the notched side (minimum notch 3mm). Do not spread the cement-based adhesive over large areas to prevent it from drying before placing the material.

“Peinar” el adhesivo con el lado dentado (mínimo 3mm). No extender el cemento cola en grandes superficies para evitar que se reseque antes de colocar el material.

«Brosser» l'adhésif avec la face dentelée (minimum 3mm). Ne pas étaler le ciment-colle sur de grandes surfaces, afin d'éviter qu'il sèche avant la pose du matériel.

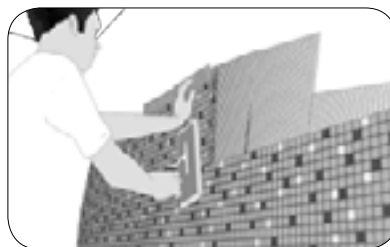

Lay the sheet and press evenly with a rubber trowel.

Colocar la hoja y presionar uniformemente con una llana de goma. Placer la feuille et presser uniformément avec une truelle en caoutchouc.

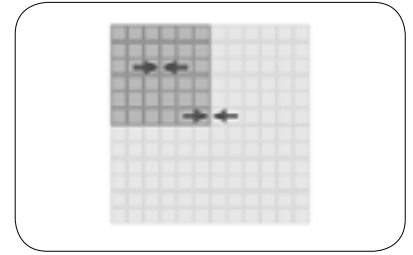

Ensure that the distance between the sheets is the same between pieces.

Asegurarse que la distancia entre hojas sea la misma que hay entre las piezas.

Vérifier que la distance entre les feuilles et la même que celle entre les pièces.

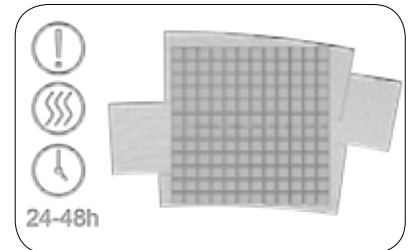

Let the adhesive dry for at least 24-48h. Before the adhesive dries, remove its remains with a sponge or cloth.

Dejar secar el adhesivo al menos 24-48h. Antes de que fragüe el adhesivo, retirar los restos con una esponja o un trapo.

Laisser l'adhésif sécher pendant au moins 24 à 48h. Avant la prise de l'adhésif, retirer les excédants à l'aide d'une éponge ou d'un chiffon.

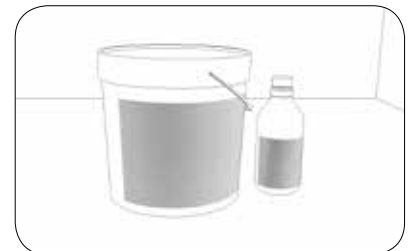

GROUTING (applicable only for mosaics with joint)

REJUNTADO (aplicable sólo para mosaicos con junta)

REJOINTOIEMENT (applicable uniquement pour les mosaïques posées avec joint)

Pieces that are perfectly clean and free from dust residue, before grouting.

Piezas perfectamente limpias y sin restos de residuos de polvo antes de proceder al rejuntado.

Pièces parfaitement propres et sans poussière avant la phase de réalisation des joints.

Installation / Instalación / Installation



We recommend Butech's Colorstuck Especial n.
Se recomienda Colorstuck Especial n de Butech.
L'utilisation de Colorstuck Especial n de Butech est recommandée.

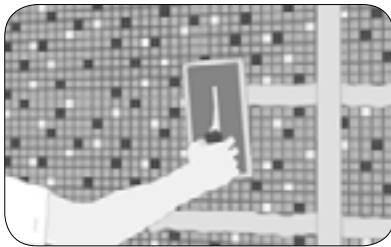

Spread the material with a rubber trowel, filling joints well.
Extender el material con una llana de goma rellenando bien las juntas.
Étaler le matériel avec une truelle en caoutchouc en remplissant bien les joints.



Use the same trowel to remove excess grout.
Utilizar la misma llana para eliminar el exceso.
Utiliser la même truelle pour éliminer le produit excédant.



Before the material dries, remove its remains with a sponge or cloth.
Antes de que fragüe el material, retirar los restos con una esponja o trapo.
Avant la prise du matériel, retirer les excédents à l'aide d'une éponge ou d'un chiffon.

CUTTING
CORTE
COUPE

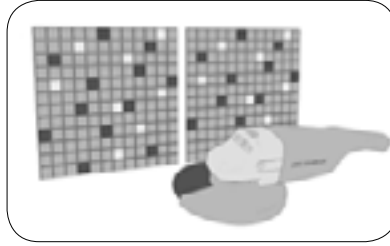

Use a circular saw with steel blade.
Utilizar una radial con disco de acero.
Utiliser une radiale avec un disque en acier.

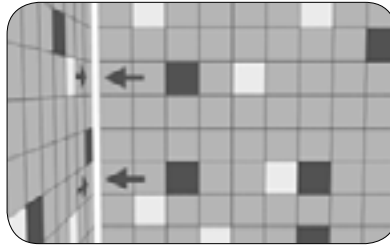

After cutting the mosaic, install the cut side concealed because there will always be dark residue on the pieces we have cut.

Tras cortar el mosaico, colocar la parte cortada oculta ya que siempre quedan restos oscuros sobre las piezas cortadas.

Après la découpe de la mosaïque, placer la partie cachée car il reste toujours des

parties foncées sur les pièces coupées.

You can see these installation instructions, as well as maintenance instructions, updated and with more detail, by visiting our website www.anticcolonial.com

Puedes revisar estas instrucciones de instalación, así como las de mantenimiento, actualizadas y con más detalle visitando nuestra página web www.anticcolonial.com

Pour réviser ces instructions d'installation, ainsi que celles d'entretien, mises à jour et plus détaillées, veuillez visiter notre site Internet www.anticcolonial.com



Wall Coverings Metal Bronze 3D Cubes

GRAVITY MOSAICS

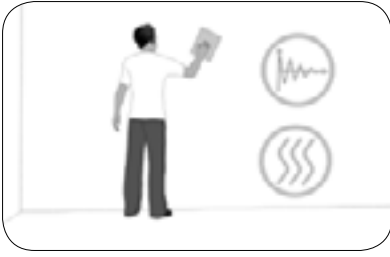

Smooth and solid, clean and dry surface.

Superficie lisa y consistente, además de seca y limpia.

Surface lisse et consistante ; elle doit aussi être sèche et propre.

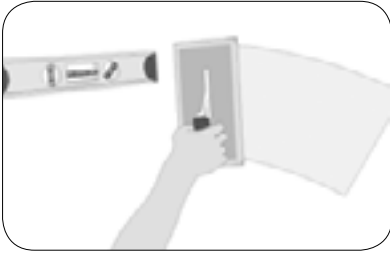

Level the surface in order to create a white background.

Nivelar la superficie para crear un fondo blanco.

Niveler la surface pour créer un fond blanc.

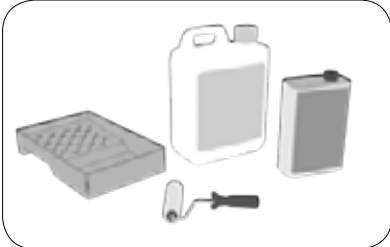

For levels greater than 2mm, we recommend the use of specific products.

En nivelados superiores a 2mm se recomienda el uso de productos específicos.

Pour des nivelages supérieurs à 2mm, l'usage de produits spécifiques est recommandé.



Room temperature between 5°C and 30°C Take special care with the use of hard or sharp objects.

Temperatura ambiente entre 5°C y 30°C. Especial cuidado con el uso de objetos duros o agudos.

Température ambiante entre 5°C et

30°C. Faites très attention lors de l'utilisation d'objets durs ou aigus.

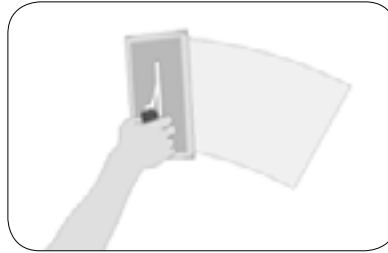

Extend the cement-based adhesive evenly on the wall with the flat side of a notched trowel. We recommend Butech's Politech N.

Extender el adhesivo mediante el lado liso de una llana dentada uniformemente sobre el muro. Se recomienda Politech N de Butech.

Étaler uniformément l'adhésif sur le mur en utilisant le côté lisse d'une truelle à dents. L'utilisation de Politech N de Butech est recommandée.

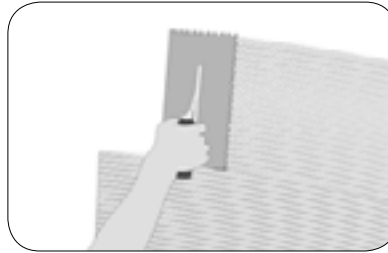

"Comb" the adhesive with the notched side (minimum notch 3mm.) Do not spread the cement-based adhesive over large areas to prevent it from drying before placing the material.

"Peinar" el adhesivo con el lado dentado (mínimo 3mm). No extender el cemento cola en grandes superficies para evitar que se reseque antes de colocar el material.

«Brosser» l'adhésif avec la face dentelée (minimum 3mm). Ne pas étaler le ciment-colle sur de grandes surfaces, afin d'éviter qu'il sèche avant la pose du matériel.

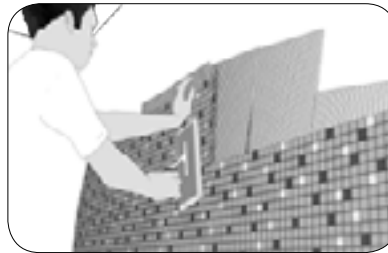

Lay the sheet and press evenly with a rubber trowel.

Colocar la hoja y presionar uniformemente con una llana de goma. Placer la feuille et presser uniformément avec une truelle en caoutchouc.

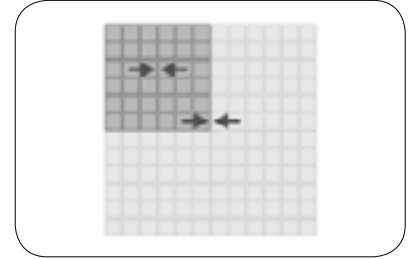

Ensure that the distance between the sheets is the same between pieces.

Asegurarse que la distancia entre hojas sea la misma que hay entre las piezas.

Vérifier que la distance entre les feuilles et la même que celle entre les pièces.

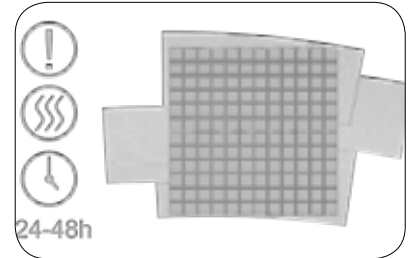

Let the adhesive dry for at least 24-48h. Before the adhesive dries, remove its remains with a sponge or cloth.

Dejar secar el adhesivo al menos 24-48h. Antes de que fragüe el adhesivo, retirar los restos con una esponja o un trapo.

Laisser l'adhésif sécher pendant au moins 24 à 48h. Avant la prise de l'adhésif, retirer les excédents à l'aide d'une éponge ou d'un chiffon.

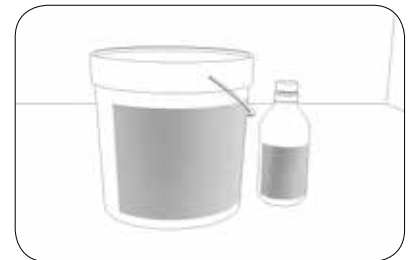

GROUTING (applicable only for mosaics with joint)

REJUNTADO (aplicable sólo para mosaicos con junta)

REJOINTOIEMENT (applicable uniquement pour les mosaïques posées avec joint)

Perfectly clean pieces, and free from dust residue before grouting.

Piezas perfectamente limpias y sin restos de residuos de polvo antes de proceder al rejuntado.

Pièces parfaitement propres et sans poussière avant la phase de réalisation des joints.

Installation / Instalación / Installation

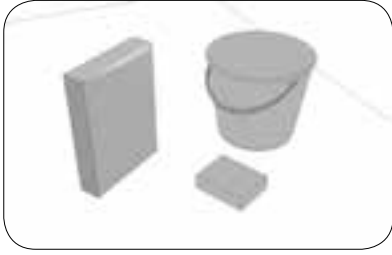

We recommend Butech's Colorstuck n.
Se recomienda Colorstuck n de Butech.
L'utilisation de Colorstuck N de Butech est recommandée.

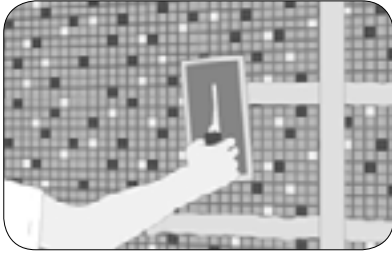

Spread the material with a rubber trowel, filling joints well.
Extender el material con una llana de goma rellenando bien las juntas.
Étaler le matériel avec une truelle en caoutchouc en remplissant bien les joints.



Use the same trowel to remove excess grout.
Utilizar la misma llana para eliminar el exceso.
Utiliser la même truelle pour éliminer le produit excédant.



Before the material dries, remove its remains with a sponge or cloth.
Antes de que fragüe el material, retirar los restos con una esponja o trapo.
Avant la prise du matériel, retirer les excédents à l'aide d'une éponge ou d'un chiffon.

CUTTING
CORTE
COUPE

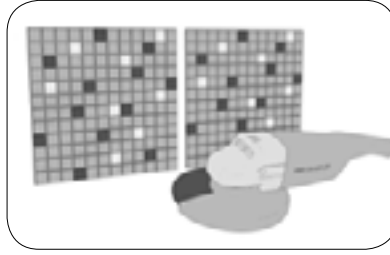

Use a circular saw with steel blade.
Utilizar una radial con disco de acero.
Utiliser une radiale avec un disque en acier.

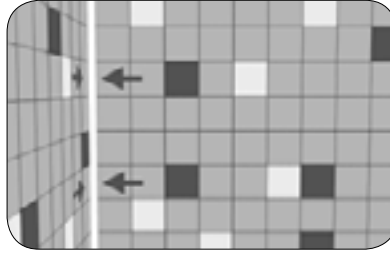

After cutting the mosaic, install the cut side concealed because there will always be dark residue on the pieces we have cut.
Tras cortar el mosaico, colocar la parte cortada oculta ya que siempre quedan restos oscuros sobre las piezas cortadas.
Après la découpe de la mosaïque, placer la partie cachée car il reste toujours des parties foncées sur les pièces coupées.

You can see these installation instructions, as well as maintenance instructions, updated and with more detail, by visiting our website www.anticcolonial.com

Puedes revisar estas instrucciones de instalación, así como las de mantenimiento, actualizadas y con más detalle visitando nuestra página web www.anticcolonial.com

Pour réviser ces instructions d'installation, ainsi que celles d'entretien, mises à jour et plus détaillées, veuillez visiter notre site Internet www.anticcolonial.com



Wall Coverings Gravity Aluminium Arrow Metal





Wood Mosaics

—



Wood Boxes

29,9x30,2x1,2cm - 11 3/4"x11 7/8"x1/2"
100169403 - L241713481 - G-139



OAK / ROBLE / CHÊNE

No supported grouting / No admite rejuntado /
Ne peut pas être jointoyé.

Pcs	m2	Kg
6 x Cj	0,54 x Cj	3,85 x Cj
300 x Pal	32,51 x Pal	231,12 x Pal



Wood Cubes

32x32x1,9cm - 12 5/8"x12 5/8"x3/4"
100169420 - L241713491 - G-156



OAK / ROBLE / CHÊNE

No supported grouting / No admite rejuntado /
Ne peut pas être jointoyé.

Pcs	m2	Kg
6 x Cj	0,61 x Cj	8,69 x Cj
252 x Pal	25,81 x Pal	365,15 x Pal



Wood Even

28x28x1cm - 11"x11"x3/8"
100062522 - L108004601 - G-153



CUMARÚ (TROPICAL WOOD) / CUMARÚ (MADERA TROPICAL) / CUMARÚ (DES BOIS TROPICAUX)

No supported grouting / No admite rejuntado /
Ne peut pas être jointoyé.

Pcs	m2	Kg
6 x Cj	0,47 x Cj	6,21 x Cj
216 x Pal	16,93 x Pal	223,56 x Pal



Wood Square Aged 3D

29,7x29,7x1,2cm - 11 3/4"x11 3/4"x1/2"
100161558 - L241712871 - G-140



RECYCLED WOOD / MADERA RECICLADA /
BOIS RECYCLÉ

No supported grouting / No admite rejuntado /
Ne peut pas être jointoyé.

Pcs	m2	Kg
6 x Cj	0,52 x Cj	7,45 x Cj
360 x Pal	31,75 x Pal	447,12 x Pal



Wood Square Aged

29,7x29,7x1,2-2,2cm - 11 3/4"x11 3/4"x1/2"-7/8"
100160512 - L241712711 - G-139



RECYCLED WOOD / MADERA RECICLADA /
BOIS RECYCLÉ

No supported grouting / No admite rejuntado /
Ne peut pas être jointoyé.

Pcs	m2	Kg
5 x Cj	0,44 x Cj	6,21 x Cj
240 x Pal	21,17 x Pal	298,08 x Pal



Wood Feel

30x30x1cm - 11 3/4"x11 3/4" x3/8"
100086257 - L108010211 - G-148



CUMARÚ (TROPICAL WOOD) / CUMARÚ (MADERA TROPICAL) / CUMARÚ (DES BOIS TROPICAUX)

No supported grouting / No admite rejuntado /
Ne peut pas être jointoyé.

Pcs	m2	Kg
5 x Cj	0,45 x Cj	7,89 x Cj
180 x Pal	16,20 x Pal	284 x Pal

Wood



Wood Modul

26x26,4x0,6-2,6cm - 10 1/4"x10 3/8"x1/4"-1"
100086262 - L154806021 - G-153



IRREGULAR
TEXTURE



MATT



MESHED



INDOOR
WALL
COVERING

CUMARÚ (TROPICAL WOOD) / CUMARÚ (MADERA TROPICAL) / CUMARÚ (DES BOIS TROPICAUX)

No supported grouting / No admite rejuntado /
Ne peut pas être jointoyé.

Pcs	m2	Kg
4 x Cj	0,28 x Cj	6,19 x Cj
144 x Pal	9,92 x Pal	222,91 x Pal

STOCK



Wood Brick

27,3x28x1cm - 10 3/4"x11"x3/8"
100097155 - L108015181 - G-148



IRREGULAR
TEXTURE



MATT



MESHED



INDOOR
WALL
COVERING

CUMARÚ (TROPICAL WOOD) / CUMARÚ (MADERA TROPICAL) / CUMARÚ (DES BOIS TROPICAUX)

No supported grouting / No admite rejuntado /
Ne peut pas être jointoyé.

Pcs	m2	Kg
6 x Cj	0,47 x Cj	5,36 x Cj
216 x Pal	16,93 x Pal	192,89 x Pal



Wood Square Antique

29,7x29,7x1cm - 11 3/4"x11 3/4"x3/8"
100146086 - L241710161 - G-134



IRREGULAR
TEXTURE



MATT



MESHED



INDOOR
WALL
COVERING

RECYCLED WOOD / MADERA RECICLADA /
BOIS RECYCLÉ

No supported grouting / No admite rejuntado /
Ne peut pas être jointoyé.

Pcs	m2	Kg
5 x Cj	0,44 x Cj	5,62 x Cj
240 x Pal	21,17 x Pal	269,76 x Pa



Wall Coverings Wood Cubes



Wood Wall Anthracite

60x24x0,5/3cm - 23 5/8"x9 1/2"x1/4"-1 1/8"
100179711 - L241714371 - G-159



OAK / ROBLE / CHÊNE

No supported grouting / No admite rejuntado /
Ne peut pas être jointoyé.

Pcs	m2	Kg
8 x Cj	1,15 x Cj	24,57 x Cj
160 x Pal	23,04 x Pal	491,52 x Pal



Wood Wall Bronze

60x24x0,5/3cm - 23 5/8"x9 1/2"x1/4"-1 1/8"
100179712 - L241714361 - G-159



OAK / ROBLE / CHÊNE

No supported grouting / No admite rejuntado /
Ne peut pas être jointoyé.

Pcs	m2	Kg
8 x Cj	1,15 x Cj	24,57 x Cj
160 x Pal	23,04 x Pal	491,52 x Pal



Wood Wall Chrome

60x24x0,5/3cm - 23 5/8"x9 1/2"x1/4"-1 1/8"
100179713 - L241714321 - G-159



OAK / ROBLE / CHÊNE

No supported grouting / No admite rejuntado /
Ne peut pas être jointoyé.

Pcs	m2	Kg
8 x Cj	1,15 x Cj	24,57 x Cj
160 x Pal	23,04 x Pal	491,52 x Pal



Wood Wall Pure

60x24x0,5/3cm - 23 5/8"x9 1/2"x1/4"-1 1/8"
100179730 - L241714341 - G-159



OAK / ROBLE / CHÊNE

No supported grouting / No admite rejuntado /
Ne peut pas être jointoyé.

Pcs	m2	Kg
8 x Cj	1,15 x Cj	24,57 x Cj
160 x Pal	23,04 x Pal	491,52 x Pal

Wood



Wood Wall Teak

61x15x0,9-2,4cm - 24"x5 7/8"x3/8"-1"
100190451 - L241714551 - G-131



IRREGULAR
TEXTURE



MATT



INDOOR
WALL
COVERING

TEAK / TEKA / TECK

No supported grouting / No admite rejuntado /
Ne peut pas être jointoyé.

Pcs	m2	Kg
11 x Cj	1,01 x Cj	10,02 x Cj
220 x Pal	20,31 x Pal	202,24 x Pal

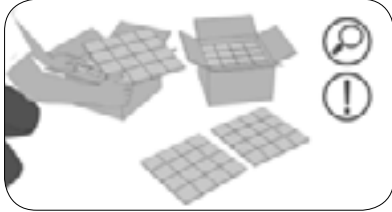

Wall Coverings Wood Wall Teak

WOOD MOSAICS**CONDITIONS FOR RECEPTIONS AND STORAGE****CONDICIONES DE RECEPCIÓN Y ALMACENAMIENTO****CONDITIONS DE RECEPTION ET STOCKAGE**

Check the mosaic batches taking into account the following aspects: type, color, and design; quantity supplied; dimensions and quality class or appearance; moisture content of the elements.

Verificar las partidas del mosaico, teniendo en cuenta: tipo, color y diseño; cantidad suministrada; dimensiones y clase de calidad o aspecto; contenido de humedad de los elementos.

Vérifier les parties de la mosaïque en prenant en considération la classe, la couleur et le dessin ; la quantité fournie ; les dimensions et le type de qualité ou d'aspect ; la teneur en humidité des éléments.



Store sheltered from the elements, in a ventilated, clean, and dry room.

Almacenar al abrigo de la intemperie, en local ventilado, limpio y seco.

Stocker à l'abri des intempéries, dans une pièce aérée, propre et sèche.

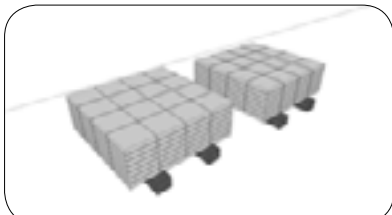

Stack leaving spaces between the wood, the floor, and the walls.

Apilar dejando espacios libres entre la madera, el suelo y las paredes.

Empiler en laissant des espaces vides entre le bois, le sol et les murs.

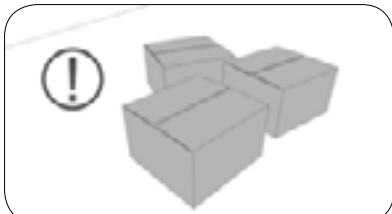

Keep in its package until use if it is wrapped in shrink plastic.

Mantener en sus paquetes hasta su uso en caso de que estén envueltos en plástico retráctil.

Les garder dans les paquets jusqu'à leur usage si elles sont enveloppées dans du plastique rétractile.

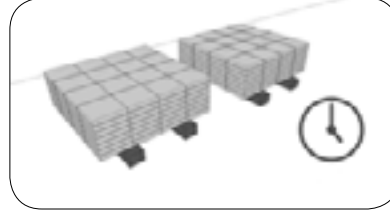

Keep the mosaic unpacked from cardboard and plastic for 72-120h at the place where it will be installed, in order to facilitate the adjustment of the wood to the site's temperature and humidity conditions.

Mantener el mosaico 72-120h desembalado de cartón y plástico en el lugar de instalación para facilitar la adaptación de la madera a las condiciones de temperatura y humedad del sitio.

Maintenir la mosaïque 72 à 120h débâllée du carton et du plastique au lieu où sera réalisée l'installation pour que le bois s'adapte aux conditions de température et d'humidité présentes.



Moisture content under 2.5% for wall and ceiling materials of the premises where the mosaic is to be installed, except for plasters and paints, which can have up to 5%.

Humedad inferior al 2,5% en los materiales de paredes y techos del recinto donde se instale el mosaico, salvo los yesos y pinturas que podrán alcanzar el 5%.

Humidité inférieure à 2,5% pour les matériaux des murs et des plafonds de la pièce où sera installée la mosaïque, sauf les plâtres et les peintures, qui peuvent atteindre 5% d'humidité.



Room hydrothermal conditions shall be between 30% and 65%.

Condiciones higrotérmicas del local entre el 30 y el 65%.

Conditions hygrothermiques de la pièce : entre 30 et 65%.



Do not carry out bonding or finishing works below 10°C or above 27°C.

No realizar trabajos de encolado o de acabado por debajo de 10°C, ni por encima de 27°C.

Ne pas effectuer des travaux de collage ou de finition à une température inférieure à 10°C ou supérieure à 27°C.

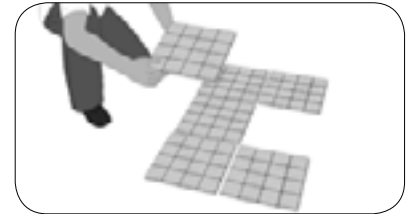
INSTALLATION**COLOCACIÓN****POSE**

Mix different hues of the mosaics on the floor before installing them on the wall to achieve a well-balanced finish.

Mezclar en el suelo las diferentes tonalidades de los mosaicos antes de colocarlos en la pared para conseguir un acabado armónico.

Mélanger sur le sol les différents tons des mosaïques avant de les placer sur le mur pour une finition harmonique.

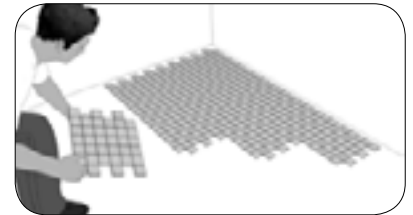

With the Brick, before installing them, extend the material on the floor and start fitting pieces together.

En los Brick, antes de instalarlos, extender el material en el suelo e ir encajando las piezas.

Avant l'installation des Bricks, étaler le matériel sur le sol et emboîter les pièces.

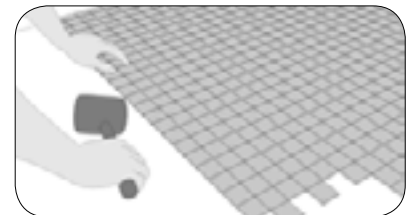

Use a rubber mallet to gently tap the material on the side of the piece, facilitating the fastening of the Bricks.

Usar una maceta de goma para golpear el material de forma suave

Installation / Instalación / Installation

en el lateral de la pieza, facilitando el anclaje de los Brick.

Utiliser un pot en caoutchouc pour marteler doucement la partie latérale de la pièce et faciliter ainsi l'ancrage des Bricks.



We recommend that the moisture of the mosaics be between 7% and 9%.
Se recomienda que la humedad de los mosaicos esté entre el 7 y el 9%.

Les mosaïques doivent avoir une humidité de 7 à 9%.



The substrate or base shall be compact throughout its thickness and surface, eliminating friable parts or those that become detached easily; it shall be completely dry, clean from dust, grease, or any other substance.

Soporte o fondo de colocación compacto en todo su espesor y superficie, eliminando las partes que puedan desprenderse, seco, limpio de polvo, grasas o de cualquier otra sustancia.

Le support ou fond de pose doit être compact sur toute la grosseur et la surface, sec, sans poussière, graisse ou toute autre substance. Éliminer les parties qui peuvent se détacher.

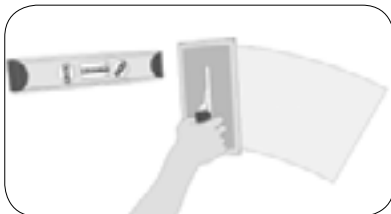

Check that the substrate is vertically aligned, properly leveled, and without defects in its flatness larger than 2mm.

Verificar que el soporte esté aplomado, nivelado y sin defectos en su planimetría superiores a 2mm.

Vérifier que le support est plombé, nivelé et sans défauts de planimétrie supérieurs à 2 mm.

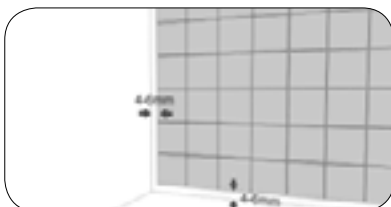

4 to 6mm perimeter joint. This joint can be filled in with flexible materials.

Junta perimetral de entre 4 y 6mm. Esta junta puede rellenarse con materiales flexibles.

Joint périphérique de 4 à 6mm. Ce joint peut être rempli avec des matériaux flexibles.

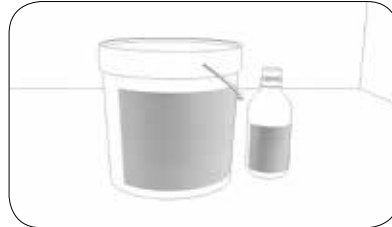

We recommend Butech's Politech.
Se recomienda Politech de Butech.

L'utilisation de Politech de Butech est recommandée.

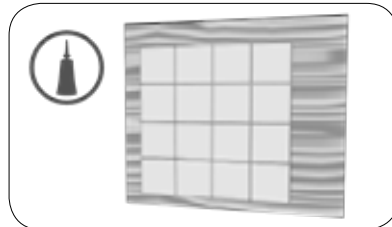

In order to install the mosaics on wood surfaces, we just need to apply the mosaics with white glue or wood glue.

Para instalar los mosaicos sobre madera es suficiente aplicar con cola blanca o para madera.

Pour la pose des mosaïques sur le bois, il suffit de les appliquer avec de la colle blanche ou pour bois.



Spread the adhesive by pressing it on the substrate with the smooth side of the trowel.

Extender el adhesivo presionando sobre el soporte por la parte lisa de la llana.

Étaler l'adhésif en pressant sur le support par la partie lisse de la truelle.

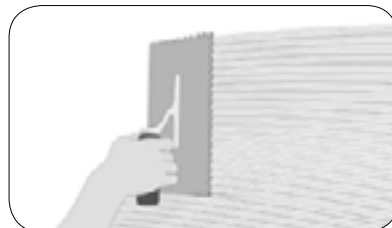

"Comb" it, using the notched side.

"Peinar" mediante la parte dentada.

Le «brosser» avec la partie dentée.

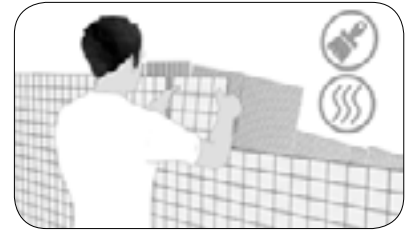

Check that the mosaic is clean, without residues or work remains, before the adhesive has formed a surface film.

Verificar que el mosaico esté limpio, sin residuos ni restos de obra, antes de que el adhesivo haya formado una película superficial.

Vérifier que la mosaïque est propre, sans déchets ni excédants des travaux avant que l'adhésif forme un film superficiel.

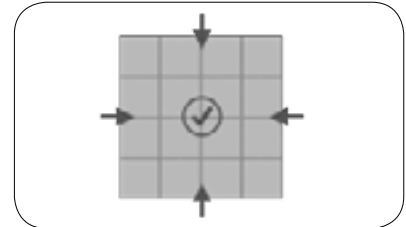

The hygroscopic characteristic of wood causes dimensional variations that are considered normal. The decrease in width of the pieces originates the appearance of joints between mosaic elements.

El carácter higroscópico de la madera produce variaciones dimensionales que se consideran como normales. La merma de las piezas en anchura produce la manifestación de las juntas entre los elementos del mosaico.

Le caractère hygroscopique du bois produit des variations des dimensions qui sont considérées normales. L'amointrissement des pièces en largeur provoque l'apparition des joints entre les éléments de la mosaïque.

You can see these installation instructions, as well as maintenance instructions, updated and with more detail, by visiting our website www.anticcolonial.com

Puedes revisar estas instrucciones de instalación, así como las de mantenimiento, actualizadas y con más detalle visitando nuestra página web www.anticcolonial.com

Pour réviser ces instructions d'installation, ainsi que celles d'entretien, mises à jour et plus détaillées, veuillez visiter notre site Internet www.anticcolonial.com

Customized
Mosaics
Mosaicos
Personalizados
Mosaiques
Personnalisées



PORCELANOSA

Mosaics

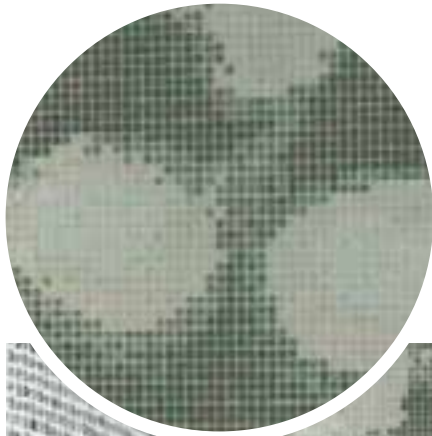

NORMAL PRECISION SYSTEM

Customized mosaics with an image made up of uncut square mosaic chips. A high-definition end result is not required. These mosaics are classified into 3 groups, depending on how hard it is to recreate the drawing with mosaic chips.

SISTEMA PRECISIÓN NORMAL

Mosaico personalizado en el que la imagen está formada por teselas cuadradas sin cortar y en el que no prima la definición de la misma. Se clasifican en tres grupos dependiendo de la dificultad en recrear el dibujo con las teselas.

SYSTÈME PRÉCISION NORMALE

Mosaïque personnalisée dans laquelle l'image est composée par des tesselles carrées non coupées et pour laquelle la définition de l'image n'est pas primordiale. Elle se classe en trois groupes en fonction de la difficulté de créer le dessin avec les tesselles.

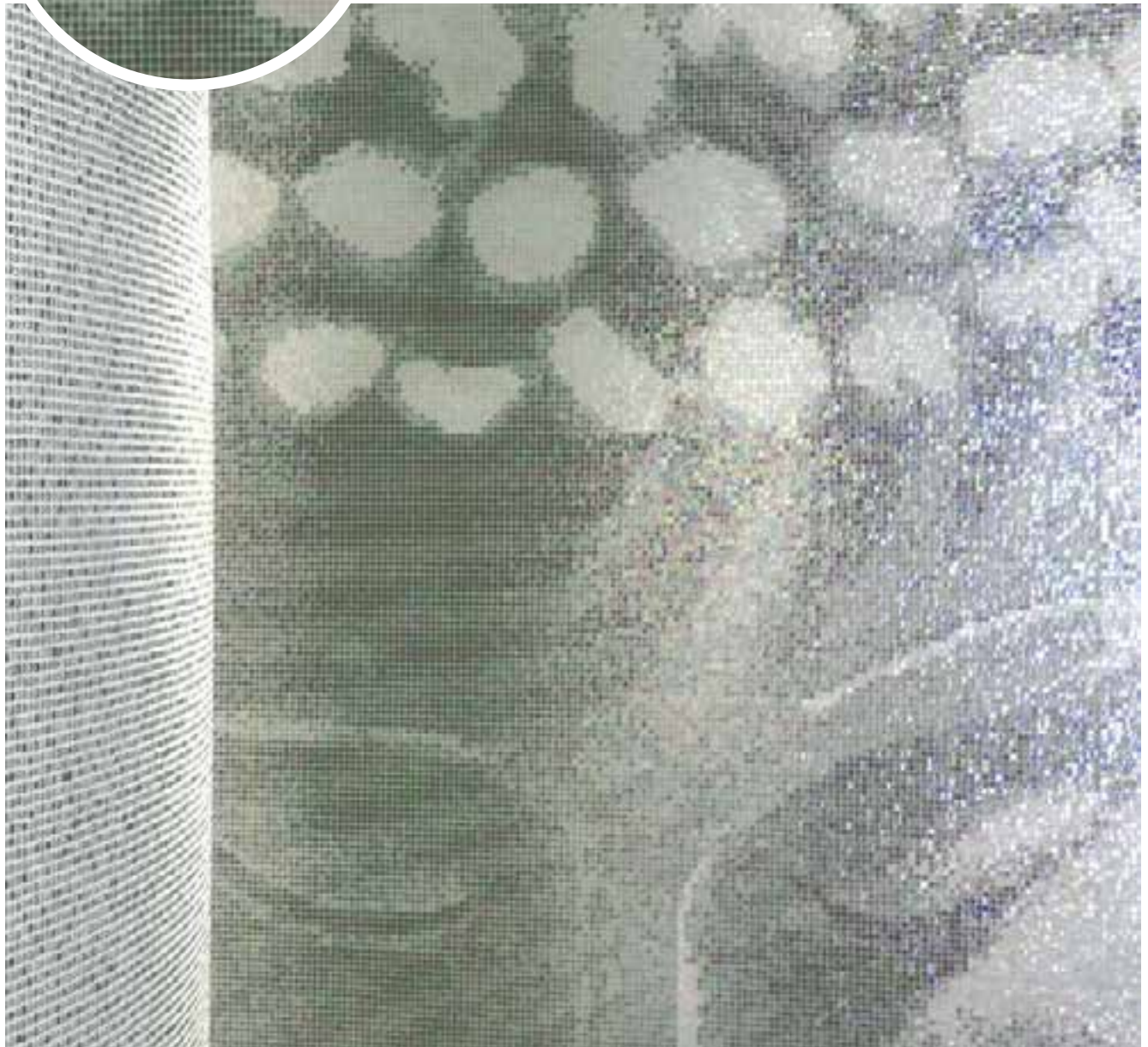

G-291*

*NOTE: The price groups are intended for guidance only and may vary depending on the size of the mosaic. Depending on the details of the drawing or photo, the measurements requested for the mosaic may vary, adapting to the size requirements so that the whole drawing or photo is visible. The smaller the size of the mosaic, the more difficult it is to adapt the drawing to the size.

**NOTA: Los grupos de precio son orientativos; dependiendo del tamaño del mosaico a realizar estos pueden variar. En función del detalle del dibujo o foto, las medidas solicitadas para el mosaico pueden variar ajustándose a la necesidad de tamaño para que se aprecie todo el dibujo o foto. Cuanto menores sean las medidas del mosaico solicitado, mayor dificultad para ajustar el dibujo de las mismas.*

**REMARQUES: Les gammes de prix sont données à titre indicatif; les prix peuvent varier en fonction de la taille de la mosaïque à réaliser. En fonction du détail du dessin ou de l'image, les mesures demandées pour la mosaïque peuvent varier afin de s'adapter aux besoins, en termes de dimensions, pour que l'ensemble du dessin ou de l'image soit visible. Plus les mesures de la mosaïque souhaitée seront réduites, plus il sera difficile d'y adapter le dessin.*

Customized Mosaics / Mosaicos Personalizados / Mosaïques Personnalisées

HIGH PRECISION SYSTEM

Customized mosaics made up of chips that can be cut and arranged in different shapes to achieve high-definition end results. These mosaics are classified into 3 groups, depending on how complex it is to cut the mosaic chips.

SISTEMA PRECISIÓN ALTA

Mosaico personalizado en el que las teselas que lo forman se pueden cortar y disponer en diferentes formas para conseguir una gran definición. Se dividen en tres categorías dependiendo del nivel de dificultad en los cortes de las teselas.

SYSTÈME HAUTE PRÉCISION

Mosaïque personnalisée dans laquelle les tesselles qui composent l'image peuvent être coupées et disposées de différentes manières pour obtenir une grande définition. Elle se classe en trois catégories en fonction du niveau de difficulté de coupe des tesselles.



G-299*

*NOTE: The price groups are intended for guidance only and may vary depending on the size of the mosaic. Depending on the details of the drawing or photo, the measurements requested for the mosaic may vary, adapting to the size requirements so that the whole drawing or photo is visible. The smaller the size of the mosaic, the more difficult it is to adapt the drawing to the size.

*NOTA: Los grupos de precio son orientativos; dependiendo del tamaño del mosaico a realizar estos pueden variar.

En función del detalle del dibujo o foto, las medidas solicitadas para el mosaico pueden variar ajustándose a la necesidad de tamaño para que se aprecie todo el dibujo o foto. Cuanto menores sean las medidas del mosaico solicitadas, mayor dificultad para ajustar el dibujo de las mismas.

*REMARQUES: Les gammes de prix sont données à titre indicatif; les prix peuvent varier en fonction de la taille de la mosaïque à réaliser.

En fonction du détail du dessin ou de l'image, les mesures demandées pour la mosaïque peuvent varier afin de s'adapter aux besoins, en termes de dimensions, pour que l'ensemble du dessin ou de l'image soit visible. Plus les mesures de la mosaïque souhaitée seront réduites, plus il sera difficile d'y adapter le dessin.

04



Ceramic Tiles



All L'Antic Colonial ceramic collections may be subject to variations in shade. The colour of the material supplied may differ slightly from that shown. Our website (<http://anticcolonial.com/en/ceramic/>) contains further information in respect of our ceramic products, such as installation guides and videos, technical specifications, details on textures or recommendations for use.

Todas las colecciones cerámicas de L'Antic Colonial pueden sufrir variaciones de tono. El color del material servido puede no ser exactamente igual al de la muestra.
En nuestra página web (<http://anticcolonial.com/ceramica/>) encontrará información adicional de nuestra cerámica como guías y vídeos de instalación, fichas técnicas, texturas o recomendaciones de uso.

Toutes les collections de céramique de L'Antic Colonial peuvent subir des variations de tonalité. La couleur du matériau fourni peut être légèrement différente de celle de l'échantillon. Sur notre site Internet (<http://anticcolonial.com/fr/ceramique/>), vous trouverez des informations supplémentaires sur notre céramique: manuels et vidéos d'installations, fiches techniques, textures ou recommandations d'utilisation.

04 Symbols / Descripción de Iconos / Description des Icones



IRREGULAR TEXTURE

Material that stands out for having an asymmetrical surface.

TEXTURA IRREGULAR

Material que destaca por tener una superficie asimétrica.

TEXTURE IRRÉGULIÈRE

Matériau qui se distingue par sa surface asymétrique.



GLOSS

Material with surface with the ability to produce reflections.

BRILLO

Material cuya superficie tiene la capacidad de producir reflejos.

ÉCLAT

Matériau dont la surface est en mesure de produire des reflets.



MATT

Material with a gloss-free surface.

MATE

Material cuya superficie carece de brillo.

MAT

Matériau dont la surface n'est pas brillante.



INDOOR WALL COVERING

Material suitable for use on indoor walls.

REVESTIMIENTO INTERIOR

Material apto para su uso en paredes de interior.

REVÊTEMENT INTÉRIEUR

Matériau qui convient aux murs d'intérieur.



SHOWER WALL COVERING

Material suitable for use on shower walls.

REVESTIMIENTO DUCHAS

Material apto para su uso en paredes de ducha.

REVÊTEMENT DOUCHES

Matériau qui convient aux murs de douches.



Wall Coverings Nazari Ifrane







Nazari

—
Marrakech
Asilah
Chauen
Fes
Iframe
Sale

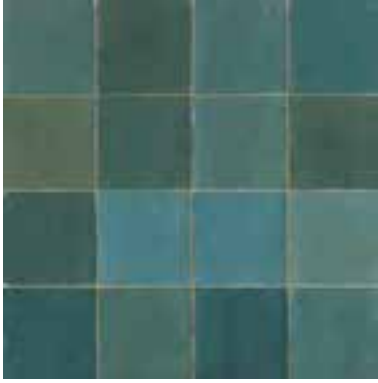

Nazari Chauen

11,5x11,5x1-1,1cm
4 4/8"x4 4/8"x3/8"

100213777 - L138001101 - G-231



Butech: Colorstuk 0-4 Gris

Pcs	m2	Kg
30 x Cj	0,40 x Cj	6,60 x Cj
2550 x Pal	33,72 x Pal	561 x Pal

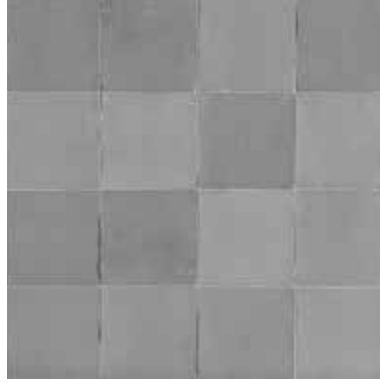

Nazari Sale

11,5x11,5x1-1,1cm
4 7/8"x4 7/8"x3/8"

100220354 - L138001131- G-231



Butech: Colorstuk 0-4 Gris

Pcs	m2	Kg
30 x Cj	0,40 x Cj	6,60 x Cj
2550 x Pal	33,72 x Pal	561 x Pal



Nazari Fes

11,5x11,5x1-1,1cm
4 7/8"x4 7/8"x3/8"

100213766 - L138001051 - G-231



Butech: Colorstuk 0-4 Gris

Pcs	m2	Kg
30 x Cj	0,40 x Cj	6,60 x Cj
2550 x Pal	33,72 x Pal	561 x Pal



Nazari Marrakech

11,5x11,5x1-1,1cm
4 4/8"x4 4/8"x3/8"

100213785 - L138001071 - G-231



Butech: Colorstuk 0-4 Marfil

Pcs	m2	Kg
30 x Cj	0,40 x Cj	6,60 x Cj
2550 x Pal	33,72 x Pal	561 x Pal



Nazari Asilah

11,5x11,5x1-1,1cm
4 4/8"x4 4/8"x3/8"

100213765 - L138001041 - G-231



Butech: Colorstuk 0-4 Beige

Pcs	m2	Kg
30 x Cj	0,40 x Cj	6,60 x Cj
2550 x Pal	33,72 x Pal	561 x Pal



Nazari Ifrane

11,5x11,5x1-1,1cm
4 4/8"x4 4/8"x3/8"

100213784 - L138001061 - G-231



Butech: Colorstuk 0-4 Gris

Pcs	m2	Kg
30 x Cj	0,40 x Cj	6,60 x Cj
2550 x Pal	33,72 x Pal	561 x Pal





Touch

—
Navy
Bottle
Pearl
Linen



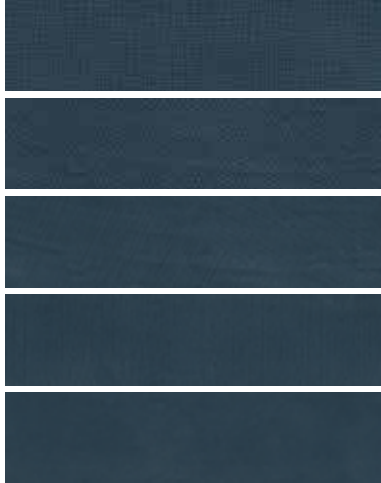

Touch Navy

7,5x30x0,8cm - 3"x11 3/4"x3/8"
100213767 - L138001081 - G-226



Butech: Colorstuk 0-4 Antracita

Pcs	m2	Kg
22 x Cj 2640 x Pal	0,49 x Cj 59,40 x Pal	6,55 x Cj 786,72 x Pal



Touch Bottle

7,5x30x0,8cm - 3"x11 3/4"x3/8"
100213811 - L138001091 - G-226



Butech: Colorstuk 0-4 Antracita

Pcs	m2	Kg
22 x Cj 2640 x Pal	0,49 x Cj 59,40 x Pal	6,55 x Cj 786,72 x Pal



Touch Pearl

7,5x30x0,8cm - 3"x11 3/4"x3/8"
100213787 - L138001111 - G-226



Butech: Colorstuk 0-4 Blanco

Pcs	m2	Kg
22 x Cj 2640 x Pal	0,49 x Cj 59,40 x Pal	6,55 x Cj 786,72 x Pal



Touch Linen

7,5x30x0,8cm - 3"x11 3/4"x3/8"
100213786 - L138001121 - G-226



Butech: Colorstuk 0-4 Blanco

Pcs	m2	Kg
22 x Cj 2640 x Pal	0,49 x Cj 59,40 x Pal	6,55 x Cj 786,72 x Pal



Each box contains flat pieces and pieces with the various textures in a random percentage / Cada caja contiene piezas lisas y piezas con las diferentes texturas en un porcentaje aleatorio / Chaque coisse contient des éléments unis et des éléments texturés distribués de façon aléatoire



Faces

-
- Blanco
- Negro
- Plata
- Oro

-



Faces H1 Blanco

12,9x14,9x0,8cm - 5 1/8"x5 7/8"x3/8"
100172936 - L138000271 - G-101



MATT



INDOOR
WALL
COVERING



SHOWER
WALL
COVERINGS

Butech: Colorstuk 0-4 Blanco

Pcs	m2	Kg
30 x Cj	0,58 x Cj	8,04 x Cj
2250 x Pal	43,50 x Pal	603,00 x Pal



Faces H1 Negro

12,9x14,9x0,8cm - 5 1/8"x5 7/8"x3/8"
100172928 - L138000281 - G-101



MATT



INDOOR
WALL
COVERING



SHOWER
WALL
COVERINGS

No supported grouting / No admite rejuntado /
Ne peut pas être jointoyé

Pcs	m2	Kg
30 x Cj	0,58 x Cj	8,04 x Cj
2250 x Pal	43,50 x Pal	603,00 x Pal



Faces H4 Blanco

12,9x14,9x0,8-2,4cm - 5 1/8"x5 7/8"x3/8"-1"
100172929 - L138000381 - G102



MATT



IRREGULAR
TEXTURE



INDOOR
WALL
COVERING



SHOWER
WALL
COVERINGS

Butech: Colorstuk 0-4 Blanco

Pcs	m2	Kg
20 x Cj	0,38 x Cj	7,12 x Cj
240 x Pal	4,61 x Pal	85,44 x Pal



Faces H2 Blanco

12,9x14,9x0,8-2cm - 5 1/8"x5 7/8"x3/8"-3/4"
100172937 - L138000251 - G-104



MATT



INDOOR
WALL
COVERING



SHOWER
WALL
COVERINGS

Butech: Colorstuk 0-4 Blanco

Pcs	m2	Kg
17 x Cj	0,33 x Cj	5,80 x Cj
204 x Pal	3,92 x Pal	69,56 x Pal

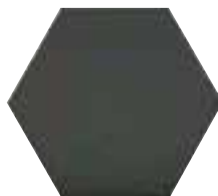

Faces H2 Negro

12,9x14,9x0,8-2cm - 5 1/8"x5 7/8"x3/8"-3/4"
100172955 - L138000371 - G-104



MATT



INDOOR
WALL
COVERING

No supported grouting / No admite rejuntado /
Ne peut pas être jointoyé

Pcs	m2	Kg
17 x Cj	0,33 x Cj	5,80 x Cj
204 x Pal	3,92 x Pal	69,56 x Pal

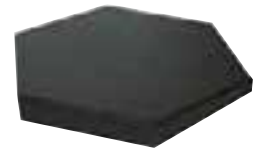

H2 side view / Vista lateral H2 / Vue de côté H2

Faces



Faces H1 Negro

12,9x14,9x0,8-2,4cm - 5 1/8"x5 7/8"x3/8"-1"
100172947 - L138000301- G-102



MATT



IRREGULAR
TEXTURE



INDOOR
WALL
COVERING



SHOWER
WALL
COVERINGS

Butech: Colorstuk 0-4 Black

Pcs	m2	Kg
20 x Cj	0,38 x Cj	7,12 x Cj
240 x Pal	4,61 x Pal	85,44 x Pal



Faces H1 Plata

12,9x14,9x0,8-2,4cm - 5 1/8"x5 7/8"x3/8"-1"
100172956 - L138000351 - G-108



GLOSS



IRREGULAR
TEXTURE



INDOOR
WALL
COVERING



SHOWER
WALL
COVERINGS

Butech: Colorstuk 0-4 Manhattan

Pcs	m2	Kg
20 x Cj	0,38 x Cj	7,12 x Cj
360 x Pal	6,92 x Pal	128,16 x Pal



Faces H4 Oro

12,9x14,9x0,8-2,4cm - 5 1/8"x5 7/8"x3/8"-1"
100172948 - L138000291 - G108



GLOSS



IRREGULAR
TEXTURE



INDOOR
WALL
COVERING



SHOWER
WALL
COVERINGS

Butech: Colorstuk 0-4 Bahama

Pcs	m2	Kg
20 x Cj	0,38 x Cj	7,12 x Cj
240 x Pal	4,61 x Pal	85,44 x Pal



Wall Coverings Faces H2 Negro

-

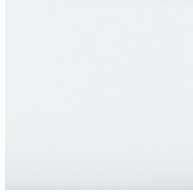

Faces S1 Blanco

12,5x12,5x0,8cm - 4 7/8"x4 7/8"x3/8"
100172949 - L138000401 - G-101



MATT



INDOOR
WALL
COVERING



SHOWER
WALL
COVERINGS

Butech: Colorstuk 0-4 Blanco

Pcs	m2	Kg
36 x Cj	0,56 x Cj	7,45 x Cj
432 x Pal	6,75 x Pal	89,42 x Pal



Faces S3 Blanco

12,5x12,5x0,8-2,4cm - 4 7/8"x4 7/8"x3/8"-1"
100172938 - L138000261 - G-102



MATT



IRREGULAR
TEXTURE



INDOOR
WALL
COVERING



SHOWER
WALL
COVERINGS

Butech: Colorstuk 0-4 Blanco

Pcs	m2	Kg
12 x Cj	0,16 x Cj	2,85 x Cj
120 x Pal	1,88 x Pal	34,20 x Pal



Faces S4 Blanco

12,5x12,5x0,8-2,4cm - 4 7/8"x4 7/8"x3/8"-1"
100172970 - L138000321 - G-102



MATT



IRREGULAR
TEXTURE



INDOOR
WALL
COVERING



SHOWER
WALL
COVERINGS

Butech: Colorstuk 0-4 Blanco

Pcs	m2	Kg
10 x Cj	0,16 x Cj	2,75 x Cj
120 x Pal	1,88 x Pal	33,00 x Pal



Faces S1 Negro

12,5x12,5x0,8cm - 4 7/8"x4 7/8"x3/8"
100172957 - L138000331 - G-101



MATT



INDOOR
WALL
COVERING



SHOWER
WALL
COVERINGS

Butech: Colorstuk 0-4 Negro

Pcs	m2	Kg
36 x Cj	0,56 x Cj	7,45 x Cj
432 x Pal	6,75 x Pal	89,42 x Pal



Faces S3 Negro

12,5x12,5x0,8-2,4cm - 4 7/8"x4 7/8"x3/8"-1"
100172939 - L138000361 - G-102



MATT



IRREGULAR
TEXTURE



INDOOR
WALL
COVERING



SHOWER
WALL
COVERINGS

Butech: Colorstuk 0-4 Negro

Pcs	m2	Kg
12 x Cj	0,16 x Cj	2,85 x Cj
120 x Pal	1,88 x Pal	34,20 x Pal

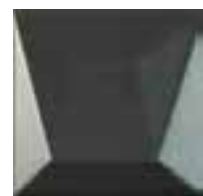

Faces S4 Negro

12,5x12,5x0,8-2,4cm - 4 7/8"x4 7/8"x3/8"-1"
100172980 - L138000411 - G-102



MATT



IRREGULAR
TEXTURE



INDOOR
WALL
COVERING



SHOWER
WALL
COVERINGS

Butech: Colorstuk 0-4 Negro

Pcs	m2	Kg
10 x Cj	0,16 x Cj	2,75 x Cj
120 x Pal	1,88 x Pal	33,00 x Pal

Faces



Faces S3 Oro

12,5x12,5x0,8-2,4cm - 4 7/8"x4 7/8"x3/8"-1"
100172958 - L138000421- G-108



GLOSS

IRREGULAR
TEXTURE

INDOOR
WALL
COVERING

SHOWER
WALL
COVERINGS

Butech: Colorstuk 0-4 Beige

Pcs	m2	Kg
10 x Cj	0,16 x Cj	2,85 x Cj
120 x Pal	1,88 x Pal	34,20 x Pal



Faces S3 Plata

12,5x12,5x0,8-2,4cm - 4 7/8"x4 7/8"x3/8"-1"
100172960 - L138000391- G-108



GLOSS

IRREGULAR
TEXTURE

INDOOR
WALL
COVERING

SHOWER
WALL
COVERINGS

Butech: Colorstuk 0-4 Manhattan

Pcs	m2	Kg
10 x Cj	0,16 x Cj	2,85 x Cj
120 x Pal	1,88 x Pal	34,20 x Pal

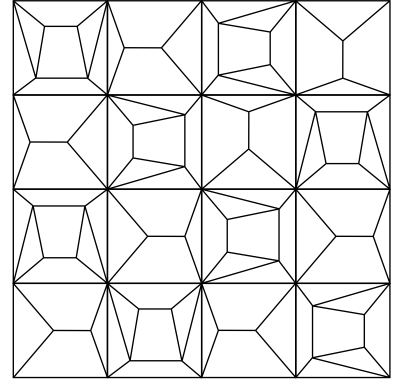

FACES S3/S4 RANDOM POSITIONING.
To achieve this effect, both Ref. S3 and S4 should be used in the installation.

COLOCACIÓN ALEATORIA DE FACES S3/S4.
Para conseguir este efecto, es necesario combinar las referencias S3 y S4 en la instalación.

POSE ALÉATOIRE DE FACES S3/S4.
Pour obtenir cet effet, il est nécessaire de combiner les références S3 et S4 lors de l'installation.



Faces S4 Oro

12,5x12,5x0,8-2,4cm - 4 7/8"x4 7/8"x3/8"-1"
100172971 - L138000311- G-108



GLOSS

IRREGULAR
TEXTURE

INDOOR
WALL
COVERING

SHOWER
WALL
COVERINGS

Butech: Colorstuk 0-4 Beige

Pcs	m2	Kg
10 x Cj	0,16 x Cj	2,75 x Cj
120 x Pal	1,88 x Pal	33,00 x Pal



Faces S4 Plata

12,5x12,5x0,8-2,4cm - 4 7/8"x4 7/8"x3/8"-1"
100172959 - L138000341- G-108



GLOSS

IRREGULAR
TEXTURE

INDOOR
WALL
COVERING

SHOWER
WALL
COVERINGS

Butech: Colorstuk 0-4 Manhattan

Pcs	m2	Kg
10 x Cj	0,16 x Cj	2,75 x Cj
120 x Pal	1,88 x Pal	33,00 x Pal

Signature

—
White
Cream
Copper
Silver
Mud
Shell
Smoke

Wall Coverings Signature Cream Matt, Signature Shell, Signature Mud



-



Signature Tile White Glossy

7,5x15 cm - 3"x5 7/8"

100178896 - L138000611- G-226



GLOSS



INDOOR
WALL
COVERING



SHOWER
WALL
COVERINGS

Butech: Colorstuk 0-4 Blanco

Pcs	m2	Kg
44 x Cj	0,49 x Cj	8,01 x Cj
4840 x Pal	54,45 x Pal	880,88 x Pal



Signature Tile White Matt

7,5x15 cm - 3"x5 7/8"

100178903 - L138000641- G-226



MATT



INDOOR
WALL
COVERING



SHOWER
WALL
COVERINGS

Butech: Colorstuk 0-4 Blanco

Pcs	m2	Kg
44 x Cj	0,49 x Cj	8,01 x Cj
4840 x Pal	54,45 x Pal	880,88 x Pal



Signature Tile Cream Glossy

7,5x15 cm - 3"x5 7/8"

100178876 - L138000631- G-226



GLOSS



INDOOR
WALL
COVERING



SHOWER
WALL
COVERINGS

Butech: Colorstuk 0-4 Beige

Pcs	m2	Kg
44 x Cj	0,49 x Cj	8,01 x Cj
4840 x Pal	54,45 x Pal	880,88 x Pal

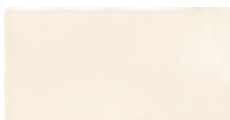

Signature Tile Cream Matt

7,5x15 cm - 3"x5 7/8"

100178902 - L138000621- G-226



MATT



INDOOR
WALL
COVERING



SHOWER
WALL
COVERINGS

Butech: Colorstuk 0-4 Beige

Pcs	m2	Kg
44 x Cj	0,49 x Cj	8,01 x Cj
4840 x Pal	54,45 x Pal	880,88 x Pal



Signature Tile Copper

7,5x15 cm - 3"x5 7/8"

100178911 - L138000651- G-237



GLOSS



INDOOR
WALL
COVERING



SHOWER
WALL
COVERINGS

Butech: Colorstuk 0-4 Moka

Pcs	m2	Kg
44 x Cj	0,49 x Cj	8,01 x Cj
4840 x Pal	54,45 x Pal	880,88 x Pal



Signature Tile Silver

7,5x15 cm - 3"x5 7/8"

100178877 - L138000661- G-237



GLOSS



INDOOR
WALL
COVERING



SHOWER
WALL
COVERINGS

Butech: Colorstuk 0-4 Antracita

Pcs	m2	Kg
44 x Cj	0,49 x Cj	8,01 x Cj
4840 x Pal	54,45 x Pal	880,88 x Pal

Signature



Signature Tile Mud

7,5x15 cm - 3"x5 7/8"

100178878 - L138000671- G-226



MATT



INDOOR
WALL
COVERING



SHOWER
WALL
COVERINGS

Butech: Colorstuk 0-4 Cemento

Pcs	m2	Kg
44 x Cj	0,49 x Cj	8,01 x Cj
4840 x Pal	54,45 x Pal	880,88 x Pal



Signature Tile Shell

7,5x15 cm - 3"x5 7/8"

100178912 - L138000681- G-226



MATT



INDOOR
WALL
COVERING



SHOWER
WALL
COVERINGS

Butech: Colorstuk 0-4 Beige

Pcs	m2	Kg
44 x Cj	0,49 x Cj	8,01 x Cj
4840 x Pal	54,45 x Pal	880,88 x Pal



Signature Tile Smoke

7,5x15 cm - 3"x5 7/8"

100178904 - L138000691- G-226



MATT



INDOOR
WALL
COVERING



SHOWER
WALL
COVERINGS

Butech: Colorstuk 0-4 Manhattan

Pcs	m2	Kg
44 x Cj	0,49 x Cj	8,01 x Cj
4840 x Pal	54,45 x Pal	880,88 x Pal



Wall Coverings Signature Smoke



Ibiza

—
Snow
Concrete
White
Steel
Grey
Dark

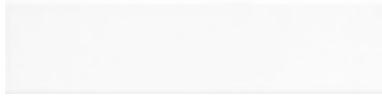

Ibiza Snow

10x40 cm - 3 7/8"x15 3/4"
100183800 - L138000751- G-226



MATT



INDOOR
WALL
COVERING



SHOWER
WALL
COVERINGS

Butech: Colorstuk 0-4 Blanco

Pcs	m2	Kg
25 x Cj	1,00 x Cj	16,75 x Cj
1500 x Pal	60,00 x Pal	1005 x Pal



Ibiza White

10x40 cm - 3 7/8"x15 3/4"
100183797 - L138000741- G-226



MATT



INDOOR
WALL
COVERING



SHOWER
WALL
COVERINGS

Butech: Colorstuk 0-4 Blanco

Pcs	m2	Kg
25 x Cj	1,00 x Cj	16,75 x Cj
1500 x Pal	60,00 x Pal	1005 x Pal



Ibiza Grey

10x40 cm - 3 7/8"x15 3/4"
100183769 - L138000711- G-226



MATT



INDOOR
WALL
COVERING



SHOWER
WALL
COVERINGS

Butech: Colorstuk 0-4 Gris

Pcs	m2	Kg
25 x Cj	1,00 x Cj	16,75 x Cj
1500 x Pal	60,00 x Pal	1005 x Pal



Ibiza Concrete

10x40 cm - 3 7/8"x15 3/4"
100183787 - L138000721- G-226



MATT



INDOOR
WALL
COVERING



SHOWER
WALL
COVERINGS

Butech: Colorstuk 0-4 Beige

Pcs	m2	Kg
25 x Cj	1,00 x Cj	16,75 x Cj
1500 x Pal	60,00 x Pal	1005 x Pal



Ibiza Steel

10x40 cm - 3 7/8"x15 3/4"
100183796 - L138000731- G-226



MATT



INDOOR
WALL
COVERING



SHOWER
WALL
COVERINGS

Butech: Colorstuk 0-4 Gris

Pcs	m2	Kg
25 x Cj	1,00 x Cj	16,75 x Cj
1500 x Pal	60,00 x Pal	1005 x Pal



Ibiza Dark

10x40 cm - 3 7/8"x15 3/4"
100183768 - L138000701- G-226



MATT



INDOOR
WALL
COVERING



SHOWER
WALL
COVERINGS

Butech: Colorstuk 0-4 Cemento

Pcs	m2	Kg
25 x Cj	1,00 x Cj	16,75 x Cj
1500 x Pal	60,00 x Pal	1005 x Pal

Ibiza

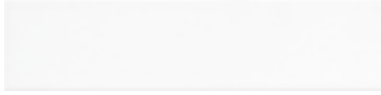

Ibiza Snow Gloss

10x40 cm - 3 7/8"x15 3/4"

100184163 - L138000791 - G-226



GLOSS



INDOOR
WALL
COVERING



SHOWER
WALL
COVERINGS

Butech: Colorstuk 0-4 Blanco

Pcs	m2	Kg
25 x Cj	1,00 x Cj	16,75 x Cj
1500 x Pal	60,00 x Pal	1005 x Pal



Ibiza White Gloss

10x40 cm - 3 7/8"x15 3/4"

100184180 - L138000811 - G-226



GLOSS



INDOOR
WALL
COVERING



SHOWER
WALL
COVERINGS

Butech: Colorstuk 0-4 Blanco

Pcs	m2	Kg
25 x Cj	1,00 x Cj	15,07 x Cj
1500 x Pal	60,00 x Pal	904,50 x Pal



Ibiza Grey Gloss

10x40 cm - 3 7/8"x15 3/4"

100184170 - L138000801 - G-226



GLOSS



INDOOR
WALL
COVERING



SHOWER
WALL
COVERINGS

Butech: Colorstuk 0-4 Gris

Pcs	m2	Kg
25 x Cj	1,00 x Cj	16,75 x Cj
1500 x Pal	60,00 x Pal	1005 x Pal



Ibiza Concrete Gloss

10x40 cm - 3 7/8"x15 3/4"

100184153 - L138000761 - G-226



GLOSS



INDOOR
WALL
COVERING



SHOWER
WALL
COVERINGS

Butech: Colorstuk 0-4 Beige

Pcs	m2	Kg
25 x Cj	1,00 x Cj	16,75 x Cj
1500 x Pal	60,00 x Pal	1005 x Pal



Ibiza Steel Gloss

10x40 cm - 3 7/8"x15 3/4"

100184164 - L138000781 - G-226



GLOSS



INDOOR
WALL
COVERING



SHOWER
WALL
COVERINGS

Butech: Colorstuk 0-4 Gris

Pcs	m2	Kg
25 x Cj	1,00 x Cj	16,75 x Cj
1500 x Pal	60,00 x Pal	1005 x Pal

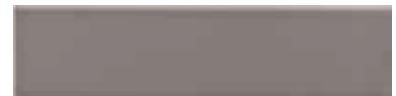

Ibiza Dark Gloss

10x40 cm - 3 7/8"x15 3/4"

100184162 - L138000771 - G-226



GLOSS



INDOOR
WALL
COVERING



SHOWER
WALL
COVERINGS

Butech: Colorstuk 0-4 Cemento

Pcs	m2	Kg
25 x Cj	1,00 x Cj	16,75 x Cj
1500 x Pal	60,00 x Pal	1005 x Pal





Retro, Riverside

—
Retro Blanco
Riverside Gold
Riverside White

-

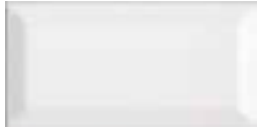

Retro Blanco

10x20 cm - 3 7/8"x7 7/8"
100000837 - L131501001 - G-218



Butech: Colorstuk 0-4 Blanco

Pcs	m2	Kg
50 x Cj 3000 x Pal	1 x Cj 60 x Pal	16,25 x Cj 975 x Pal



Romo Retro Blanco

10x20 cm - 3 7/8"x7 7/8"
100000850 - L131550001 - G-102



Butech: Colorstuk 0-4 Blanco

Pcs	m2	Kg
50 x Cj 3000 x Pal	1 x Cj 60 x Pal	16,25 x Cj 975 x Pal



Bordura Bisel Blanco

10x20 cm - 3 7/8"x7 7/8"
100000906 - L133201001 - G-102

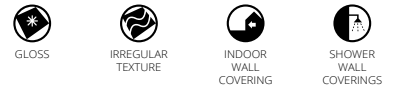

Butech: Colorstuk 0-4 Blanco

Pcs	m2	Kg
28 x Cj 4704 x Pal	0,28 x Cj 47,04 x Pal	4,23 x Cj 710,30 x Pal

Ceramic tile with rounded or oval edge, which therefore precludes using a moulding to finish.

Modelo cerámico con canto redondeado u ovalado, por lo que no puede terminarse con la moldura.

Modèle de céramique au bord arrondi ou ovale, qui ne peut donc pas se finir avec la moulure.



Bordura Bisel Blanco side view
Vista lateral Bordura Bisel Blanco
Vue de côté Bordura Bisel Blanco



Wall Coverings Retro Blanco

Riverside



Riverside Gold

10x30 cm - 3 7/8"x11 3/4"

100188898 - L138000841- G-226



GLOSS



INDOOR
WALL
COVERING



SHOWER
WALL
COVERINGS

Butech: Colorstuk 0-4 Blanco

Pcs	m2	Kg
16 x Cj	0,48 x Cj	7,55 x Cj
1632 x Pal	48,96 x Pal	770,30 x Pal



Riverside White

10x30 cm - 3 7/8"x11 3/4"

100188920 - L138000851- G-226



GLOSS



INDOOR
WALL
COVERING



SHOWER
WALL
COVERINGS

Butech: Colorstuk 0-4 Blanco

Pcs	m2	Kg
16 x Cj	0,48 x Cj	7,55 x Cj
1632 x Pal	48,96 x Pal	770,30 x Pal



Wall Coverings Riverside Gold

Mediterranea

Black
Concrete
Warmgrey
Blanco
Nieve
Seagreen





Javae Black

20x20 - 7 7/8"x7 7/8"

100174485 - L138000521 - G-222



GLOSS



INDOOR
WALL
COVERING



SHOWER
WALL
COVERINGS

Butech: Colorstuk 0-4 Negro

Pcs	m2	Kg
25 x Cj	1 x Cj	16,78 x Cj
1500 x Pal	60 x Pal	1006,50 x Pal



Calpe Black

7,5x30 - 3"x11 3/4"

100174467 - L138000591 - G-226



GLOSS



INDOOR
WALL
COVERING



SHOWER
WALL
COVERINGS

Butech: Colorstuk 0-4 Negro

Pcs	m2	Kg
22 x Cj	0,5 x Cj	8,60 x Cj
2420 x Pal	54,45 x Pal	946,22 x Pal



Denia Black

5x30 - 2"x11 3/4"

100174439 - L138000431 - G-226



GLOSS



INDOOR
WALL
COVERING



SHOWER
WALL
COVERINGS

Butech: Colorstuk 0-4 Negro

Pcs	m2	Kg
33 x Cj	0,5 x Cj	8,32 x Cj
3630 x Pal	54,45 x Pal	914,76 x Pal



Javae Blanco

20x20 - 7 7/8"x7 7/8"

100174486 L138000551 - G-222



GLOSS



INDOOR
WALL
COVERING



SHOWER
WALL
COVERINGS

Butech: Colorstuk 0-4 Blanco

Pcs	m2	Kg
25 x Cj	1 x Cj	16,78 x Cj
1500 x Pal	60 x Pal	1006,50 x Pal

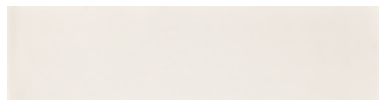

Calpe Blanco

7,5x30 - 3"x11 3/4"

100174475 - L138000561 - G-226



GLOSS



INDOOR
WALL
COVERING



SHOWER
WALL
COVERINGS

Butech: Colorstuk 0-4 Blanco

Pcs	m2	Kg
22 x Cj	0,5 x Cj	8,60 x Cj
2420 x Pal	54,45 x Pal	946,22 x Pal

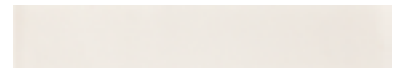

Denia Blanco

5x30 - 2"x11 3/4"

100174483 - L138000441 - G-226



GLOSS



INDOOR
WALL
COVERING



SHOWER
WALL
COVERINGS

Butech: Colorstuk 0-4 Blanco

Pcs	m2	Kg
33 x Cj	0,5 x Cj	8,32 x Cj
3630 x Pal	54,45 x Pal	914,76 x Pal

Mediterranea

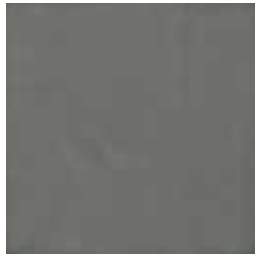

Javae Concrete

20x20 - 7 7/8"x7 7/8"

100174468 - L138000571 - G-222



GLOSS



INDOOR
WALL
COVERING



SHOWER
WALL
COVERINGS

Butech: Colorstuk 0-4 Antracita

Pcs	m2	Kg
25 x Cj	1 x Cj	16,78 x Cj
1500 x Pal	60 x Pal	1006,50 x Pal

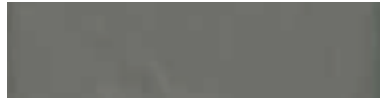

Calpe Concrete

7,5x30 - 3"x11 3/4"

100174481 - L138000501 - G-226



GLOSS



INDOOR
WALL
COVERING



SHOWER
WALL
COVERINGS

Butech: Colorstuk 0-4 Antracita

Pcs	m2	Kg
22 x Cj	0,5 x Cj	8,60 x Cj
2420 x Pal	54,45 x Pal	946,22 x Pal



Denia Concrete

5x30 - 2"x11 3/4"

100174490 - L138000451 - G-226



GLOSS



INDOOR
WALL
COVERING



SHOWER
WALL
COVERINGS

Butech: Colorstuk 0-4 Antracita

Pcs	m2	Kg
33 x Cj	0,5 x Cj	8,32 x Cj
3630 x Pal	54,45 x Pal	914,76 x Pal



Javae Nieve

20x20 - 7 7/8"x7 7/8"

100174487 - L138000531 - G-222



GLOSS



INDOOR
WALL
COVERING



SHOWER
WALL
COVERINGS

Butech: Colorstuk 0-4 Blanco

Pcs	m2	Kg
25 x Cj	1 x Cj	16,78 x Cj
1500 x Pal	60 x Pal	1006,50 x Pal

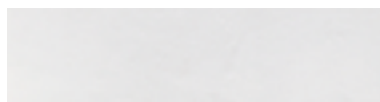

Calpe Nieve

7,5x30 - 3"x11 3/4"

100174476 - L138000511 - G-226



GLOSS



INDOOR
WALL
COVERING



SHOWER
WALL
COVERINGS

Butech: Colorstuk 0-4 Blanco

Pcs	m2	Kg
22 x Cj	0,5 x Cj	8,60 x Cj
2420 x Pal	54,45 x Pal	946,22 x Pal



Denia Nieve

5x30 - 2"x11 3/4"

100174491 - L138000461 - G-226



GLOSS



INDOOR
WALL
COVERING



SHOWER
WALL
COVERINGS

Butech: Colorstuk 0-4 Blanco

Pcs	m2	Kg
33 x Cj	0,5 x Cj	8,32 x Cj
3630 x Pal	54,45 x Pal	914,76 x Pal

-



Javae Warmgrey

20x20 - 7 7/8"x7 7/8"

100174469 - L138000541 - G-222



GLOSS



INDOOR
WALL
COVERING



SHOWER
WALL
COVERINGS

Butech: Colorstuk 0-4 Beige

Pcs	m2	Kg
25 x Cj	1 x Cj	16,78 x Cj
1500 x Pal	60 x Pal	1006,50 x Pal

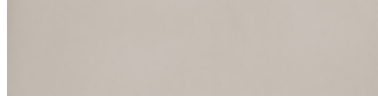

Calpe Warmgrey

7,5x30 - 3"x11 3/4"

100174482 - L138000581 - G-226



GLOSS



INDOOR
WALL
COVERING



SHOWER
WALL
COVERINGS

Butech: Colorstuk 0-4 Beige

Pcs	m2	Kg
22 x Cj	0,5 x Cj	8,60 x Cj
2420 x Pal	54,45 x Pal	946,22 x Pal



Denia Warmgrey

5x30 - 2"x11 3/4"

100174492 - L138000481 - G-226



GLOSS



INDOOR
WALL
COVERING



SHOWER
WALL
COVERINGS

Butech: Colorstuk 0-4 Beige

Pcs	m2	Kg
33 x Cj	0,5 x Cj	8,32 x Cj
3630 x Pal	54,45 x Pal	914,76 x Pal



Javae Seagreen

20x20 - 7 7/8"x7 7/8"

100174477 - L138000491 - G-222



GLOSS



INDOOR
WALL
COVERING



SHOWER
WALL
COVERINGS

Butech: Colorstuk 0-4 Gris

Pcs	m2	Kg
25 x Cj	1 x Cj	16,78 x Cj
1500 x Pal	60 x Pal	1006,50 x Pal



Calpe Seagreen

7,5x30 - 3"x11 3/4"

100174438 - L138000601 - G-226



GLOSS



INDOOR
WALL
COVERING



SHOWER
WALL
COVERINGS

Butech: Colorstuk 0-4 Gris

Pcs	m2	Kg
22 x Cj	0,5 x Cj	8,60 x Cj
2420 x Pal	54,45 x Pal	946,22 x Pal



Denia Seagreen

5x30 - 2"x11 3/4"

100174484 - L138000471 - G-226



GLOSS



INDOOR
WALL
COVERING



SHOWER
WALL
COVERINGS

Butech: Colorstuk 0-4 Gris

Pcs	m2	Kg
33 x Cj	0,5 x Cj	8,32 x Cj
3630 x Pal	54,45 x Pal	914,76 x Pal



1. RECEPTION OF MATERIAL

1. RECEPCIÓN DEL MATERIAL

1. RÉCEPTION DU MATÉRIAU

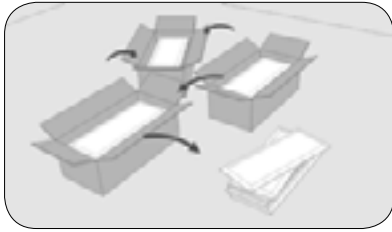

Mix pieces from different boxes to achieve a uniform look.

Mezclar piezas de cajas diferentes para conseguir un efecto estético homogéneo.

Mélanger les pièces de boîtes différentes pour une esthétique homogène.



Open and check each box before installation. In order for a tile defect claim to be valid, it must be detected before installation.

Abrir y revisar cada caja antes de su colocación. Para que una reclamación sea procedente por defecto de la baldosa se debe detectar antes de su instalación.

Ouvrir et réviser chaque boîte avant la pose. Pour qu'une réclamation soit jugée fondée à cause d'un défaut du carreau, il faut le détecter avant la pose.

2. INSTALLATION SURFACE

2. SUPERFICIE DE COLOCACIÓN

2. SURFACE DE POSE MATÉRIAU



Completely clean and dry before starting.

Completamente limpia y seca antes de comenzar.

La surface doit être complètement propre et sèche avant d'initier l'installation.

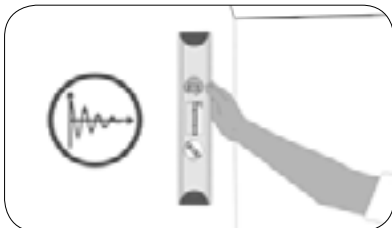

It shall be flat and stable.

Debe ser plana y estable.

Elle doit être plate et stable.

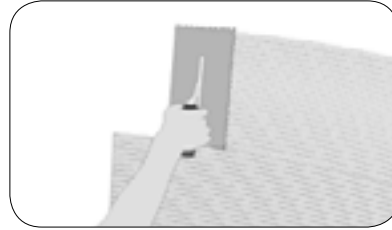

Apply the adhesive throughout the installation surface (in case of double bonding, also on the back of the pieces). We recommend One-Flex by Butech.

Aplicar el adhesivo por toda la superficie de colocación (en caso de doble encolado también al dorso de las piezas). Se recomienda One-Flex de Butech.

Appliquer l'adhésif sur toute la surface de pose (en cas de double collage, il faut aussi l'appliquer sur le revers des pièces). Nous recommandons l'utilisation de One-Flex de Butech.

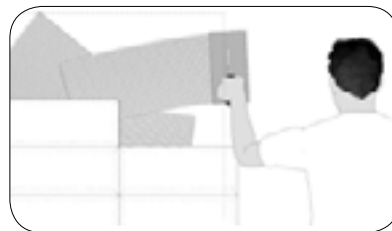

Work in reduced areas.

Trabajar en zonas de extensión reducida.

Travailler sur des zones réduites.

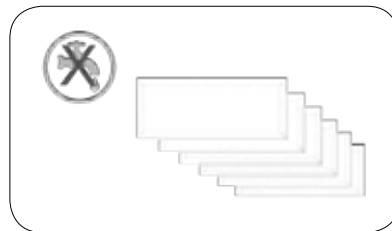

Do not wet the pieces before installing.

No mojar las piezas antes de colocarlas.

Ne pas mouiller les pièces avant la pose.

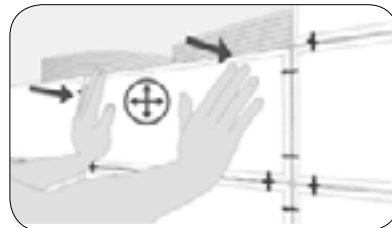

Leave the required joint using spacers, pressing and making a slight back and forth movement for greater coverage on the back.

Dejar la junta necesaria, con distanciadores, presionando y ejerciendo un pequeño movimiento de

vaivén para una mayor cobertura del dorso.

Laisser le joint nécessaire, à l'aide d'entretoises, en pressant et en exerçant un petit mouvement d'oscillation pour une plus grande couverture du revers.

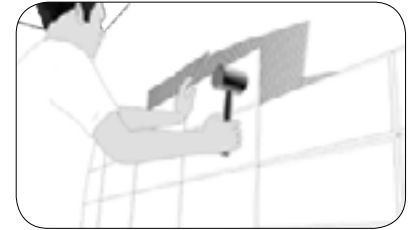

Carry out the settling of the pieces using a rigid and clean rubber plate, and beating on it with a rubber mallet.

Realizar el asentamiento de las piezas con una plancha de goma rígida y limpia, batiendo con un martillo de goma.

Affaisser les pièces avec une planche en caoutchouc rigide et propre, en les martelant avec un marteau en caoutchouc.

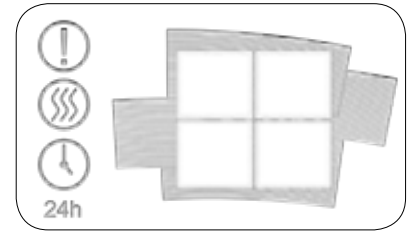

Let the adhesive dry for at least 24-48h. Before the adhesive dries, remove its remains with a sponge or cloth.

Dejar secar el adhesivo al menos 24-48h. Antes de que fragüe el adhesivo, retirar los restos con una esponja o un trapo.

Laisser l'adhésif sécher pendant au moins 24 à 48h. Avant la prise de l'adhésif, retirer les excédents à l'aide d'une éponge ou d'un chiffon.

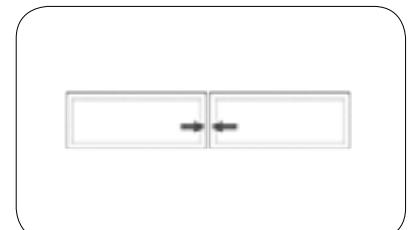

Minimum joint of 2mm.

Junta mínima de 2mm.

Joint d'un minimum de 2mm.

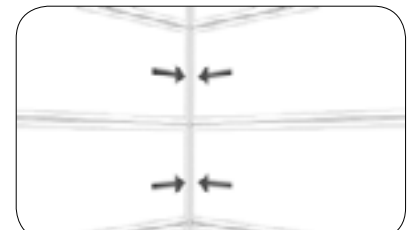

Take into account the perimeter joints at intersections and level

Installation / Instalación / Installation

changes.

Tener en cuenta juntas perimetrales en los encuentros y cambios de plano.

Tenir compte des joints périphériques sur les rencontres et les changements de plan.

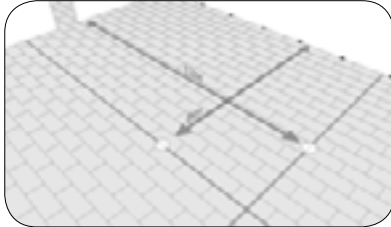

Intermediate joints every 8m, with a minimum width of 6mm.

Juntas intermedias cada 8m, teniendo una anchura mínima de 6mm.

Joints intermédiaires tous les 8m, avec une largeur minimale de 6mm.

GROUTING (applicable only ceramic tile with joint)

REJUNTADO (aplicable sólo cerámica con junta)

REJOINTOEMENT (applicable uniquement céramique avec joint)

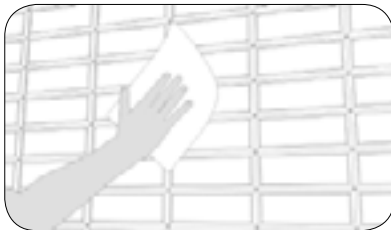

Perfectly clean pieces, and free from dust residue before grouting.

Piezas perfectamente limpias y sin restos de residuos de polvo antes de proceder al rejuntado.

Pièces parfaitement propres et sans poussière avant la phase de réalisation des joints.



We recommend Butech's Colorstuk.

Se recomienda Colorstuk de Butech.

L'utilisation de Colorstuk de Butech est recommandée.

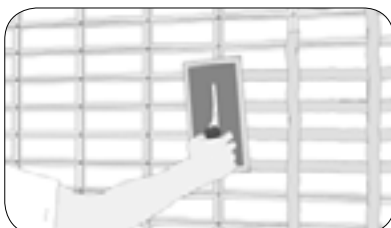

Spread the material with a rubber trowel, filling joints well.

Extender el material con una llana de goma rellenando bien las juntas.

Étaler le matériel avec une truelle en caoutchouc en remplissant bien les joints.

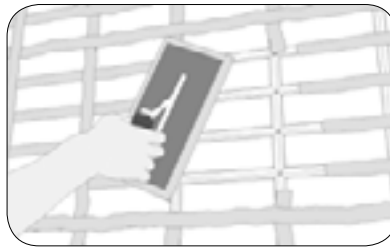

Use the same trowel to remove excess grout.

Utilizar la misma llana para eliminar el exceso.

Utiliser la même truelle pour éliminer le produit excédant.



Before the material dries, remove its remains with a sponge or cloth.

Antes de que fragüe el material, retirar los restos con una esponja o trapo.

Avant la prise du matériel, retirer les excédents à l'aide d'une éponge ou d'un chiffon.

You can see these updated installation instructions by visiting our website www.anticcolonial.com

Puedes revisar estas instrucciones de instalación actualizadas y con más detalle visitando nuestra página web www.anticcolonial.com

Pour réviser ces instructions d'installation, mises à jour et plus détaillées, veuillez visiter notre site Internet www.anticcolonial.com



Wall Coverings Signature Copper

05
|



Floor Coverings Downtown Grey Payne / Wall Coverings Amsterdam Hexagon White

Natural Wood



All L'Antic Colonial wood products may be subject to variations in shade. The colour of the material supplied may differ slightly from that shown.

Our website (<http://anticcolonial.com/en/natural-wood/>) contains further information in respect of our parquets, such as installation guides and videos, technical specifications, details on textures and recommendations for use and maintenance.

Todas las maderas de L'Antic Colonial son productos naturales que pueden sufrir variaciones de tono. El color del material servido puede no ser exactamente igual al de la muestra.

En nuestra página web (<http://anticcolonial.com/madera-natural/>) encontrará información adicional de nuestros parquets como guías y vídeos de instalación, fichas técnicas, consejos para su mantenimiento, texturas o recomendaciones de uso.

Tous les bois de L'Antic Colonial sont des produits naturels qui peuvent subir des variations de tonalité. La couleur du matériau fourni peut être légèrement différente de celle de l'échantillon.

Sur notre site Internet (<http://anticcolonial.com/fr/bois-naturel/>), vous trouverez des informations supplémentaires sur nos parquets: manuels et vidéos d'installations, conseils pour l'entretien, textures ou recommandations d'utilisation.



REMEMBER

All natural products are perfectly imperfect. The differences found between pieces make each piece unique and unrepeatable. This feature is NOT A PRODUCT DEFECT but an inherent part of the beauty of the product.

If we are able to convey an understanding of the features of our products, we are sure that we will be able to meet all your expectations as regards quality and beauty. This is why it is essential that you are aware that you are buying a natural product, the characteristics of which may, on occasions, include:

1.- Knots filled with wood putty

The grain and knots of natural wood parquet are one of the principal features making each board unique, and forming part of the beauty of the product. They are filled with a wood putty as similar as possible to the tone of the wood, or with black wood putty depending on the model. Our catalogue contains further information about the size of the knots and the number that may appear.

2.- Changes in shade

All the natural products vary in shade and in the structure of the piece. The pieces undergo an exhaustive sorting process at L'Antic Colonial and any that do not meet our exacting quality standards are rejected. Possible variations are listed in the technical specifications of the products. If you have chosen one of our products for your project, we suggest you request photos of the panels or a few square metres of sample before making your purchase.

"MAN'S BEST FRIEND ON EARTH IS THE TREE. WHEN WE USE THE TREE RESPECTFULLY AND ECONOMICALLY, WE HAVE ONE OF THE GREATEST RESOURCES ON THE EARTH"

Frank Lloyd Wright

A TENER EN CUENTA

Todos los materiales naturales son perfectamente imperfectos. La variación existente entre piezas hace que cada una de ellas sea única e irrepetible. Esta característica NO ES UN DEFECTO DEL MATERIAL sino una parte inherente de la belleza del producto.

Si somos capaces de trasladarle las características de nuestros productos estamos convencidos que cubriremos sus expectativas en cuanto a calidad y belleza. Por ello es muy importante que entienda que está comprando un producto natural cuyas características incluyen en algunos casos:

1.- Nudos rellenos de masilla

Las vetas y nudos de los parquet de madera natural son una de las principales características que hacen de cada lama un elemento único y que forma parte de la belleza del producto. Éstas se rellenan con una masilla de un color similar al tono de la madera o con masilla negra dependiendo del modelo. En nuestro catálogo encontrará información, tanto del tamaño de los nudos como de la cantidad que pueden aparecer.

2.- Variación de tonalidad

Todos los materiales naturales varían tanto en tono como en la propia estructura de la pieza. Desde L'Antic Colonial se realiza una exhaustiva clasificación mediante la que se eliminan los elementos que no superan nuestros estándares de calidad. En las fichas técnicas de nuestros productos se muestran las posibles variaciones de los mismos. Si ha seleccionado uno de nuestros materiales para su proyecto, le recomendamos que solicite imágenes de paneles o unos metros cuadrados de muestra antes de realizar la compra.

"EL MEJOR AMIGO DEL HOMBRE EN LA TIERRA ES EL ÁRBOL. USARLO CON RESPETO Y MODERACIÓN GARANTIZA UNO DE LOS MEJORES RECURSOS DEL PLANETA"

Frank Lloyd Wright

À NOTER

Tous les matériaux naturels sont parfaitement imparfaits. Les variations existant d'une pièce à l'autre les rendent uniques. Cette caractéristique NE CONSTITUE PAS UN DÉFAUT DU MATÉRIAU, elle fait partie intégrante de la beauté du produit.

Nous sommes convaincus que si nous réussissons à vous transmettre les caractéristiques de nos produits, nous répondrons à vos attentes en termes de qualité et de beauté. C'est la raison pour laquelle nous tenons à vous informer que vous achetez un produit naturel dont les particularités incluent parfois:

1.- Des noeuds remplis d'enduit

Les veines et les noeuds constituent l'une des principales caractéristiques des parquet en bois naturel; inhérents à la beauté du produit, ils donnent à chaque lame son caractère unique. Ces noeuds sont remplis d'un enduit noir ou d'une couleur similaire au ton du bois en fonction du modèle. Notre catalogue vous renseigne sur la taille des noeuds qui peuvent apparaître mais aussi sur leur quantité.

2.- Variations de tonalité

Tous les matériaux naturels varient à la fois au niveau du ton et de la structure même de la pièce. Chez L'Antic Colonial nous procédons à un classement exhaustif permettant d'éliminer les éléments qui ne répondent pas à nos standards de qualité. Les éventuelles variations de nos produits sont mentionnées sur leur fiche technique. Si vous avez sélectionné l'un de nos matériaux pour votre projet, nous vous recommandons de demander des images des panneaux ou quelques mètres carrés d'échantillon avant de réaliser votre achat.

"LE MEILLEUR AMI DE L'HOMME SUR TERRE EST L'ARBRE. L'UTILISER AVEC RESPECT ET PARCIMONIE C'EST S'ASSURER L'UNE DES MEILLEURES RESSOURCES DE LA PLANÈTE."

Frank Lloyd Wright

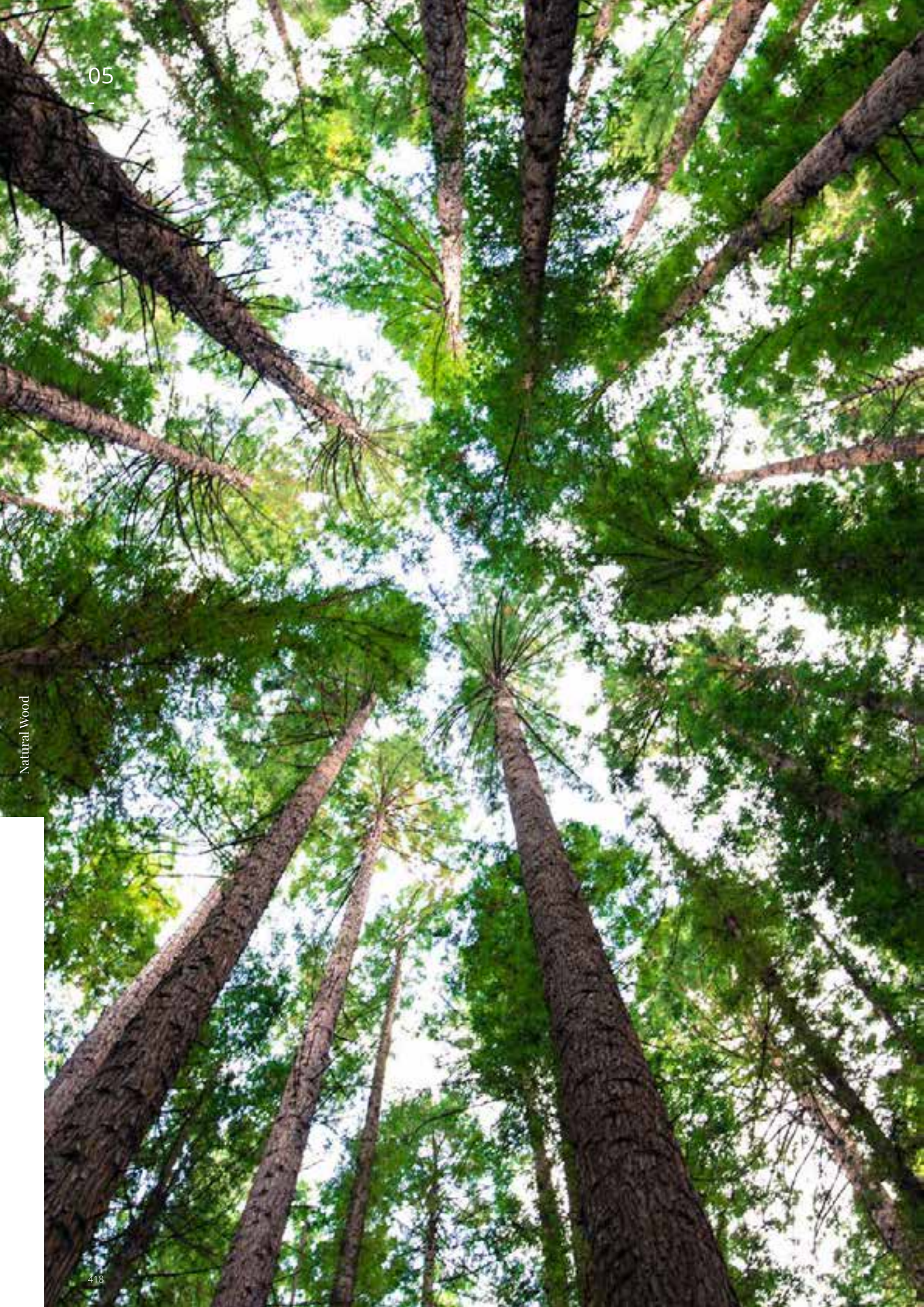

Environmental Commitment / Compromiso Medioambiental / Notre Engagement en Faveur de L'environnement

Natural wood floors are one of the most environmentally-friendly options available in the market. It is a renewable, sustainable product, the best choice for an "eco-house". Natural wood is one of the most plentiful natural resources. Sustainable forest management permits the use of this raw material without any environmental impact. At L'Antic Colonial we only use wood from sustainable forests. Controlled forest areas in which many more trees are grown than cut down. In this way, we are able to guarantee the constant creation of new green spaces while at the same time reducing the negative effect of carbon dioxide in the atmosphere.

In addition, the processes used to manufacture and install wood flooring consume far less energy than any other building material.

At present, the popularity of natural wood floors has increased significantly, resulting in higher consumption of the raw material. At the same time, the commitment to the environment of the companies producing this type of floor has been consolidated.

At L'Antic Colonial we have taken this commitment seriously right from the start. The environmental certificates held by our natural wood products are evidence of this:

"THE AVERAGE ANNUAL NET GROWTH FOR HARDWOODS FOR WOOD FLOORS IS GREATER THAN AVERAGE ANNUAL REMOVALS."

(Source: United States Department of Agriculture Forest Service).

"WOOD IS A CARBON NEUTRAL PRODUCT THAT PRODUCES OXYGEN DURING ITS GROWTH CYCLE AND STORES CARBON DURING ITS SERVICE LIFE."

(Source: University of Wisconsin Wood Products Program Solid wood flooring. Life Cycle Analysis).

"WOOD FLOORS LAST HUNDREDS OF YEARS, SO WON'T NEED TO BE REPLACED AS OFTEN AS OTHER FLOORING OPTIONS."

(Source: National Association of Home Builders USA).

Los suelos de madera natural son una de las opciones más respetuosas con el medio ambiente del mercado. Se trata de un producto renovable y sostenible que supone la mejor elección para una "vivienda verde". La madera natural es uno de los materiales más abundantes en la naturaleza. Una gestión forestal sostenible permite el uso de esta materia prima sin ningún impacto sobre el medio ambiente.

En L'Antic Colonial unicamente utilizamos madera proveniente de bosques sostenibles. Zonas forestales controladas en las que se cultivan muchos más árboles de los que se talan. De este modo aseguramos la creación constante de nuevos espacios verdes a la vez que reducimos el efecto negativo que el dióxido de carbono tiene en la atmósfera.

Además, el proceso de fabricación e instalación de pavimentos de madera consume mucha menos energía que cualquier otro material de construcción.

En la actualidad, la popularidad de los suelos de madera natural se ha incrementado considerablemente, lo que ha provocado el mayor consumo de esta materia prima. Paralelamente, también se ha consolidado el compromiso con el medio ambiente por parte de las empresas productoras de estos suelos.

En L'Antic Colonial tomamos ese compromiso desde el primer día. Así lo demuestran las certificaciones ambientales que poseen nuestros productos de madera natural:

"EL CRECIMIENTO MEDIO ANUAL NETO DE MADERAS DURAS PARA SUELOS DE MADERA ES MAYOR QUE EL PROMEDIO ANUAL DE EXTRACCIÓN."

(Fuente: Departamento de Agricultura del Servicio Forestal de Estados Unidos).

"LA MADERA ES UN PRODUCTO NEUTRO DE CARBONO QUE PRODUCE OXÍGENO DURANTE SU CICLO DE CRECIMIENTO Y ALMACENA CARBONO DURANTE SU SERVICIO DE VIDA."

(Fuente: Universidad de Wisconsin Wood Products Program Tarima de madera maciza. Análisis del Ciclo de Vida).

"LOS SUELOS DE MADERA EXISTEN DESDE HACE CIENTOS DE AÑOS, POR LO QUE NO TENDRÁN QUE SER REEMPLAZADOS CON LA FRECUENCIA QUE OTRAS OPCIONES DE SUELOS."

(Fuente: Asociación Nacional de Constructores de Viviendas EEUU).

Les sols en bois naturel constituent l'une des solutions les plus respectueuses de l'environnement disponibles sur le marché. Produit renouvelable et durable, c'est incontestablement le meilleur choix pour une «habitation verte».

Le bois naturel est l'un des matériaux les plus abondants dans la nature. Une gestion forestière durable permet d'utiliser cette matière première sans impacter l'environnement.

Chez L'Antic Colonial nous utilisons du bois provenant de forêts à gestion durable. Il s'agit de zones forestières contrôlées où le nombre d'arbres plantés dépasse le nombre d'arbres coupés. Cela permet de garantir le renouvellement constant des espaces verts tout en réduisant l'effet négatif du dioxyde de carbone sur l'atmosphère.

De plus, le processus de fabrication et de pose des revêtements en bois consomme beaucoup moins d'énergie que n'importe quel autre matériau de construction.

De nos jours, la consommation de cette matière première s'est considérablement accrue, portée par l'attrait pour les sols en bois naturel. Parallèlement, les entreprises productrices de ce type de planchers ont renforcé leur engagement en faveur de l'environnement.

Chez L'Antic Colonial, nous nous sommes engagés en ce sens dès le premier jour comme en témoignent les certifications en matière d'environnement que possèdent nos produits en bois naturel:

«LA CROISSANCE MOYENNE ANNUELLE NETTE DES BOIS DURS POUR SOLS EN BOIS EST SUPÉRIEURE À LA MOYENNE ANNUELLE RÉCOLTÉE.»

(Source: Département d'Agriculture du Service Forestier des États-Unis).

«LE BOIS EST CONSIDÉRÉ COMME UN PRODUIT NEUTRE EN CARBONE QUI PRODUIT DE L'OXYGÈNE DURANT SON CYCLE DE CROISSANCE ET STOCKE DU CARBONE PENDANT SA VIE UTILE.»

(Source: Université du Wisconsin, Wood Products Program, Analyse du cycle de vie des parquets en bois massif).

«LES PLANCHERS EN BOIS EXISTENT DEPUIS DES SIÈCLES, ILS NE NÉCESSITENT PAS D'ÊTRE REMPLACÉS À LA MÊME FRÉQUENCE QUE D'AUTRES TYPES DE SOLS.»

(Source: Association nationale des constructeurs d'habitations des États-Unis).



MODERN

Different colours, types of brushing and designs.

Diferentes colores, cepillados y diseños.

Couleurs, rabotages et designs variés.



CLASSIC

Classic designs manufactured using cutting-edge technologies.

Diseños clásicos fabricados con las tecnologías más vanguardistas.

Designs classiques fabriqués avec des technologies de pointe.



LEGACY

Oak parquet, bonded to a 100x100x2cm thick square base layer.

Madera de roble entrelazada, montada sobre un formato cuadrado de 100x100cm y 2cm de espesor.

Bois de chêne entrelacé, monté sur un format carré de 100x100cm d'une épaisseur de 2cm.



CHEVRON

Oak parquet in an inverted "V" pattern, bonded to a 56x51.5x1.6cm thick base layer.

Madera de roble dispuesta en "punta hungria" y montada sobre un formato de 56 x51.5cm y 1.6cm de espesor.

Bois de chêne disposé en « pointe de Hongrie » et monté sur un format de 56x51.5cm d'une épaisseur de 1.6cm.



TORTONA

Combination of fine wood with an intermediate layer of HDF.

Combinación de madera noble con una capa intermedia de HDF.

Combinaison de bois noble et d'une couche intermédiaire de HDF.



ARTISAN

Oak planks treated to give the worn appearance of a floor that has been walked upon by many generations.

Lamas de roble trabajadas hasta adquirir el aspecto desgastado de un suelo que ha sido habitado por muchas generaciones.

Lames en chêne travaillées pour obtenir l'aspect usé d'un sol en place depuis de nombreuses générations.



ADVANCE

Combination of fine wood with an intermediate layer of HDF and 220cm format.

Combinación de madera noble con capa intermedia de HDF y formato 220cm.

Lames intercalées les unes entre les autres de manière à donner un effet de contraste.



ADVANCE PREMIUM

Advance Evolution, with larger and thicker models (25 x 240 x 1.4 cm) and a 3 mm surface layer.

Evolución de Advance, con modelos de mayor formato y espesor (25 x 240 x 1,4cm) y una capa noble de 3 mm.

Évolution d'Advance, avec des modèles plus grands et plus épais (25x240x1,4 cm) et une couche noble de 3 mm.



DOWNTOWN

90 degree angle herringbone pattern 120 x 60 x 1.2 cm, which contains a 3 mm surface layer

Formato de espiga a 90 grados con un formato de 120 x 60 x 1,2cm, que contiene una capa noble de 3 mm.

Format en épi à 90 degrés, avec un format de 120x60x1,2 cm, qui comprend une couche noble de 3 mm.



NATURE

New oak wood 220 x 18 x 1.35cm in all its references except Toasted, which has a variation in width of 17.3cm.

Madera de roble limpio con un formato de 220 x 18 x 1,35cm en todas sus referencias excepto Toasted, la cual varía en el ancho a 17,3cm.

Bois de chêne propre avec un format de 220x18x1,35 cm dans toutes les références, exception faite de Toasted, dont la largeur est de 17,3 cm.

Collections / Colecciones / Collections



EDEN

A sensation of solid wood that can be installed as a floating floor, glued or nailed down.

Sensación de madera maciza con la opción de poder colocarse flotante, pegada o clavada.

Sensation du bois massif, possibilité de pose flottante, collée ou clouée.



MINI EDEN

Similar to the Eden collection but with more benefits for home improvements thanks to its reduced thickness.

Similar a la colección Eden pero con mayores ventajas para la renovación por su reducido espesor.

Similaire à la collection Eden, il présente plus d'avantages en termes de rénovation en raison de son épaisseur réduite.



EDEN TEXTURE

Eden with slight saw marks.

Eden con ligeras marcas de aserrado.

Eden présentant de légères marques de sciage.



MINI EDEN TEXTURE

Similar to the Eden Texture but with more benefits for home improvements thanks to its reduced thickness.

Como el Eden Texture pero con mayores ventajas para la renovación por su reducido espesor.

Similaire à la collection Eden Texture, il présente plus d'avantages en termes de rénovation en raison de son épaisseur réduite.



LEGEND

Large format board with the appearance of worn wood.

Ancho de lama de gran dimensión con aspecto de madera desgastada.

Lames larges de grandes dimensions, aspect du bois usé.



REVIVAL

Rustic wood, with cracks and knots that have been worked and filled with wood putty in a variety of tones.

Madera rústica, con grietas y nudos trabajados rellenos de masilla con diversas tonalidades.

Bois rustique aux fissures et noeuds travaillés remplis d'enduits de différentes teintes.



AUTHENTIC

24cm wide strips with a hand-brushed finish.

Gran ancho de lama (24cm) combinado con el acabado cepillado realizado a mano.

Une grande largeur de lame (24cm) associée à une finition brossée à la main.



WOOD LOVERS™

Oak with different formats, colours and textures that can be selected according to the customer's choice.

Roble con diferentes formatos, colores y texturas que puede seleccionarse según la elección del cliente.

Bois de chêne de différents formats, couleurs et textures sélectionné selon les préférences du client.



TREVILLE

Oak wood with a brushed finish and a small size of 13 x 109.2 x 1.4cm.

Madera de roble con un acabado cepillado y un pequeño formato de 13 x 109,2 x 1,4cm.

Bois de chêne avec une finition brossée et un petit format de 13x109,2x1,4 cm.

L'Antic Colonial's natural wood flooring is made up of different layers depending on the model.
 Los pavimentos de madera natural de L'Antic Colonial se componen de diferentes capas dependiendo del modelo.
 Les revêtements de sol en bois naturel de L'Antic Colonial se composent d'un nombre de couches différent variant selon le modèle.

GENERAL MULTI-LAYER STRUCTURE / MULTICAPA GENERAL / MULTICOUCHE GÉNÉRAL

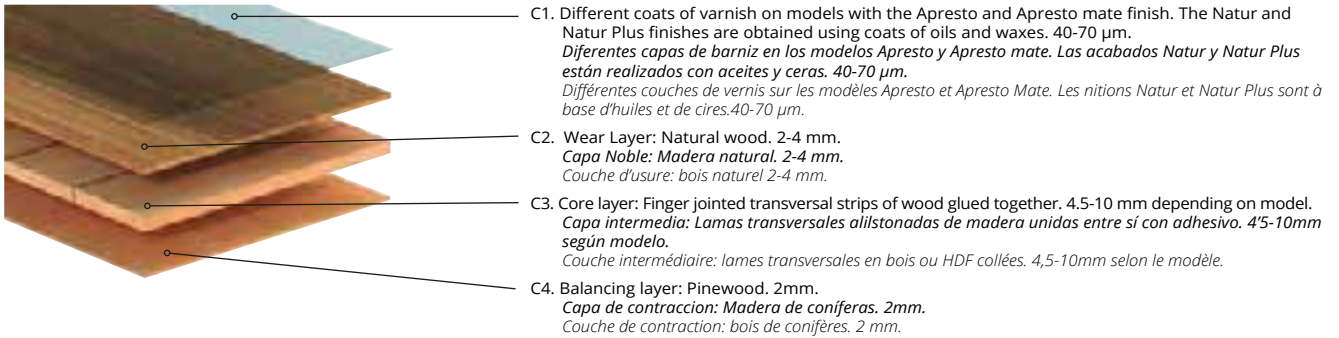

MULTI-LAYER HDF / MULTICAPA HDF / MULTICOUCHE HDF

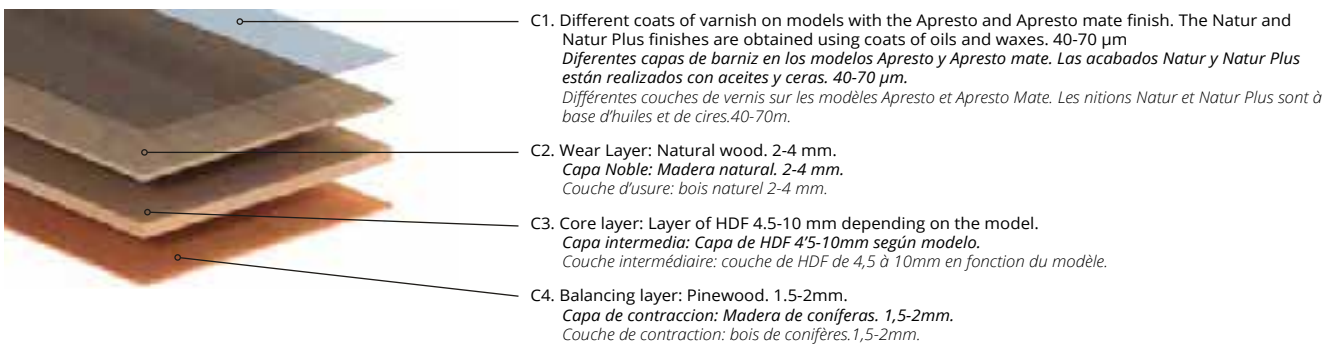

EDEN / MINI EDEN / REVIVAL

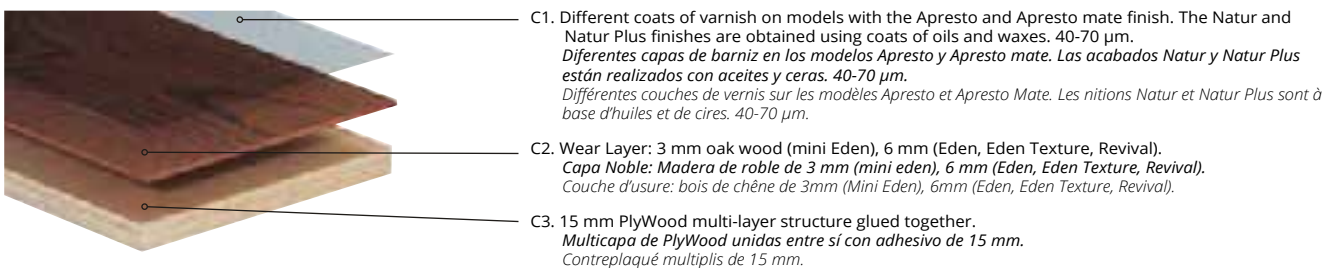

WOOD LOVERS™

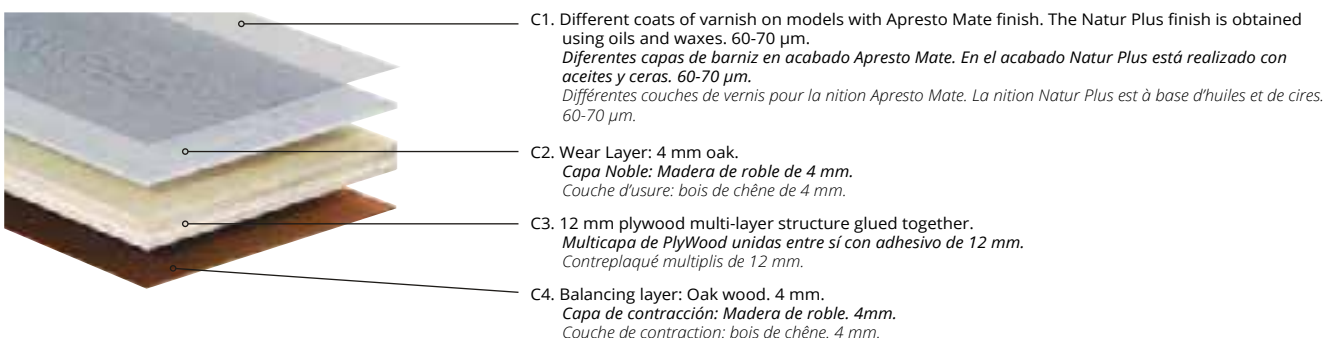

Installation Systems / Sistemas de Instalación / Systèmes de Pose

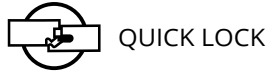

QUICK LOCK



1. Fit Together
Encajar
Emboîtement



2. Press Into Place
Presionar
Compression



3. Ready
Listo
Et Voilà

- Tool-free installation system. / *Montaje sin herramientas. / Montage sans outils.*
- Very quick to lay. / *Muy rápida instalación. / Installation très rapide.*
- Professional end results. / *Acabado profesional. / Finition professionnelle.*
- Easy to lay and just as easy to take up. / *Tan sencillo de instalar como de desinstalar. / Aussi simple à poser qu'à retirer.*
- Secure locking system on all four sides of the boards. / *Uniones seguras en los cuatro lados de las lamas. / Unions sûres sur les quatre côtés des lames.*
- Can be bonded to the floor. / *Se puede pegar al suelo. / Le produit peut être collé sur le sol.*

One of the easiest, most secure installation systems on the market. Just angle boards against the long side of the previously fitted one and press down gently. No tools are needed. The boards will lock into place and remain firmly secure, thanks to the tongue and groove system. The flooring is just as swift and easy to take up.

Es uno de los sistemas de más fácil instalación y seguro del mercado. Tan sólo se tiene que ajustar la lama que se va a instalar en sentido longitudinal a la ya colocada ejercer una suave presión sin ningún tipo de herramienta. Las dos piezas encajarán y quedarán sujetas gracias a la lengüeta de seguridad. Su desinstalación es igual de sencilla, lo que permite que sea desmontado rápidamente.

Système parmi les plus simples à poser et les plus sûrs du marché. Il suffit de positionner la lame à installer dans le sens de la longueur contre une lame déjà posée et d'exercer une légère pression sans aucun type d'outillage. Les deux pièces s'emboîtent et restent unies grâce à une languette de sécurité. Le démontage est tout aussi simple, ce qui permet un retrait rapide.



TRADITIONAL TONGUE & GROOVE / MACHICHEMRADO TRADICIONAL / SYSTÈME TRADITIONNEL À LANGUETTES ET RAINURES



1. Gluing
Encolar
Encollage



2. Fit Together
Encajar
Emboîtement



3. Press Into Place
Presionar
Compression



4. Ready
Listo
Et Voilà

An installation system where tongues and grooves along the edges of the boards are used to fit them together. A little pressure must be exerted to slot the boards into place and they are bonded with wood glue. Tools are needed to assemble them.

Sistema de instalación que consiste en ensamblar las lamas por medio de rebajes y cortes en sus cantos aplicando una pequeña presión en las tablas y fijándolo con una cola blanca. Para su disposición es necesario el uso de herramientas.

Ce système de pose consiste à assembler les lames au moyen d'évidements et de découpes pratiqués sur leurs bords en appliquant une légère pression sur les planches. Les lames sont ensuite fixées à l'aide d'une colle blanche. Des outils sont nécessaires pour la pose.



LOCK



1. Tip
Inclinar
Inclinaison



2. Fit Together
Encajar
Emboîtement



3. Press Into Place
Presionar
Compression

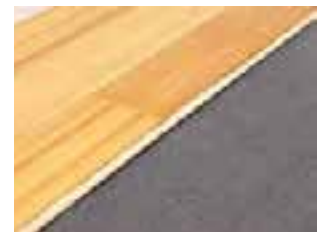

4. Ready
Listo
Et Voilà

One of the main features of this easy-to-install system is the long-lasting secure locking mechanism, ensuring that no gaps appear between the boards during the floor's useful life. Pressure is exerted on the boards when fitted, locking them securely into place and preventing them from being wrongly aligned.

La seguridad y la durabilidad de unión entre juntas son las principales características de este sistema de fácil instalación que garantiza la eliminación de las rendijas entre las lamas durante toda la vida útil del suelo. La presión que se ejerce entre las lamas refuerza la unión e impide que ésta no se realice de forma incorrecta.

La sécurité et la durabilité du raccord entre les planches constituent les principales caractéristiques de ce système facile à poser qui garantit l'élimination de fentes entre les planches tout au long de la vie utile du revêtement de sol. La pression exercée entre les planches renforce leur assemblage et empêche toute erreur de pose.

05 Description of Finishes / Descripción Acabados / Description Finitions



BRUSHED

Slight smoothing of the wood using a brush to achieve a surface with a slight relief.

CEPILLADO

Ligero desbastado de la madera utilizando un cepillo para conseguir así una superficie con ligero relieve.

BROSSAGE

Léger dégrossissage du bois avec une brosse pour obtenir un relief délicat sur la surface.



STRIPPING

Removal of the stain layer in some areas of the surface, creating a contrast between the stained and "washed" areas.

DECAPADO

Eliminación de la capa de tinte en algunas zonas de la superficie, creando un contraste entre las zonas tintadas y las zonas "lavadas".

DÉCAPAGE

Élimination de la couche de teinte dans certaines zones de la surface, ce qui crée un contraste entre les zones teintées et les zones « lavées ».



ARTISÁN

The finish imitates traditional hand brushing of the wood, providing a rough and artisan look.

Como hicieran los ebanistas de antaño, el acabado imita el tradicional cepillado a mano de la madera, proporcionando un aspecto rudo y artesano.

La finition imite le brossage traditionnel manuel du bois pour obtenir un aspect rustique et artisanal.



BEVEL 4

Beveled cut on all 4 edges of the board in order to emphasize its size.

BISEL 4

Corte oblicuo en los 4 bordes de las lamas para resaltar el tamaño.

BISEAU 4

Coupe oblique sur les 4 bords des lames pour mettre en valeur la dimension.

Description of Finishes / Descripción Acabados / Description Finitions



STAINED

Applying a color oil or varnish on the wood surface in order to get different color ranges.

TINTADO

Aplicación de un aceite o barniz de color sobre la superficie de la madera para obtener diferentes gamas cromáticas.

TEINTURE

Application d'une huile ou d'un vernis de couleur sur la surface du bois pour obtenir des tonalités différentes.



HEAT TREATED

Wood subjected to temperatures above 160°, thus altering its properties, and giving color to the entire wear layer section.

TERMOTRATADO

Madera sometida a temperaturas superiores a 160°, alterando de este modo sus propiedades y dando color a toda la sección de la capa noble.

TRAITEMENT THERMIQUE

Bois soumis à des températures supérieures à 160 °, afin d'altérer ses propriétés et de donner de la couleur à toute la section de couche noble.



BEVEL 2

Beveled cut on the long sides of the board in order to create a continuity effect.

BISEL 2

Corte oblicuo en los lados largos de las lamas para crear efecto de continuidad.

BISEAU 2

Coupe oblique sur la longueur des lames pour créer des effets de continuité.

05 Key to Symbols / Descripción de Iconos / Description des Symboles



NATUR

Combination of natural oils and waxes and air-drying leaving the wood with its pores open. This type of oil penetrates continuously into the wood, even when it has been laid, giving it a "dry" appearance when it is opened before laying. Benefits: Easy to repair scratches and knocks, natural look and simple maintenance with the right products. Just after laying and before using for the first time, we recommend using CLEAN&GREEN AQUA OIL 1 L.

Combinación de aceites y ceras de origen natural con secado al aire que dejan la madera con el poro abierto. Este tipo de aceite penetra continuamente en la madera, aun estando encajado, por lo que puede presentar un aspecto "seco" al abrirlo para ser colocado. Ventajas: Fácil reparación de golpes y rayas, aspecto muy natural y mantenimiento sencillo con los productos adecuados. Justo después de la instalación y antes del primer uso recomendamos la utilización de CLEAN&GREEN AQUA OIL 1L.

Combinaison d'huiles et cires d'origine naturelle séchées à l'air qui laisse les pores du bois ouverts. Ce type d'huile pénètre continuellement le bois, même lorsqu'il est emboîté, ce qui peut lui apporter un aspect «sec» lors de son ouverture. Avantages: Réparation simple de chocs et rayures, aspect très naturel et facile d'entretien avec les produits adéquats. Nous vous recommandons d'appliquer le produit CLEAN&GREEN AQUA OIL 1L juste après la pose et avant la première utilisation.



NATUR PLUS

Combination of oils and waxes designed to be dried with ultraviolet lamps. This finish allows the wood to keep the natural look produced using conventional oils but offers greater resistance to everyday stains and requires less maintenance. Benefits: Natural appearance, low maintenance and higher levels of resistance to water, wine, juice... stains. Just after laying and before using for the first time, we recommend using CLEAN&GREEN AQUA OIL 1 L.

Combinación de aceites y ceras preparadas para ser secadas con lámparas ultravioleta. Con este acabado, la madera conserva el aspecto natural del aceite convencional pero tiene mas resistencia a las manchas de productos de uso cotidiano y un menor mantenimiento. Ventajas: Aspecto muy natural, bajo mantenimiento y mayor resistencia a manchas de agua, vino, zumo... Justo después de la instalación y antes del primer uso recomendamos la utilización de CLEAN&GREEN AQUA OIL 1L.

Combinaison d'huiles et cires préparées pour être séchées avec des lampes à ultraviolets. Grâce à cette finition le bois conserve l'aspect naturel de l'huile traditionnelle mais est plus résistant aux tâches de produits d'usage quotidien et son entretien est réduit. Avantages: Aspect très naturel, faible entretien et meilleure résistance aux tâches d'eau, de vin, de jus, etc. Nous vous recommandons d'appliquer le produit CLEAN&GREEN AQUA OIL 1L juste après la pose et avant la première utilisation.

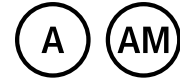

APRESTO / APRESTO MATE

L'ANTIC COLONIAL's APRESTO (satin) and APRESTO MATE (matt) varnish finishes guarantee a unique quality surface able to meet the most demanding of requirements. Benefits: Obtains the highest of hygiene standards, because the pores in the wood are sealed, dirt and dust remain on the surface and can be easily cleaned away.

El barnizado de L'ANTIC COLONIAL, en sus dos acabados, APRESTO (satinado) y APRESTO MATE, proporciona una calidad de superficie única, que satisface las mayores exigencias. Ventajas: Logra el nivel más alto de higiene, ya que al sellar los poros la suciedad y el polvo quedan en la superficie, pudiendo ser limpiados fácilmente.

Les finitions APRESTO (satiné) et APRESTO MATE du vernis de L'ANTIC COLONIAL créent une qualité de surface unique capable de satisfaire les plus grandes exigences. Avantages: Garantit le plus haut niveau d'hygiène car, les pores de la surface étant bouchés, les salissures et la poussière ne peuvent pas y pénétrer, ce qui facilite considérablement le nettoyage.



LOW NUMBER OF KNOTS

Parquet with few knots on its surface that can vary in size depending on the type of wood. These, along with any cracks that may appear, shall be covered with putty.

CANTIDAD NUDOS BAJA

Parquet con pocos nudos en su superficie que pueden variar de tamaño dependiendo del tipo de madera. Éstos, junto con posibles grietas que puedan aparecer, están estucados con masilla.

FAIBLE QUANTITÉ DE NŒUDS

Parquet dont la surface présente peu de nœuds, qui peuvent être de dimension variable en fonction du type de bois. Ceux-ci, tout comme les fissures qui peuvent éventuellement apparaître, sont stuqués avec du mastic.



AVERAGE NUMBER OF KNOTS

Parquet with several knots on its surface that can vary in size depending on the type of wood. These, along with any cracks that may appear, shall be covered with putty.

CANTIDAD NUDOS MEDIA

Parquet con varios nudos en su superficie que pueden variar de tamaño dependiendo del tipo de madera. Éstos, junto con posibles grietas que puedan aparecer, están estucados con masilla.

QUANTITÉ DE NŒUDS MOYENNE

Parquet dont la surface présente plusieurs nœuds, qui peuvent être de dimension variable en fonction du type de bois. Ceux-ci, tout comme les fissures qui peuvent éventuellement apparaître, sont stuqués avec du mastic.



HIGH NUMBER OF KNOTS

Parquet with many knots on its surface that can vary in size depending on the type of wood. These, along with any cracks that may appear, shall be covered with putty.

CANTIDAD NUDOS ALTA

Parquet con muchos nudos en su superficie que pueden variar de tamaño dependiendo del tipo de madera. Éstos, junto con posibles grietas que puedan aparecer, están estucados con masilla.

QUANTITÉ DE NŒUDS ÉLEVÉE

Parquet dont la surface présente beaucoup de nœuds, qui peuvent être de dimension variable en fonction du type de bois. Ceux-ci, tout comme les fissures qui peuvent éventuellement apparaître, sont stuqués avec du mastic.



MULTI-LAYER

Structure consisting of an upper layer that has the noble look of the material, an intermediate layer of coniferous wood that compensates the tensions between the different parts, and a bottom plywood that provides dimensional stability.

MULTICAPA

Estructura formada por una capa superior que muestra el aspecto noble del material, una capa intermedia de madera de conifera que compensa las tensiones entre las diferentes partes y un contrachapado inferior que aporta estabilidad dimensional.

MULTICOUCHE

Structure constituée d'une couche supérieure qui montre l'aspect noble du matériau, d'une couche intermédiaire de bois de conifère qui compense les tensions entre les différentes parties et d'un contre-plaqué inférieur qui apporte la stabilité dimensionnelle.



FLOATING INSTALLATION

Installation system in which it is not necessary to glue the boards to the floor, although it might be possible that they need to be glued among them, only in the models that so indicate it.

INSTALACIÓN FLOTANTE

Sistema de instalación en el que no es necesario encolar las tablas al suelo, aunque si es posible que se tengan que encolar entre ellas, solo en los modelos que así lo indique.

SYSTÈME FLOTTANT

Système d'installation où il n'est pas nécessaire de coller les planches au sol, même s'il peut être nécessaire de les coller entre elles, uniquement sur les modèles où cela est indiqué comme tel.



GLUING

Boards must be glued to the floor to achieve stability and consistency. It also improves the soundproofing, eliminating any resonance effect.

ENCOLADO

Los tablonos deben encolarse al suelo para conseguir estabilidad y consistencia. Además mejora la insonorización eliminando cualquier efecto de resonancia.

COLLAGE

Les planches doivent être collées au sol pour obtenir stabilité et consistance. Par ailleurs, il améliore l'insonorisation en éliminant tous les effets de résonance.

Key to Symbols / Descripción de Iconos / Description des Symboles



30 YEAR WARRANTY

Quality product made of selected raw materials, guaranteeing its full performance in residential use for 30 years as required by L' Antic Colonial.

GARANTÍA 30 AÑOS

Producto de calidad, elaborado con materias primas seleccionadas, garantizando su uso pleno en vivienda por 30 años conforme a lo prescrito por L' Antic Colonial.

GARANTIE 30 ANS

Produit de qualité élaboré avec des matières premières de choix, avec une garantie de 30 ans d'utilisation en logement, conformément aux prescriptions de L'Antic Colonial.



RADIANT WATER FLOOR HEATING

Parquet suitable for installation over radiant water floor heating, by gluing the material directly to the floor or in a floating installation.

CALEFACCIÓN RADIANTE POR AGUA

Parquet apto para la instalación sobre calefacción radiante por agua, encolando el material al suelo directamente o en instalación flotante.

PLANCHER CHAUFFANT À EAU

Parquet adapté à une installation sur un sol chauffant à eau, par collage direct du matériau au sol ou sur un système flottant.



1 BOARD

Wooden piece in which only one full hardwood layer board has been used to finish the entire base surface.

1 LAMA

Pieza de madera en la que se ha usado solo una tabla entera de capa noble para completar toda la superficie de la base.

1 LAME

Pièce de bois où n'a été utilisée qu'une planche entière de couche noble pour compléter la totalité de la surface.



BATTENED

Boards are nailed on wooden battens.

RASTRELADO

Los tablonos se clavan sobre rastreles de madera.

TASSEAUX

Les planches sont clouées sur des tasseaux en bois.



OAK WOOD

Parquet made with oak wood.

MADERA DE ROBLE

Parquet realizado con madera de roble.

BOIS DE CHÊNE

Parquet réalisé en bois de chêne.



WALNUT WOOD

Parquet made with walnut wood.

MADERA DE NOGAL

Parquet realizado con madera de nogal.

BOIS DE NOYER

Parquet réalisé en bois de noyer.



SLIGHT COLOR VARIATION

There are slight color changes between boards.

VARIACIÓN DE TONO LIGERA

Existen cambios de color suaves entre lamas.

LÉGÈRE VARIATION DE TONALITÉ

Il existe de légers changements de couleur entre les lames.



MODERATE COLOR VARIATION

There are consistent color changes between boards.

VARIACIÓN DE TONO MODERADA

Existen cambios de color regulares entre lamas.

VARIATION DE TONALITÉ MODÉRÉE

Il existe des changements de couleur réguliers entre les pièces.



STRONG COLOR VARIATION

There are noticeable color changes between boards.

VARIACIÓN DE TONO FUERTE

Existen cambios de color importantes entre lamas.

FORTE VARIATION DE TONALITÉ

Il existe d'importants changements de couleur entre les lames.



ORIGIN EUROPE

Material from a European country.

PROCEDENCIA EUROPA

Material procedente de algún país europeo.

PROVENANCE EUROPÉENNE

Matériau en provenance d'un pays européen.



ORIGIN NORTH AMERICA

Material from a North American country.

PROCEDENCIA AMÉRICA DEL NORTE

Material procedente de algún país norteamericano.

PROVENANCE NORD-AMÉRICAINNE

Matériau en provenance d'un pays d'Amérique du Nord.



HARDWOOD LAYER

It indicates the thickness of the hardwood layer.

CAPA NOBLE

Indica el espesor de la capa noble.

COUCHE NOBLE

Indique l'épaisseur de la couche noble.



Certificates / Certificados / Certificats



PEFC, a pan-European forestry certificate, was created in 1998 as a voluntary scheme for promoting and certifying sustainable forest management. The aims of the PEFC certification scheme are to promote the sustainable management of forests as an environmentally appropriate, socially beneficial, economically viable form of management; to enhance a positive image of forests and timber as a renewable raw material; and to guarantee the origin of products from sustainably managed forests for consumers.

La Certificación Forestal Paneuropea (PEFC) surge en 1998 como un sistema de promoción y certificación voluntaria de la gestión forestal sostenible. Los objetivos de Certificación Forestal PEFC consisten en promover una Gestión Forestal Sostenible de las masas forestales, por ser una gestión apropiada para el medio ambiente, socialmente beneficiosa y económicamente viable; fortalecer y mejorar la imagen positiva del bosque y de la madera como materia prima renovable, y garantizar a los consumidores la procedencia de los productos de masas gestionadas de forma sostenible.

Le Programme de Reconnaissance des Certifications Forestières (PEFC) naît en 1998 comme un système de promotion et de certification volontaire de la gestion forestière durable. Les objectifs de Certification Forestière PEFC consistent à promouvoir une gestion durable des forêts, considérée comme appropriée pour l'environnement, socialement bénéfique et économiquement viable ; le PEFC vise également à renforcer et à améliorer l'image positive de la forêt et du bois en tant que matière première renouvelable, et à garantir aux consommateurs la provenance des produits forestiers gérés de manière durable.



The FSC® is an independent, non-governmental, non-profit-making international organization created in 1993 in order to promote an environmentally responsible, socially beneficial, economically viable form of forestry management throughout woodlands worldwide. The FSC® certificate guarantees that forestry products have been harvested from rationally managed woodlands in accordance with FSC® principles and criteria. These define the minimum levels required for the proper management of forests worldwide.

El FSC® es una organización independiente, no gubernamental, internacional y sin ánimo de lucro creada en 1993, con el objetivo de promover una gestión forestal ambientalmente responsable, socialmente beneficiosa y económicamente viable en los bosques de todo el mundo. El certificado FSC® garantiza al consumidor que los productos forestales proceden de montes aprovechados de forma racional, de acuerdo a los Principios y Criterios del FSC®, los cuales definen los niveles mínimos de buena gestión para los bosques de todo el mundo.

Le FSC® est une organisation indépendante, non gouvernementale, internationale et à but non lucratif, créée en 1993 dans le but de promouvoir une gestion forestière responsable en matière d'environnement, socialement bénéfique et économiquement viable dans les forêts du monde entier. Le certificat FSC® garantit au consommateur que les produits forestiers sont issus de forêts mises à profit de manière rationnelle, conformément aux principes et critères du FSC®, qui définissent les niveaux minimum de bonne gestion pour les forêts de la planète.



National Wood Flooring Association (NWFA), is a non-profit trade association that represents all segments of the hardwood flooring industry: manufacturers, distributors, retailers and fitters. Founded in the USA, it currently has members throughout the whole world. The association's clear goal is to provide professionals from the sector with training and resources, thus allowing customers to benefit from long-lasting high-quality flooring.

National Wood Flooring Association (NWFA), es una asociación comercial sin ánimo de lucro que representa todos los sectores de la industria de los suelos de madera: fabricantes, distribuidores, detallistas e instaladores. Nace en EEUU pero actualmente aglutina asociados de todo el mundo, con el claro objetivo de proporcionar a los profesionales del sector un servicio de capacitación y los recursos para asegurar que los clientes adquieran suelos duraderos de alta calidad.

La National Wood Flooring Association (NWFA) est une association commerciale à but non lucratif qui représente tous les secteurs de l'industrie des revêtements de sol en bois: fabricants, distributeurs, détaillants et installateurs. Née au États-Unis, elle compte actuellement des membres du monde entier et a pour objectif d'offrir aux professionnels du secteur un service de formation et les ressources nécessaires pour garantir que le client final achète un revêtement de sol durable et de grande qualité.



AITIM is a private non-profit association made up of businesses from the wood industry. The association's common goal is technical product development and product quality certification.

AITIM, es una asociación privada sin ánimo de lucro formada por empresas que trabajan en el sector de la madera. El objetivo común es el desarrollo técnico de los productos y acreditar la calidad de los mismos.

AITIM, est une association privée à but non lucratif formée par des entreprises du secteur du bois. L'objectif commun est le développement technique des produits et de certifier leur qualité.



Chevron 56x50,3cm - 22"x20 1/4"



Luxor 39x39cm - 15 3/8"x15 3/8"

Natural Wood



Eden & Eden Texture 1L 20x240-210cm - 7 7/8"x94 1/2"-82 5/8"



Mini Eden 1L 19x240-210cm - 7 1/2"x94 1/2"-82 5/8" & **Mini Eden Texture 1L** 19x210cm - 7 1/2"x82 5/8"



Advance Premium 1L 25x240cm - 9 7/8"x94 1/2"



Legend 1L 26x220cm - 10 1/2"x86 5/8"



Authentic 1L 24x220cm - 9 1/2"x86 5/8"



Advance & Nature 1L 18x220cm - 7 1/8"x86 5/8"

Formats / Formatos / Formats



Revival 1L 22x220cm - 8 5/8"x86 5/8"



Artisan 1L 19x190cm - 7 1/2"x74 3/4"

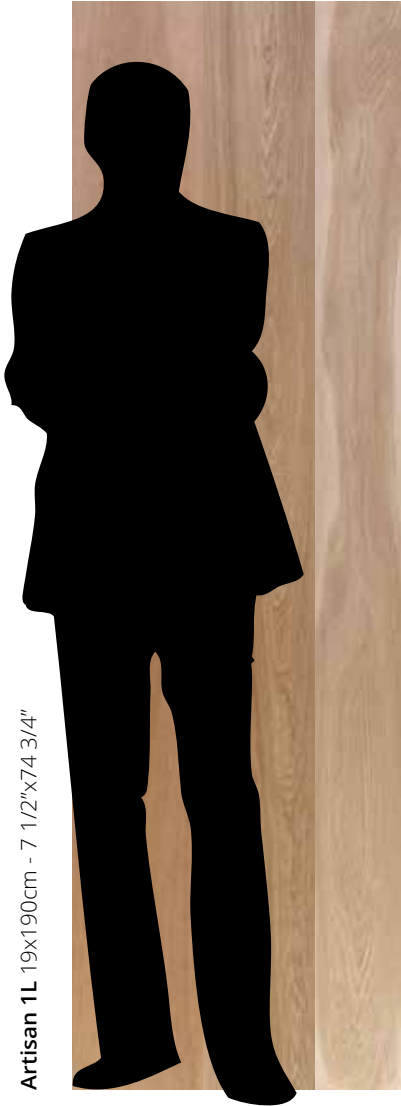

Multiformato 22x183cm - 5 7/8"x72", 18,9x183cm - 7 1/2"x72", 14,8x183cm - 5 7/8"x72"



Tortona 1L 14,5x120cm - 7 7/8"x94 1/2"



Treville 1L 13x109,2cm - 5 1/8"x43"



Downtown 12x60cm - 4 3/4"x23 5/8"



Espiga 7x49cm - 2 3/4"x19 1/4"



Legacy 100x100cm - 39 3/8"x39 3/8"



Modern

—
Multiformato Ceniza
Multiformato Natural
Multiformato Siena

Natural Wood



Modern
Multiformato Ceniza



Description	Format	Codes	Group	Pcs	m2	Kg
Modern Multiformato Ceniza	14,8/18,9/22x186x1,5cm 5 7/8"-7 1/2"-8 5/8"x73 1/4"x5/8"	100089195 L165002270	G-252	1 x Cj 21 x Pal	3,10 x Cj 65,27 x Pal	22,14 x Cj 465,045 x Pal
Skirting / Zócalo / Plinthe	8x220x1,4cm 3 1/8"x86 5/8"x9/16"	100079230 L168001511	G-128	12 x Cj 600 x Pal	2,11 x Cj 105,60 x Pal	16,56 x Cj 828 x Pal
Transition Profile / Perfil Transición / Profilé Jointoiment	4x270x1,3cm 1 5/8"x106 1/4"x1/2"	100083461 L164531491	G-161	10 x Cj 1000 x Pal	1,08 x Cj 108 x Pal	10,20 x Cj 1020 x Pal
Levelling Profile / Perfil Igualación / Profilé Égalisation	4,5x270x1,3cm 1 3/4"x106 1/4"x1/2"	100083463 L164531501	G-161	10 x Cj 1000 x Pal	1,08 x Cj 108 x Pal	10,20 x Cj 1020 x Pal
Stair Nosing / Mampierlan / Nez de Marche	120x7x3cm 47 1/4"x2 3/4"x1 1/8"	100176717 L165003715	G-163	2 x Cj 200 x Pal	0,17 x Cj 16,80 x Pal	3,28 x Cj 327,80 x Pal

MULTI-FORMAT
The boxes contain 3 boards
18,9x183x1,5cm, 3 boards 22x183x1,5cm
and 3 boards 14,8x183x1,5cm.

MULTIFORMATO
Las cajas contienen 3 lamas de
18,9x183x1,5cm, 3 lamas de 22x183x1,5cm
y 3 lamas de 14,8x183x1,5cm.

MULTIFORMAT
Chaque caisse contient 3 lames de
18,9x183x1,5cm, 3 lames de 22x183x1,5cm,
et 3 lames de 14,8x183x1,5cm.

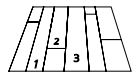

WIDE ANCHOS LARGEUR

- 1. 18,9cm | 7 1/2"
- 2. 22cm | 8 5/8"
- 3. 14,8cm | 5 7/8"

Due to better usage of the wood, any order of this reference may contain mean percentage tables of between 15% y 20% / Por un mejor aprovechamiento de la madera, cualquier pedido de esta referencia puede contener un porcentaje de medias tablas de entre 15% y 20% / Pour mieux mettre à profit le bois, toute commande portant sur cette référence peut contenir un pourcentage de demi-planches de 15% y 20%.

Natural Wood



Modern
Multiformato Natural

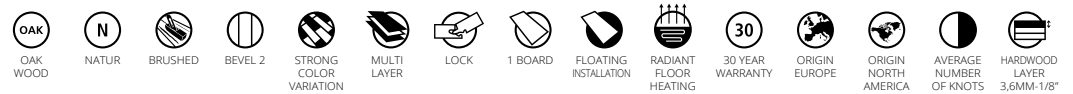

Description	Format	Codes	Group	Pcs	m2	Kg
Modern Multiformato Natural	14,8/18,9/22x186x1,5cm 5 7/8"-7 1/2"-8 5/8"x73 1/4"x5/8"	100089196 L165002271	G-252	1 x Cj 21 x Pal	3,11 x Cj 65,27 x Pal	28,50 x Cj 598,50 x Pal
Skirting / Zócalo / Plinthe	8x220x1,4cm 3 1/8"x86 5/8"x9/16"	100079227 L168001531	G-128	12 x Cj 600 x Pal	2,11 x Cj 105,60 x Pal	16,56 x Cj 828 x Pal
Transition Profile / Perfil Transición / Profilé Jointoiment	4x270x1,3cm 1 5/8"x106 1/4"x1/2"	100001949 L164511001	G-161	10 x Cj 1000 x Pal	1,08 x Cj 108 x Pal	10,20 x Cj 1020 x Pal
Levelling Profile / Perfil Igualación / Profilé Égalisation	4,5x270x1,3cm 1 3/4"x106 1/4"x1/2"	100001982 L164701001	G-161	10 x Cj 1000 x Pal	1,08 x Cj 108 x Pal	10,20 x Cj 1020 x Pal
Stair Nosing / Mampierlan / Nez de Marche	120x7x3cm 47 1/4"x2 3/4"x1 1/8"	100176718 L165003720	G-163	2 x Cj 200 x Pal	0,17 x Cj 16,80 x Pal	3,28 x Cj 327,80 x Pal

MULTI-FORMAT
The boxes contain 3 boards
18,9x183x1,5cm, 3 boards 22x183x1,5cm
and 3 boards 14,8x183x1,5cm.

MULTIFORMATO
Las cajas contienen 3 lamas de
18,9x183x1,5cm, 3 lamas de 22x183x1,5cm
y 3 lamas de 14,8x183x1,5cm.

MULTIFORMAT
Chaque caisse contient 3 lames de
18,9x183x1,5cm, 3 lames de 22x183x1,5cm,
et 3 lames de 14,8x183x1,5cm.

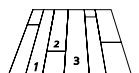

WIDE ANCHOS LARGEUR

- 1. 18,9cm | 7 1/2"
- 2. 22cm | 8 5/8"
- 3. 14,8cm | 5 7/8"

Due to better usage of the wood, any order of this reference may contain mean percentage tables of between 15% y 20% / Por un mejor aprovechamiento de la madera, cualquier pedido de esta referencia puede contener un porcentaje de medias tablas de entre 15% y 20% / Pour mieux mettre à profit le bois, toute commande portant sur cette référence peut contenir un pourcentage de demi-planches de 15% y 20%.

Modern



Modern Multiformato Siena



Description	Format	Codes	Group	Pcs	m2	Kg
Modern Multiformato Siena	14,8/18,9/22x186x1,5cm 5 7/8"-7 1/2"-8 5/8"x73 1/4"x5/8"	100088583 L165002262	G-252	1 x Cj 21 x Pal	3,11 x Cj 65,27 x Pal	22,14 x Cj 465,04 x Pal
Skirting / Zócalo / Plinthe	8x220x1,4cm 3 1/8"x86 5/8"x9/16"	100079228 L168001581	G-128	12 x Cj 600 x Pal	2,11 x Cj 105,60 x Pal	16,56 x Cj 828 x Pal
Transition Profile / Perfil Transición / Profilé Jointolement	4x270x1,3cm 1 5/8"x106 1/4"x1/2"	100083453 L164531471	G-161	10 x Cj 1000 x Pal	1,08 x Cj 108 x Pal	10,20 x Cj 1020 x Pal
Levelling Profile / Perfil Igualación / Profilé Égalisation	4,5x270x1,3cm 1 3/4"x106 1/4"x1/2"	100083458 L164531481	G-161	10 x Cj 1000 x Pal	1,08 x Cj 108 x Pal	10,20 x Cj 1020 x Pal
Stair Nosing / Mampelran / Nez de Marche	120x7x3cm 47 1/4"x2 3/4"x1 1/8"	100176742 L165003718	G-163	2 x Cj 200 x Pal	0,17 x Cj 16,80 x Pal	3,28 x Cj 327,80 x Pal

MULTI-FORMAT
The boxes contain 3 boards
18,9x183x1,5cm, 3 boards 22x183x1,5cm
and 3 boards 14,8x183x1,5cm.

MULTIFORMATO
Las cajas contienen 3 lamas de
18,9x183x1,5cm, 3 lamas de 22x183x1,5cm
y 3 lamas de 14,8x183x1,5cm.

MULTIFORMAT
Chaque caisse contient 3 lames de
18,9x183x1,5cm, 3 lames de 22x183x1,5cm,
et 3 lames de 14,8x183x1,5cm.

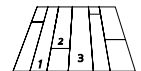

WIDE ANCHOS LARGUEUR

1. 18,9cm | 7 1/2"
2. 22cm | 8 5/8"
3. 14,8cm | 5 7/8"

Due to better usage of the wood, any order of this reference may contain mean percentage tables of between 15% y 20% / Por un mejor aprovechamiento de la madera, cualquier pedido de esta referencia puede contener un porcentaje de medias tablas de entre 15% y 20% / Pour mieux mettre à profit le bois, toute commande portant sur cette référence peut contenir un pourcentage de demi-planches de 15% y 20%.



Floor Coverings Modern Multiformato Ceniza

Classic

—
Espiga Yute
Espiga Nature
Ebano Luxor

Natural Wood





Classic Espiga Yute



Description	Format	Codes	Group	Pcs	m2	Kg
Classic Espiga Yute	7x49x1cm	100113073	G-249	72 x Cj	2,47 x Cj	13,61 x Cj
	2 3/4"x19 1/4"x3/8"	L165002503		2160 x Pal	74,09 x Pal	408,24 x Pal
Skirting / Zócalo / Plinthe	8x220x1,4cm	100190469	G-128	12 x Cj	2,11 x Cj	16,56 x Cj
	3 1/8"x86 5/8"x9/16"	L165003862		600 x Pal	105,60 x Pal	828 x Pal
Transition Profile / Perfil Transición / Profilé Jointoiment	4x270x1,3cm	100112657	G-161	10 x Cj	1,08 x Cj	10,20 x Cj
	1 5/8"x106 1/4"x1/2"	L165002410		1000 x Pal	108 x Pal	1020 x Pal
Levelling Profile / Perfil Igualación / Profilé Égalisation	4,5x270x1,3cm	100112653	G-161	10 x Cj	1,08 x Cj	10,20 x Cj
	1 3/4"x106 1/4"x1/2"	L165002397		1000 x Pal	108 x Pal	1020 x Pal
Stair Nosing / Mampierlan / Nez de Marche	120x7x3cm	100176559	G-163	2 x Cj	0,17 x Cj	3,28 x Cj
	47 1/4"x2 3/4"x1 1/8"	L165003713		200 x Pal	16,80 x Pal	327,80 x Pal

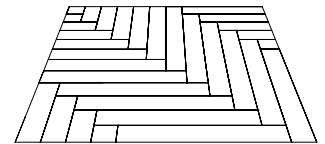

Instructions for laying / ejemplo de colocación / exemple de pose

Natural Wood



Classic Espiga Natura



Description	Format	Codes	Group	Pcs	m2	Kg
Classic Espiga Natura	7x49x1cm	100113072	G-238	72 x Cj	2,47 x Cj	13,61 x Cj
	2 3/4"x19 1/4"x3/8"	L165002504		2160 x Pal	74,09 x Pal	408,24 x Pal
Skirting / Zócalo / Plinthe	8x220x1,5cm	100112716	G-128	12 x Cj	2,11 x Cj	16,56 x Cj
	3 1/8"x86 5/8"x5/8"	L165002447		600 x Pal	105,60 x Pal	828 x Pal
Transition Profile / Perfil Transición / Profilé Jointoiment	4x270x1,3cm	100112656	G-161	10 x Cj	1,08 x Cj	10,20 x Cj
	1 5/8"x106 1/4"x1/2"	L165002430		1000 x Pal	108 x Pal	1020 x Pal
Levelling Profile / Perfil Igualación / Profilé Égalisation	4,5x270x1,3cm	100112652	G-161	10 x Cj	1,08 x Cj	10,20 x Cj
	1 3/4"x106 1/4"x1/2"	L165002416		1000 x Pal	108 x Pal	1020 x Pal
Stair Nosing / Mampierlan / Nez de Marche	120x7x3cm	100176543	G-163	2 x Cj	0,17 x Cj	3,28 x Cj
	47 1/4"x2 3/4"x1 1/8"	L165003717		200 x Pal	16,80 x Pal	327,80 x Pal

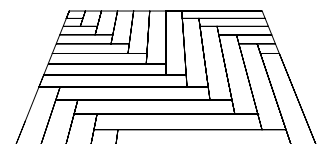

Instructions for laying / ejemplo de colocación / exemple de pose

Classic



Classic Ebano Luxor



Description	Format	Codes	Group	Pcs	m2	Kg
Classic Ebano Luxor	39x39x1,4cm	100003683	G-283	8 x Cj	1,22 x Cj	11,82 x Cj
	15 3/8"x15 3/8"x1/2"	L160701031		384 x Pal	58,41 x Pal	567,17 x Pal
Skirting / Zócalo / Plinthe	8x220x1,4cm	100112650	G-128	12 x Cj	2,11 x Cj	16,56 x Cj
	3 1/8"x86 5/8"x9/16"	L165002402		600 x Pal	105,60 x Pal	828 x Pal
Transition Profile / Perfil Transición / Profilé Jointoiment	4x270x1,3cm	100112648	G-168	10 x Cj	1,08 x Cj	10,20 x Cj
	1 5/8"x106 1/4"x1/2"	L165002431		1000 x Pal	108 x Pal	1020 x Pal
Levelling Profile / Perfil Igualación / Profilé Egalisation	4,5x270x1,3cm	100112641	G-161	10 x Cj	1,08 x Cj	10,20 x Cj
	1 3/4"x106 1/4"x1/2"	L165002442		1000 x Pal	108 x Pal	1020 x Pal
Stair Nosing / Mampelran / Nez de Marche	120x7x3cm	100176566	G-163	2 x Cj	0,17 x Cj	3,28 x Cj
	47 1/4"x2 3/4"x1 1/8"	L165003712		200 x Pal	16,80 x Pal	327,80 x Pal

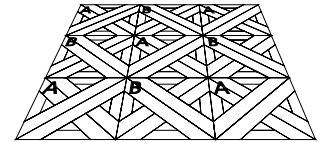

Instructions for laying / ejemplo de colocación / exemple de pose



Floor Coverings Classic Espiga Natura

Legacy

—
Vulcano
Tobacco
Cognac
Ceniza

Natural Wood



Legacy
Vulcano



Description	Format	Codes	Group	Pcs	m2	Kg
Legacy Vulcano	100x100x2cm 39 3/8"x39 3/8"x3/4"	100161673 L165003418	G-285	2 x Cj 80 x Pal	2 x Cj 80 x Pal	35,48 x Cj 1419,36 x Pal

*The Legacy and Chevron collections feature a tongue and groove installation system, with a groove on the four sides and loose strips to be laid as required, therefore eliminating problems in respect of the order.
 Las colecciones Legacy y Chevron, realizadas con el sistema de instalación machembrado, se sirven con hembra en los 4 costados y unos listones sueltos para colocarlos donde se necesite. De este modo se evitan problemas en el orden de las piezas.

Dotées du système d'installation à rainures et languettes, les collections Legacy et Chevron sont fournies avec des rainures sur les 4 côtés et des lattes séparées pour pouvoir les placer à l'endroit souhaité. Cela permet d'éviter les problèmes d'ordre des pièces.



Legacy
Tobacco



Description	Format	Codes	Group	Pcs	m2	Kg
Legacy Tobacco	100x100x2cm 39 3/8"x39 3/8"x3/4"	100161649 L165003417	G-285	2 x Cj 80 x Pal	2 x Cj 80 x Pal	35,48 x Cj 1419,36 x Pal

*The Legacy and Chevron collections feature a tongue and groove installation system, with a groove on the four sides and loose strips to be laid as required, therefore eliminating problems in respect of the order.
 Las colecciones Legacy y Chevron, realizadas con el sistema de instalación machembrado, se sirven con hembra en los 4 costados y unos listones sueltos para colocarlos donde se necesite. De este modo se evitan problemas en el orden de las piezas.

Dotées du système d'installation à rainures et languettes, les collections Legacy et Chevron sont fournies avec des rainures sur les 4 côtés et des lattes séparées pour pouvoir les placer à l'endroit souhaité. Cela permet d'éviter les problèmes d'ordre des pièces.

Legacy



Legacy Cognac



Description	Format	Codes	Group	Pcs	m2	Kg
Legacy Cognac	100x100x2cm 39 3/8"x39 3/8"x3/4"	100161666 L165003416	G-285	2 x Cj 80 x Pal	2 x Cj 80 x Pal	35,48 x Cj 1419,36 x Pal

*The Legacy and Chevron collections feature a tongue and groove installation system, with a groove on the four sides and loose strips to be laid as required, therefore eliminating problems in respect of the order.
 Las colecciones Legacy y Chevron, realizadas con el sistema de instalación machembrado, se sirven con hembra en los 4 costados y unos listones sueltos para colocarlos donde se necesite. De este modo se evitan problemas en el orden de las piezas.

Dotées du système d'installation à rainures et languettes, les collections Legacy et Chevron sont fournies avec des rainures sur les 4 côtés et des lattes séparées pour pouvoir les placer à l'endroit souhaité. Cela permet d'éviter les problèmes d'ordre des pièces.



Legacy Ceniza



Description	Format	Codes	Group	Pcs	m2	Kg
Legacy Ceniza	100x100x2cm 39 3/8"x39 3/8"x3/4"	100161665 L165003415	G-285	2 x Cj 80 x Pal	2 x Cj 80 x Pal	35,48 x Cj 1419,36 x Pal

*The Legacy and Chevron collections feature a tongue and groove installation system, with a groove on the four sides and loose strips to be laid as required, therefore eliminating problems in respect of the order.
 Las colecciones Legacy y Chevron, realizadas con el sistema de instalación machembrado, se sirven con hembra en los 4 costados y unos listones sueltos para colocarlos donde se necesite. De este modo se evitan problemas en el orden de las piezas.

Dotées du système d'installation à rainures et languettes, les collections Legacy et Chevron sont fournies avec des rainures sur les 4 côtés et des lattes séparées pour pouvoir les placer à l'endroit souhaité. Cela permet d'éviter les problèmes d'ordre des pièces.

Chevron

-
- Vulcano
 - Tobacco
 - Cognac
 - Ceniza





**Chevron
Vulcano**



Description	Format	Codes	Group	Pcs	m2	Kg
Chevron Vulcano	56x50,3x1,6cm 22"x20 1/4"x5/8"	100161648 L165003414	G-280	6 x Cj 144 x Pal	1,69 x Cj 15,21 x Pal	24,55 x Cj 221,02 x Pal

*The Legacy and Chevron collections feature a tongue and groove installation system, with a groove on the four sides and loose strips to be laid as required, therefore eliminating problems in respect of the order.

Las colecciones Legacy y Chevron, realizadas con el sistema de instalación machembrado, se sirven con hembra en los 4 costados y unos listones sueltos para colocarlos donde se necesite. De este modo se evitan problemas en el orden de las piezas.

Dotées du système d'installation à rainures et languettes, les collections Legacy et Chevron sont fournies avec des rainures sur les 4 côtés et des lattes séparées pour pouvoir les placer à l'endroit souhaité. Cela permet d'éviter les problèmes d'ordre des pièces.

Natural Wood



**Chevron
Tobacco**



Description	Format	Codes	Group	Pcs	m2	Kg
Chevron Tobacco	56x50,3x1,6cm 22"x20 1/4"x5/8"	100161672 L165003413	G-280	6 x Cj 144 x Pal	1,69 x Cj 15,21 x Pal	24,55 x Cj 221,02 x Pal

*The Legacy and Chevron collections feature a tongue and groove installation system, with a groove on the four sides and loose strips to be laid as required, therefore eliminating problems in respect of the order.

Las colecciones Legacy y Chevron, realizadas con el sistema de instalación machembrado, se sirven con hembra en los 4 costados y unos listones sueltos para colocarlos donde se necesite. De este modo se evitan problemas en el orden de las piezas.

Dotées du système d'installation à rainures et languettes, les collections Legacy et Chevron sont fournies avec des rainures sur les 4 côtés et des lattes séparées pour pouvoir les placer à l'endroit souhaité. Cela permet d'éviter les problèmes d'ordre des pièces.

Chevron



Chevron Cognac



Description	Format	Codes	Group	Pcs	m2	Kg
Chevron Cognac	56x50,3x1,6cm 22"x20 1/4"x5/8"	100161664 L165003412	G-280	6 x Cj 144 x Pal	1,69 x Cj 15,21 x Pal	24,55 x Cj 221,02 x Pal

*The Legacy and Chevron collections feature a tongue and groove installation system, with a groove on the four sides and loose strips to be laid as required, therefore eliminating problems in respect of the order.

Las colecciones Legacy y Chevron, realizadas con el sistema de instalación machembrado, se sirven con hembra en los 4 costados y unos listones sueltos para colocarlos donde se necesite. De este modo se evitan problemas en el orden de las piezas.

Dotées du système d'installation à rainures et languettes, les collections Legacy et Chevron sont fournies avec des rainures sur les 4 côtés et des lattes séparées pour pouvoir les placer à l'endroit souhaité. Cela permet d'éviter les problèmes d'ordre des pièces.



Chevron Ceniza



Description	Format	Codes	Group	Pcs	m2	Kg
Chevron Ceniza	56x50,3x1,6cm 22"x20 1/4"x5/8"	100161663 L165003411	G-280	6 X Cj 144 X Pal	1,69 X Cj 15,21 X Pal	24,55 X Cj 221,02 X Pal

*The Legacy and Chevron collections feature a tongue and groove installation system, with a groove on the four sides and loose strips to be laid as required, therefore eliminating problems in respect of the order.

Las colecciones Legacy y Chevron, realizadas con el sistema de instalación machembrado, se sirven con hembra en los 4 costados y unos listones sueltos para colocarlos donde se necesite. De este modo se evitan problemas en el orden de las piezas.

Dotées du système d'installation à rainures et languettes, les collections Legacy et Chevron sont fournies avec des rainures sur les 4 côtés et des lattes séparées pour pouvoir les placer à l'endroit souhaité. Cela permet d'éviter les problèmes d'ordre des pièces.





Downtown

—
Black Amber
Grey Payne
Clear
Neutral

Natural Wood



Downtown
Black Amber



Description	Format	Codes	Group	Pcs	m2	Kg
Downtown Black Amber	12x60x1,2cm 4 3/4"x23 5/8"x1/2"	100213748 L165004059	G-267	6 x Cj 864 x Pal	0,43 x Cj 62,21 x Pal	4,59 x Cj 661,82 x Pal
Skirting / Zócalo / Plinthe	8x220x1,4cm 3 1/8"x86 5/8"x9/16"	100214431 L165004108	G-128	12 x Cj 600 x Pal	2,11 x Cj 105,60 x Pal	16,56 x Cj 828 x Pal
Transition Profile / Perfil Transición / Profilé jointoiment	4x270x1,3cm 1 5/8"x106 1/4"x1/2"	100214387 L165004087	G-161	10 x Cj 1000 x Pal	1,08 x Cj 108 x Pal	10,20 x Cj 1020 x Pal
Levelling Profile / Perfil Igualación / Profilé Égalisation	4,5x270x1,3cm 1 3/4"x106 1/4"x1/2"	100214348 L165004095	G-161	10 x Cj 1000 x Pal	1,08 x Cj 108 x Pal	10,20 x Cj 1020 x Pal
Stair Nosing / Mampelran / Nez de Marche	120x7x3cm 47 1/4"x2 3/4"x1 1/8"	100214386 L165004096	G-163	2 x Cj 200 x Pal	0,17 x Cj 16,80 x Pal	3,28 x Cj 327,80 x Pal

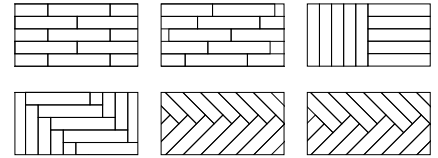

SUGGESTED LAYOUT / EJEMPLO COLOCACIÓN / EXEMPLE DE POSE

Natural Wood



Downtown
Grey Payne



Description	Format	Codes	Group	Pcs	m2	Kg
Downtown Grey Payne	12x60x1,2cm 4 3/4"x23 5/8"x1/2"	100213800 L165004055	G-267	6 x Cj 864 x Pal	0,43 x Cj 62,21 x Pal	4,59 x Cj 661,82 x Pal
Skirting / Zócalo / Plinthe	8x220x1,4cm 3 1/8"x86 5/8"x9/16"	100214409 L165004125	G-128	12 x Cj 600 x Pal	2,11 x Cj 105,60 x Pal	16,56 x Cj 828 x Pal
Transition Profile / Perfil Transición / Profilé jointoiment	4x270x1,3cm 1 5/8"x106 1/4"x1/2"	100214417 L165004085	G-161	10 x Cj 1000 x Pal	1,08 x Cj 108 x Pal	10,20 x Cj 1020 x Pal
Levelling Profile / Perfil Igualación / Profilé Égalisation	4,5x270x1,3cm 1 3/4"x106 1/4"x1/2"	100214385 L165004111	G-161	10 x Cj 1000 x Pal	1,08 x Cj 108 x Pal	10,20 x Cj 1020 x Pal
Stair Nosing / Mampelran / Nez de Marche	120x7x3cm 47 1/4"x2 3/4"x1 1/8"	100214420 L165004114	G-163	2 x Cj 200 x Pal	0,17 x Cj 16,80 x Pal	3,28 x Cj 327,80 x Pal

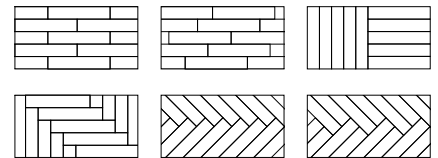

SUGGESTED LAYOUT / EJEMPLO COLOCACIÓN / EXEMPLE DE POSE

Downtown



Downtown Clear



Description	Format	Codes	Group	Pcs	m2	Kg
Downtown Black Clear	12x60x1,2cm 4 3/4"x23 5/8"x1/2"	100213759 L165004054	G-267	6 x Cj 864 x Pal	0,43 x Cj 62,21 x Pal	4,59 x Cj 661,82 x Pal
Skirting / Zócalo / Plinthe	8x220x1,4cm 3 1/8"x86 5/8"x9/16"	100214389 L165004115	G-128	12 x Cj 600 x Pal	2,11 x Cj 105,60 x Pal	16,56 x Cj 828 x Pal
Transition Profile / Perfil Transición / Profilé Jointoiment	4x270x1,3cm 1 5/8"x106 1/4"x1/2"	100214405 L165004109	G-161	10 x Cj 1000 x Pal	1,08 x Cj 108 x Pal	10,20 x Cj 1020 x Pal
Levelling Profile / Perfil Igualación / Profilé Egalisation	4,5x270x1,3cm 1 3/4"x106 1/4"x1/2"	100214368 L165004130	G-161	10 x Cj 1000 x Pal	1,08 x Cj 108 x Pal	10,20 x Cj 1020 x Pal
Stair Nosing / Mampelran / Nez de Marche	120x7x3cm 47 1/4"x2 3/4"x1 1/8"	100214395 L165004135	G-163	2 x Cj 200 x Pal	0,17 x Cj 16,80 x Pal	3,28 x Cj 327,80 x Pal

NEW

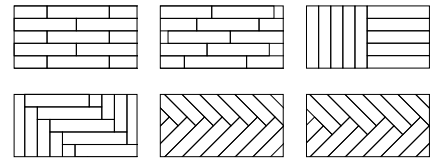

SUGGESTED LAYOUT / EJEMPLO COLOCACIÓN / EXEMPLE DE POSE



Downtown Neutral



Description	Format	Codes	Group	Pcs	m2	Kg
Downtown Neutral	12x60x1,2cm 4 3/4"x23 5/8"x1/2"	100213794 L165004061	G-267	6 x Cj 864 x Pal	0,43 x Cj 62,21 x Pal	4,59 x Cj 661,82 x Pal
Skirting / Zócalo / Plinthe	8x220x1,4cm 3 1/8"x86 5/8"x9/16"	100214432 L165004104	G-128	12 x Cj 600 x Pal	2,11 x Cj 105,60 x Pal	16,56 x Cj 828 x Pal
Transition Profile / Perfil Transición / Profilé Jointoiment	4x270x1,3cm 1 5/8"x106 1/4"x1/2"	100214421 L165004129	G-161	10 x Cj 1000 x Pal	1,08 x Cj 108 x Pal	10,20 x Cj 1020 x Pal
Levelling Profile / Perfil Igualación / Profilé Egalisation	4,5x270x1,3cm 1 3/4"x106 1/4"x1/2"	100214369 L165004139	G-161	10 x Cj 1000 x Pal	1,08 x Cj 108 x Pal	10,20 x Cj 1020 x Pal
Stair Nosing / Mampelran / Nez de Marche	120x7x3cm 47 1/4"x2 3/4"x1 1/8"	100214396 L165004110	G-163	2 x Cj 200 x Pal	0,17 x Cj 16,80 x Pal	3,28 x Cj 327,80 x Pal

NEW

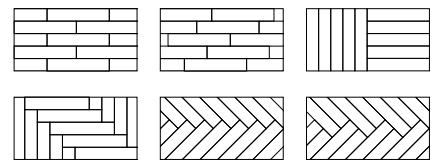

SUGGESTED LAYOUT / EJEMPLO COLOCACIÓN / EXEMPLE DE POSE

Tortona

-
- Wenge
 - Fiera
 - Fonte
 - Viale
 - Walnut
 - Palazzo
 - Piazza
 - Strada
 - Borgo

Natural Wood





Tortona 1L Wenge



Description	Format	Codes	Group	Pcs	m2	Kg
Tortona 1L Wenge	14,5x120x1,1cm 5 7/8" x 47 1/4" x 3/8"	100199484 L165003920	G-235	9 x Cj 216 x Pal	1,56 x Cj 37,58 x Pal	14,76 x Cj 354,24 x Pal
Skirting / Zócalo / Plinthe	8x220x1,4cm 3 1/8"x86 5/8"x9/16"	100154922 L165003181	G-128	12 x Cj 600 x Pal	2,11 x Cj 105,60 x Pal	16,56 x Cj 828 x Pal
Transition Profile / Perfil Transición / Profilé Jointoiment	4x270x1,3cm 1 5/8"x106 1/4"x1/2"	100154920 L165003180	G-161	10 x Cj 1000 x Pal	1,08 x Cj 108 x Pal	10,20 x Cj 1020 x Pal
Levelling Profile / Perfil Igualación / Profilé Égalisation	4,5x270x1,3cm 1 3/4"x106 1/4"x1/2"	100154897 L165003179	G-161	10 x Cj 1000 x Pal	1,08 x Cj 108 x Pal	10,20 x Cj 1020 x Pal
Stair Nosing / Mampelan / Nez de Marche	120x7x3cm 47 1/4"x2 3/4"x1 1/8"	100176610 L165003667	G-163	2 x Cj 200 x Pal	0,17 x Cj 16,80 x Pal	3,28 x Cj 327,80 x Pal

Due to better usage of the wood, any order of this reference may contain mean percentage tables of between 10% y 15%.

Por un mejor aprovechamiento de la madera, cualquier pedido de esta referencia puede contener un porcentaje de medias tablas de entre 10% y 15%.

Pour mieux mettre à profit le bois, toute commande portant sur cette référence peut contenir un pourcentage de demi-planches de 10% y 15%.



Tortona 1L Fiera

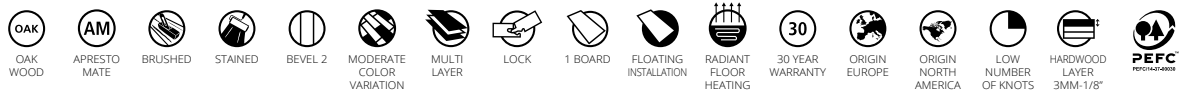

Description	Format	Codes	Group	Pcs	m2	Kg
Tortona 1L Fiera	14,5x120x1,1cm 5 7/8" x 47 1/4" x 3/8"	100199471 L165003916	G-235	9 x Cj 216 x Pal	1,56 x Cj 37,58 x Pal	14,76 x Cj 354,24 x Pal
Skirting / Zócalo / Plinthe	8x220x1,4cm 3 1/8"x86 5/8"x9/16"	100153238 L165003114	G-128	12 x Cj 600 x Pal	2,11 x Cj 105,60 x Pal	16,56 x Cj 828 x Pal
Transition Profile / Perfil Transición / Profilé Jointoiment	4x270x1,3cm 1 5/8"x106 1/4"x1/2"	100153234 L165003107	G-161	10 x Cj 1000 x Pal	1,08 x Cj 108 x Pal	10,20 x Cj 1020 x Pal
Levelling Profile / Perfil Igualación / Profilé Égalisation	4,5x270x1,3cm 1 3/4"x106 1/4"x1/2"	100153230 L165003105	G-161	10 x Cj 1000 x Pal	1,08 x Cj 108 x Pal	10,20 x Cj 1020 x Pal
Stair Nosing / Mampelan / Nez de Marche	120x7x3cm 47 1/4"x2 3/4"x1 1/8"	100176586 L165003650	G-163	2 x Cj 200 x Pal	0,17 x Cj 16,80 x Pal	3,28 x Cj 327,80 x Pal

Due to better usage of the wood, any order of this reference may contain mean percentage tables of between 10% y 15%.

Por un mejor aprovechamiento de la madera, cualquier pedido de esta referencia puede contener un porcentaje de medias tablas de entre 10% y 15%.

Pour mieux mettre à profit le bois, toute commande portant sur cette référence peut contenir un pourcentage de demi-planches de 10% y 15%.

Tortona



Tortona 1L Fonte



Description	Format	Codes	Group	Pcs	m2	Kg
Tortona 1L Fonte	14,5x120x1,1cm 5 7/8"x 47 1/4"x3/8"	100199447 L165003921	G-235	9 x Cj 216 x Pal	1,56 x Cj 37,58 x Pal	14,76 x Cj 354,24 x Pal
Skirting / Zócalo / Plinthe	8x220x1,4cm 3 1/8"x86 5/8"x9/16"	100153239 L165003111	G-128	12 x Cj 600 x Pal	2,11 x Cj 105,60 x Pal	16,56 x Cj 828 x Pal
Transition Profile / Perfil Transición / Profilé Jointoiment	4x270x1,3cm 1 5/8"x106 1/4"x1/2"	100153235 L165003112	G-161	10 x Cj 1000 x Pal	1,08 x Cj 108 x Pal	10,20 x Cj 1020 x Pal
Levelling Profile / Perfil Igualación / Profilé Égalisation	4,5x270x1,3cm 1 3/4"x106 1/4"x1/2"	100153231 L165003113	G-161	10 x Cj 1000 x Pal	1,08 x Cj 108 x Pal	10,20 x Cj 1020 x Pal
Stair Nosing / Mampelran / Nez de Marche	120x7x3cm 47 1/4"x2 3/4"x1 1/8"	100176578 L165003649	G-163	2 x Cj 200 x Pal	0,17 x Cj 16,80 x Pal	3,28 x Cj 327,80 x Pal

Due to better usage of the wood, any order of this reference may contain mean percentage tables of between 10% y 15%.

Por un mejor aprovechamiento de la madera, cualquier pedido de esta referencia puede contener un porcentaje de medias tablas de entre 10% y 15%.

Pour mieux mettre à profit le bois, toute commande portant sur cette référence peut contenir un pourcentage de demi-planches de 10% y 15%.





Tortona 1L Viale

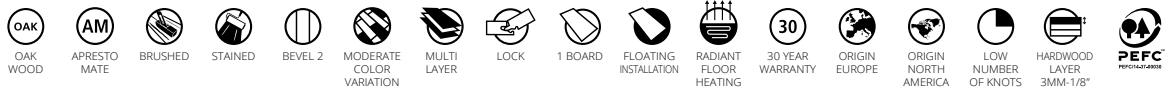

Description	Format	Codes	Group	Pcs	m2	Kg
Tortona 1L Viale	14.5x120x1.1cm 5 7/8" x 47 1/4" x 3/8"	100199490 L165003917	G-235	9 x Cj 216 x Pal	1,56 x Cj 37,58 x Pal	14,76 x Cj 354,24 x Pal
Skirting / Zócalo / Plinthe	8x220x1.4cm 3 1/8"x86 5/8"x9/16"	100153241 L165003109	G-128	12 x Cj 600 x Pal	2,11 x Cj 105,60 x Pal	16,56 x Cj 828 x Pal
Transition Profile / Perfil Transición / Profilé Jointoiment	4x270x1.3cm 1 5/8"x106 1/4"x1/2"	100153237 L165003104	G-161	10 x Cj 1000 x Pal	1,08 x Cj 108 x Pal	10,20 x Cj 1020 x Pal
Levelling Profile / Perfil Igualación / Profilé Égalisation	4,5x270x1,3cm 1 3/4"x106 1/4"x1/2"	100153233 L165003108	G-161	10 x Cj 1000 x Pal	1,08 x Cj 108 x Pal	10,20 x Cj 1020 x Pal
Stair Nosing / Mampierlan / Nez de Marche	120x7x3cm 47 1/4"x2 3/4"x1 1/8"	100176579 L165003671	G-163	2 x Cj 200 x Pal	0,17 x Cj 16,80 x Pal	3,28 x Cj 327,80 x Pal

Due to better usage of the wood, any order of this reference may contain mean percentage tables of between 10% y 15%.

Por un mejor aprovechamiento de la madera, cualquier pedido de esta referencia puede contener un porcentaje de medias tablas de entre 10% y 15%.

Pour mieux mettre à profit le bois, toute commande portant sur cette référence peut contenir un pourcentage de demi-planches de 10% y 15%.

Natural Wood



Tortona 1L Walnut

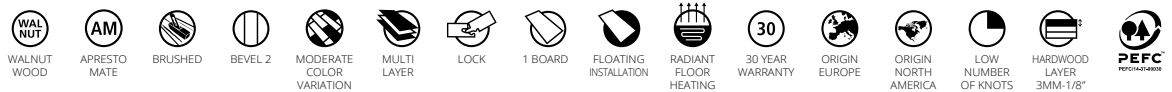

Description	Format	Codes	Group	Pcs	m2	Kg
Tortona 1L Walnut	14.5x120x1.1cm 5 7/8" x 47 1/4" x 3/8"	100199462 L165003915	G-260	9 x Cj 216 x Pal	1,56 x Cj 37,58 x Pal	14,76 x Cj 354,24 x Pal
Skirting / Zócalo / Plinthe	8x220x1.4cm 3 1/8"x86 5/8"x9/16"	100153898 L165003125	G-128	12 x Cj 600 x Pal	2,11 x Cj 105,60 x Pal	16,56 x Cj 828 x Pal
Transition Profile / Perfil Transición / Profilé Jointoiment	4x270x1.3cm 1 5/8"x106 1/4"x1/2"	100153891 L165003128	G-161	10 x Cj 1000 x Pal	1,08 x Cj 108 x Pal	10,20 x Cj 1020 x Pal
Levelling Profile / Perfil Igualación / Profilé Égalisation	4,5x270x1,3cm 1 3/4"x106 1/4"x1/2"	100153884 L165003122	G-161	10 x Cj 1000 x Pal	1,08 x Cj 108 x Pal	10,20 x Cj 1020 x Pal
Stair Nosing / Mampierlan / Nez de Marche	120x7x3cm 47 1/4"x2 3/4"x1 1/8"	100176588 L165003670	G-163	2 x Cj 200 x Pal	0,17 x Cj 16,80 x Pal	3,28 x Cj 327,80 x Pal

Due to better usage of the wood, any order of this reference may contain mean percentage tables of between 10% y 15%.

Por un mejor aprovechamiento de la madera, cualquier pedido de esta referencia puede contener un porcentaje de medias tablas de entre 10% y 15%.

Pour mieux mettre à profit le bois, toute commande portant sur cette référence peut contenir un pourcentage de demi-planches de 10% y 15%.

Tortona



Tortona 1L Palazzo

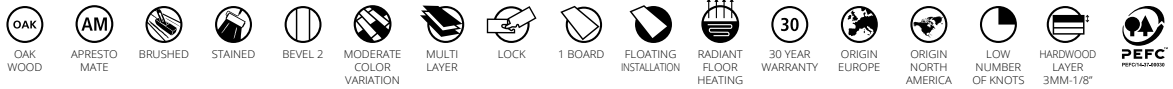

Description	Format	Codes	Group	Pcs	m2	Kg
Tortona 1L Palazzo	14,5x120x1,1cm 5 7/8" x 47 1/4" x 3/8"	100199448 L165003919	G-235	9 x Cj 216 x Pal	1,56 x Cj 37,58 x Pal	14,76 x Cj 354,24 x Pal
Skirting / Zócalo / Plinthe	8x220x1,4cm 3 1/8" x 86 5/8" x 9/16"	100153240 L165003103	G-128	12 x Cj 600 x Pal	2,11 x Cj 105,60 x Pal	16,56 x Cj 828 x Pal
Transition Profile / Perfil Transición / Profilé Jointolement	4x270x1,3cm 1 5/8" x 106 1/4" x 1/2"	100153236 L165003110	G-161	10 x Cj 1000 x Pal	1,08 x Cj 108 x Pal	10,20 x Cj 1020 x Pal
Levelling Profile / Perfil Igualación / Profilé Égalisation	4,5x270x1,3cm 1 3/4" x 106 1/4" x 1/2"	100153232 L165003106	G-161	10 x Cj 1000 x Pal	1,08 x Cj 108 x Pal	10,20 x Cj 1020 x Pal
Stair Nosing / Mampelran / Nez de Marche	120x7x3cm 47 1/4" x 2 3/4" x 1 1/8"	100176605 L165003662	G-163	2 x Cj 200 x Pal	0,17 x Cj 16,80 x Pal	3,28 x Cj 327,80 x Pal

• STOCK

Due to better usage of the wood, any order of this reference may contain mean percentage tables of between 10% y 15%.

Por un mejor aprovechamiento de la madera, cualquier pedido de esta referencia puede contener un porcentaje de medias tablas de entre 10% y 15%.

Pour mieux mettre à profit le bois, toute commande portant sur cette référence peut contenir un pourcentage de demi-planches de 10% y 15%.



Floor Coverings Tortona 1L Walnut



Tortona 1L Piazza



Description	Format	Codes	Group	Pcs	m2	Kg
Tortona 1L Piazza	14,5x120x1,1cm	100199449	G-235	9 x Cj	1,56 x Cj	14,76 x Cj
	5 7/8"x 47 1/4"x3/8"	L165003918		216 x Pal	37,58 x Pal	354,24 x Pal
Skirting / Zócalo / Plinthe	8x220x1,4cm	100153896	G-128	12 x Cj	2,11 x Cj	16,56 x Cj
	3 1/8"x86 5/8"x9/16"	L165003124		600 x Pal	105,60 x Pal	828 x Pal
Transition Profile / Perfil Transición / Profilé Jointoiment	4x270x1,3cm	100153889	G-161	10 x Cj	1,08 x Cj	10,20 x Cj
	1 5/8"x106 1/4"x1/2"	L165003123		1000 x Pal	108 x Pal	1020 x Pal
Levelling Profile / Perfil Igualación / Profilé Égalisation	4,5x270x1,3cm	100153882	G-161	10 x Cj	1,08 x Cj	10,20 x Cj
	1 3/4"x106 1/4"x1/2"	L165003121		1000 x Pal	108 x Pal	1020 x Pal
Stair Nosing / Mampierlan / Nez de Marche	120x7x3cm	100176587	G-163	2 x Cj	0,17 x Cj	3,28 x Cj
	47 1/4"x2 3/4"x1 1/8"	L165003663		200 x Pal	16,80 x Pal	327,80 x Pal

• STOCK

Due to better usage of the wood, any order of this reference may contain mean percentage tables of between 10% y 15%.

Por un mejor aprovechamiento de la madera, cualquier pedido de esta referencia puede contener un porcentaje de medias tablas de entre 10% y 15%.

Pour mieux mettre à profit le bois, toute commande portant sur cette référence peut contenir un pourcentage de demi-planches de 10% y 15%.



Tortona 1L Strada

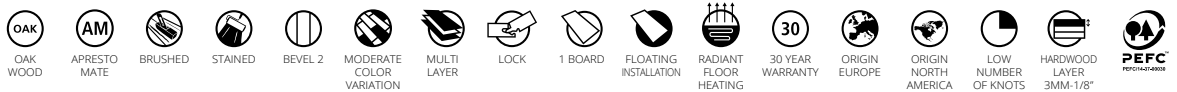

Description	Format	Codes	Group	Pcs	m2	Kg
Tortona 1L Strada	14,5x120x1,1cm	100199483	G-235	9 x Cj	1,56 x Cj	14,76 x Cj
	5 7/8"x 47 1/4"x3/8"	L165003914		216 x Pal	37,58 x Pal	354,24 x Pal
Skirting / Zócalo / Plinthe	8x220x1,4cm	100153897	G-128	12 x Cj	2,11 x Cj	16,56 x Cj
	3 1/8"x86 5/8"x9/16"	L165003127		600 x Pal	105,60 x Pal	828 x Pal
Transition Profile / Perfil Transición / Profilé Jointoiment	4x270x1,3cm	100153890	G-161	10 x Cj	1,08 x Cj	10,20 x Cj
	1 5/8"x106 1/4"x1/2"	L165003126		1000 x Pal	108 x Pal	1020 x Pal
Levelling Profile / Perfil Igualación / Profilé Égalisation	4,5x270x1,3cm	100153883	G-161	10 x Cj	1,08 x Cj	10,20 x Cj
	1 3/4"x106 1/4"x1/2"	L165003120		1000 x Pal	108 x Pal	1020 x Pal
Stair Nosing / Mampierlan / Nez de Marche	120x7x3cm	100176606	G-163	2 x Cj	0,17 x Cj	3,28 x Cj
	47 1/4"x2 3/4"x1 1/8"	L165003669		200 x Pal	16,80 x Pal	327,80 x Pal

• STOCK

Due to better usage of the wood, any order of this reference may contain mean percentage tables of between 10% y 15%.

Por un mejor aprovechamiento de la madera, cualquier pedido de esta referencia puede contener un porcentaje de medias tablas de entre 10% y 15%.

Pour mieux mettre à profit le bois, toute commande portant sur cette référence peut contenir un pourcentage de demi-planches de 10% y 15%.

Tortona



Tortona 1L Borgo

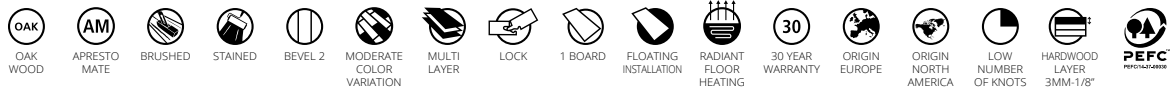

Description	Format	Codes	Group	Pcs	m2	Kg
Tortona 1L Borgo	14,5x120x1,1cm 5 7/8"x 47 1/4"x3/8"	100199482 L165003922	G-235	9 x Cj 216 x Pal	1,56 x Cj 37,58 x Pal	14,76 x Cj 354,24 x Pal
Skirting / Zócalo / Plinthe	8x220x1,4cm 3 1/8"x86 5/8"x9/16"	100154067 L165003143	G-128	12 x Cj 600 x Pal	2,11 x Cj 105,60 x Pal	16,56 x Cj 828 x Pal
Transition Profile / Perfil Transición / Profilé Jointoiment	4x270x1,3cm 1 5/8"x106 1/4"x1/2"	100154063 L165003142	G-161	10 x Cj 1000 x Pal	1,08 x Cj 108 x Pal	10,20 x Cj 1020 x Pal
Levelling Profile / Perfil Igualación / Profilé Egalisation	4,5x270x1,3cm 1 3/4"x106 1/4"x1/2"	100154055 L165003137	G-161	10 x Cj 1000 x Pal	1,08 x Cj 108 x Pal	10,20 x Cj 1020 x Pal
Stair Nosing / Mampelan / Nez de Marche	120x7x3cm 47 1/4"x2 3/4"x1 1/8"	100176604 L165003651	G-163	2 x Cj 200 x Pal	0,17 x Cj 16,80 x Pal	3,28 x Cj 327,80 x Pal

Due to better usage of the wood, any order of this reference may contain mean percentage tables of between 10% y 15%.

Por un mejor aprovechamiento de la madera, cualquier pedido de esta referencia puede contener un porcentaje de medias tablas de entre 10% y 15%.

Pour mieux mettre à profit le bois, toute commande portant sur cette référence peut contenir un pourcentage de demi-planches de 10% y 15%.



Floor Coverings Tortona 1L Strada

Treville

—
Chocolate
Concrete
Leather
Suede
Mist

Floor Coverings Treville 1L Mist / Complementary Products Karon Circle Crema Italia Classico, Tower Mirror Nogal Warm

The use of natural wood in baths shall be the responsibility of the client. / El uso de la madera natural en baños es bajo la responsabilidad del cliente. / Il est de la responsabilité du client l'utilisation du bois naturel dans les bains





Treville 1L
Chocolate

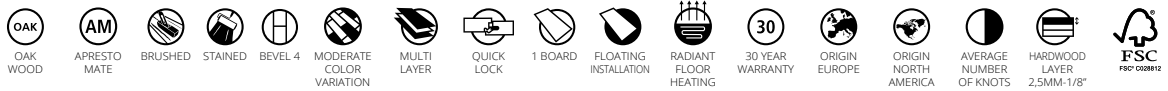

Description	Format	Codes	Group	Pcs	m2	Kg
Treville 1L Chocolate	13x109,2x1,4cm 5 1/8"x43"x1/2"	100213872 L165004047	G-238	7 x Cj 210 x Pal	0,99 x Cj 29,81 x Pal	7,49 x Cj 224,91 x Pal
Skirting / Zócalo / Plinthe	8x220x1,4cm	100214440 L165004134	G-128	12 x Cj 600 x Pal	2,11 x Cj 105,60 x Pal	16,56 x Cj 828 x Pal
Transition Profile / Perfil Transición / Profilé Jointoiment	4x270x1,3cm	100214430 L165004132	G-161	10 x Cj 1000 x Pal	1,08 x Cj 108 x Pal	10,20 x Cj 1020 x Pal
Levelling Profile / Perfil Igualación / Profilé Égalisation	4,5x270x1,3cm	100214349 L165004088	G-161	10 x Cj 1000 x Pal	1,08 x Cj 108 x Pal	10,20 x Cj 1020 x Pal
Stair Nosing / Mampierlan / Nez de Marche	120x7x3cm	100214397 L165004097	G-163	2 x Cj 200 x Pal	0,17 x Cj 16,80 x Pal	3,28 x Cj 327,80 x Pal

NEW

Due to better usage of the wood, any order of this reference may contain mean percentage tables of between 20% y 25%.

Por un mejor aprovechamiento de la madera, cualquier pedido de esta referencia puede contener un porcentaje de medias tablas de entre 20% y 25%.

Pour mieux mettre à profit le bois, toute commande portant sur cette référence peut contenir un pourcentage de demi-planches de 20% y 25%.

Natural Wood



Treville 1L
Concrete

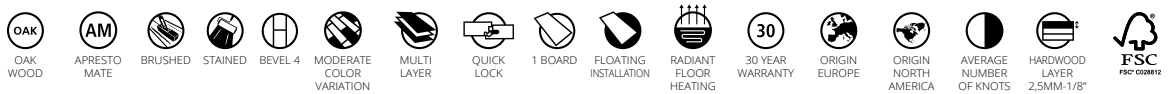

Description	Format	Codes	Group	Pcs	m2	Kg
Treville 1L Concrete	13x109,2x1,4cm 5 1/8"x43"x1/2"	100213818 L165004051	G-238	7 x Cj 210 x Pal	0,99 x Cj 29,81 x Pal	7,49 x Cj 224,91 x Pal
Skirting / Zócalo / Plinthe	8x220x1,4cm	100214450 L165004093	G-128	12 x Cj 600 x Pal	2,11 x Cj 105,60 x Pal	16,56 x Cj 828 x Pal
Transition Profile / Perfil Transición / Profilé Jointoiment	4x270x1,3cm	100214422 L165004113	G-161	10 x Cj 1000 x Pal	1,08 x Cj 108 x Pal	10,20 x Cj 1020 x Pal
Levelling Profile / Perfil Igualación / Profilé Égalisation	4,5x270x1,3cm	100214400 L165004094	G-161	10 x Cj 1000 x Pal	1,08 x Cj 108 x Pal	10,20 x Cj 1020 x Pal
Stair Nosing / Mampierlan / Nez de Marche	120x7x3cm	100214378 L165004118	G-163	2 x Cj 200 x Pal	0,17 x Cj 16,80 x Pal	3,28 x Cj 327,80 x Pal

NEW

Due to better usage of the wood, any order of this reference may contain mean percentage tables of between 20% y 25%.

Por un mejor aprovechamiento de la madera, cualquier pedido de esta referencia puede contener un porcentaje de medias tablas de entre 20% y 25%.

Pour mieux mettre à profit le bois, toute commande portant sur cette référence peut contenir un pourcentage de demi-planches de 20% y 25%.

Treville



Treville 1L Leather

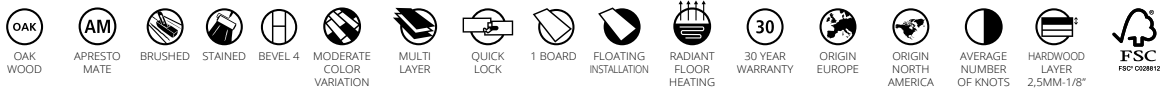

Description	Format	Codes	Group	Pcs	m2	Kg
Treville 1L Leather	13x109,2x1,4cm 5 1/8"x43"x1/2"	100213873 L165004048	G-238	7 x Cj 210 x Pal	0,99 x Cj 29,81 x Pal	7,49 x Cj 224,91 x Pal
Skirting / Zócalo / Plinthe	8x220x1,4cm 3 1/8"x86 5/8"x9/16"	100214425 L165004140	G-128	12 x Cj 600 x Pal	2,11 x Cj 105,60 x Pal	16,56 x Cj 828 x Pal
Transition Profile / Perfil Transición / Profilé Jointolement	4x270x1,3cm 1 5/8"x106 1/4"x1/2"	100214406 L165004100	G-161	10 x Cj 1000 x Pal	1,08 x Cj 108 x Pal	10,20 x Cj 1020 x Pal
Levelling Profile / Perfil Igualación / Profilé Égalisation	4,5x270x1,3cm 1 3/4"x106 1/4"x1/2"	100214410 L165004101	G-161	10 x Cj 1000 x Pal	1,08 x Cj 108 x Pal	10,20 x Cj 1020 x Pal
Stair Nosing / Mampelran / Nez de Marche	120x7x3cm 47 1/4"x2 3/4"x1 1/8"	100214402 L165004126	G-163	2 x Cj 200 x Pal	0,17 x Cj 16,80 x Pal	3,28 x Cj 327,80 x Pal

NEW

Due to better usage of the wood, any order of this reference may contain mean percentage tables of between 20% y 25%.

Por un mejor aprovechamiento de la madera, cualquier pedido de esta referencia puede contener un porcentaje de medias tablas de entre 20% y 25%.

Pour mieux mettre à profit le bois, toute commande portant sur cette référence peut contenir un pourcentage de demi-planches de 20% y 25%.



Treville 1L Suede



Description	Format	Codes	Group	Pcs	m2	Kg
Treville 1L Suede	13x109,2x1,4cm 5 1/8"x43"x1/2"	100213874 L165004050	G-238	7 x Cj 210 x Pal	0,99 x Cj 29,81 x Pal	7,49 x Cj 224,91 x Pal
Skirting / Zócalo / Plinthe	8x220x1,4cm 3 1/8"x86 5/8"x9/16"	100214451 L165004105	G-128	12 x Cj 600 x Pal	2,11 x Cj 105,60 x Pal	16,56 x Cj 828 x Pal
Transition Profile / Perfil Transición / Profilé Jointolement	4x270x1,3cm 1 5/8"x106 1/4"x1/2"	100214407 L165004103	G-161	10 x Cj 1000 x Pal	1,08 x Cj 108 x Pal	10,20 x Cj 1020 x Pal
Levelling Profile / Perfil Igualación / Profilé Égalisation	4,5x270x1,3cm 1 3/4"x106 1/4"x1/2"	100214359 L165004102	G-161	10 x Cj 1000 x Pal	1,08 x Cj 108 x Pal	10,20 x Cj 1020 x Pal
Stair Nosing / Mampelran / Nez de Marche	120x7x3cm 47 1/4"x2 3/4"x1 1/8"	100214404 L165004121	G-163	2 x Cj 200 x Pal	0,17 x Cj 16,80 x Pal	3,28 x Cj 327,80 x Pal

NEW

Due to better usage of the wood, any order of this reference may contain mean percentage tables of between 20% y 25%.

Por un mejor aprovechamiento de la madera, cualquier pedido de esta referencia puede contener un porcentaje de medias tablas de entre 20% y 25%.

Pour mieux mettre à profit le bois, toute commande portant sur cette référence peut contenir un pourcentage de demi-planches de 20% y 25%.



Treville 1L Mist



Description	Format	Codes	Group	Pcs	m2	Kg
Treville 1L Mist	13x109,2x1,4cm 5 1/8"x43"x1/2"	100213819 L165004049	G-238	7 x Cj 210 x Pal	0,99 x Cj 29,81 x Pal	7,49 x Cj 224,91 x Pal
Skirting / Zócalo / Plinthe	8x220x1,4cm 3 1/8"x86 5/8"x9/16"	100214460 L165004124	G-128	12 x Cj 600 x Pal	2,11 x Cj 105,60 x Pal	16,56 x Cj 828 x Pal
Transition Profile / Perfil Transición / Profilé jointoiment	4x270x1,3cm 1 5/8"x106 1/4"x1/2"	100214418 L165004112	G-161	10 x Cj 1000 x Pal	1,08 x Cj 108 x Pal	10,20 x Cj 1020 x Pal
Levelling Profile / Perfil Igualación / Profilé Égalisation	4,5x270x1,3cm 1 3/4"x106 1/4"x1/2"	100214377 L165004137	G-161	10 x Cj 1000 x Pal	1,08 x Cj 108 x Pal	10,20 x Cj 1020 x Pal
Stair Nosing / Mampelian / Nez de Marche	120x7x3cm 47 1/4"x2 3/4"x1 1/8"	100214403 L165004117	G-163	2 x Cj 200 x Pal	0,17 x Cj 16,80 x Pal	3,28 x Cj 327,80 x Pal

NEW

Due to better usage of the wood, any order of this reference may contain mean percentage tables of between 20% y 25%.

Por un mejor aprovechamiento de la madera, cualquier pedido de esta referencia puede contener un porcentaje de medias tablas de entre 20% y 25%.

Pour mieux mettre à profit le bois, toute commande portant sur cette référence peut contenir un pourcentage de demi-planches de 20% y 25%.



Artisan

—
Wild
Coconut
Woven
Linen

Natural Wood





Artisan 1L Wild



Description	Format	Codes	Group	Pcs	m2	Kg
Artisan 1L Wild	19x190x1,5cm 7 1/2"x74 3/4"x5/8"	100161272 L165003406	G-268	6 x Cj 210 x Pal	2,17 x Cj 75,81 x Pal	21,20 x Cj 741,93 x Pal
Skirting / Zócalo / Plinthe	8x220x1,4cm 3 1/8"x86 5/8"x9/16"	100162084 L165003437	G-128	12 x Cj 600 x Pal	2,11 x Cj 105,60 x Pal	16,52 x Cj 826,20 x Pal
Transition Profile / Perfil Transición / Profilé Jointoiment	4x270x1,3cm 1 5/8"x106 1/4"x1/2"	100162058 L165003434	G-161	10 x Cj 1000 x Pal	1,08 x Cj 108 x Pal	10,20 x Cj 1020 x Pal
Levelling Profile / Perfil Igualación / Profilé Égalisation	4,5x270x1,3cm 1 3/4"x106 1/4"x1/2"	100162087 L165003436	G-161	10 x Cj 1000 x Pal	1,08 x Cj 108 x Pal	10,20 x Cj 1020 x Pal
Stair Nosing / Mampelan / Nez de Marche	120x7x3cm 47 1/4"x2 3/4"x1 1/8"	100176730 L165003672	G-163	2 x Cj 200 x Pal	0,17 x Cj 16,80 x Pal	3,28 x Cj 327,80 x Pal

Due to better usage of the wood, any order of this reference may contain mean percentage tables of between 20% y 25%.

Por un mejor aprovechamiento de la madera, cualquier pedido de esta referencia puede contener un porcentaje de medias tablas de entre 20% y 25%.

Pour mieux mettre à profit le bois, toute commande portant sur cette référence peut contenir un pourcentage de demi-planches de 20% y 25%.

Natural Wood



Artisan 1L Coconut

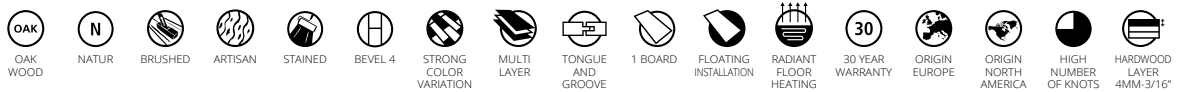

Description	Format	Codes	Group	Pcs	m2	Kg
Artisan 1L Coconut	19x190x1,5cm 7 1/2"x74 3/4"x5/8"	100103574 L160803284	G-268	6 x Cj 210 x Pal	2,17 x Cj 75,81 x Pal	21,20 x Cj 741,93 x Pal
Skirting / Zócalo / Plinthe	8x220x1,4cm 3 1/8"x86 5/8"x9/16"	100111711 L165002380	G-128	12 x Cj 600 x Pal	2,11 x Cj 105,60 x Pal	16,56 x Cj 828 x Pal
Transition Profile / Perfil Transición / Profilé Jointoiment	4x270x1,3cm 1 5/8"x106 1/4"x1/2"	100114967 L165002600	G-161	10 x Cj 1000 x Pal	1,08 x Cj 108 x Pal	10,20 x Cj 1020 x Pal
Levelling Profile / Perfil Igualación / Profilé Égalisation	4,5x270x1,3cm 1 3/4"x106 1/4"x1/2"	100114965 L165002599	G-161	10 x Cj 1000 x Pal	1,08 x Cj 108 x Pal	10,20 x Cj 1020 x Pal
Stair Nosing / Mampelan / Nez de Marche	120x7x3cm 47 1/4"x2 3/4"x1 1/8"	100176565 L165003615	G-163	2 x Cj 200 x Pal	0,17 x Cj 16,80 x Pal	3,28 x Cj 327,80 x Pal

STOCK

Due to better usage of the wood, any order of this reference may contain mean percentage tables of between 20% y 25%.

Por un mejor aprovechamiento de la madera, cualquier pedido de esta referencia puede contener un porcentaje de medias tablas de entre 20% y 25%.

Pour mieux mettre à profit le bois, toute commande portant sur cette référence peut contenir un pourcentage de demi-planches de 20% y 25%.

Artisan



Artisan 1L Woven



Description	Format	Codes	Group	Pcs	m2	Kg
Artisan 1L Woven	19x190x1,5cm 7 1/2"x74 3/4"x5/8"	100103576 L160803285	G-268	6 x Cj 210 x Pal	2,17 x Cj 75,81 x Pal	21,20 x Cj 741,93 x Pal
Skirting / Zócalo / Plinthe	8x220x1,4cm 3 1/8"x86 5/8"x9/16"	100113839 L165002570	G-128	12 x Cj 600 x Pal	2,11 x Cj 105,60 x Pal	16,56 x Cj 828 x Pal
Transition Profile / Perfil Transición / Profilé Jointolement	4x270x1,3cm 1 5/8"x106 1/4"x1/2"	100113831 L165002567	G-161	10 x Cj 1000 x Pal	1,08 x Cj 108 x Pal	10,20 x Cj 1020 x Pal
Levelling Profile / Perfil Igualación / Profilé Egalisation	4,5x270x1,3cm 1 3/4"x106 1/4"x1/2"	100113809 L165002563	G-161	10 x Cj 1000 x Pal	1,08 x Cj 108 x Pal	10,20 x Cj 1020 x Pal
Stair Nosing / Mampelran / Nez de Marche	120x7x3cm 47 1/4"x2 3/4"x1 1/8"	100176558 L165003613	G-163	2 x Cj 200 x Pal	0,17 x Cj 16,80 x Pal	3,28 x Cj 327,80 x Pal

STOCK

Due to better usage of the wood, any order of this reference may contain mean percentage tables of between 20% y 25%.

Por un mejor aprovechamiento de la madera, cualquier pedido de esta referencia puede contener un porcentaje de medias tablas de entre 20% y 25%.

Pour mieux mettre à profit le bois, toute commande portant sur cette référence peut contenir un pourcentage de demi-planches de 20% y 25%.



Artisan 1L Linen



Description	Format	Codes	Group	Pcs	m2	Kg
Artisan 1L Linen	19x190x1,5cm 7 1/2"x74 3/4"x5/8"	100103575 L160803286	G-268	6 x Cj 210 x Pal	2,17 x Cj 75,81 x Pal	21,20 x Cj 741,93 x Pal
Skirting / Zócalo / Plinthe	8x220x1,4cm 3 1/8"x86 5/8"x9/16"	100113837 L165002571	G-128	12 x Cj 600 x Pal	2,11 x Cj 105,60 x Pal	16,56 x Cj 828 x Pal
Transition Profile / Perfil Transición / Profilé Jointolement	4x270x1,3cm 1 5/8"x106 1/4"x1/2"	100113830 L165002564	G-161	10 x Cj 1000 x Pal	1,08 x Cj 108 x Pal	10,20 x Cj 1020 x Pal
Levelling Profile / Perfil Igualación / Profilé Egalisation	4,5x270x1,3cm 1 3/4"x106 1/4"x1/2"	100113808 L165002558	G-161	10 x Cj 1000 x Pal	1,08 x Cj 108 x Pal	10,20 x Cj 1020 x Pal
Stair Nosing / Mampelran / Nez de Marche	120x7x3cm 47 1/4"x2 3/4"x1 1/8"	100176542 L165003614	G-163	2 x Cj 200 x Pal	0,17 x Cj 16,80 x Pal	3,28 x Cj 327,80 x Pal

STOCK

Due to better usage of the wood, any order of this reference may contain mean percentage tables of between 20% y 25%.

Por un mejor aprovechamiento de la madera, cualquier pedido de esta referencia puede contener un porcentaje de medias tablas de entre 20% y 25%.

Pour mieux mettre à profit le bois, toute commande portant sur cette référence peut contenir un pourcentage de demi-planches de 20% y 25%.

Advance

Marron
Warm Oak
Natural
Blanco

Floor Coverings Advance 1L Marron / **Complementary Products** TONO Elements Habana Dark

The use of natural wood in baths shall be the responsibility of the client. / *El uso de la madera natural en baños es bajo la responsabilidad del cliente. / Il est de la responsabilité du client l'utilisation du bois naturel dans les bains*





Advance
1L Marron

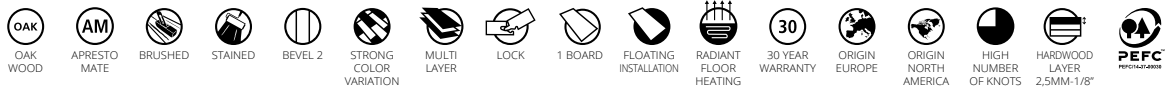

Description	Format	Codes	Group	Pcs	m2	Kg
Advance 1L Marron	18x220x1,1cm 7 1/8"x86 5/8"x3/8"	100107308 L160241069	G-240	6 x Cj 192 x Pal	2,38 x Cj 76,03 x Pal	22,11 x Cj 707,52 x Pal
Skirting / Zócalo / Plinthe	8x220x1,4cm 3 1/8"x86 5/8"x9/16"	100113741 L165002512	G-128	12 x Cj 600 x Pal	2,11 x Cj 105,60 x Pal	16,56 x Cj 828 x Pal
Transition Profile / Perfil Transición / Profilé Jointoiment	4x270x1,3cm 1 5/8"x106 1/4"x1/2"	100113729 L165002510	G-161	10 x Cj 1000 x Pal	1,08 x Cj 108 x Pal	10,20 x Cj 1020 x Pal
Levelling Profile / Perfil Igualación / Profilé Égalisation	4,5x270x1,3cm 1 3/4"x106 1/4"x1/2"	100113727 L165002513	G-161	10 x Cj 1000 X Pal	1,08 x Cj 108 x Pal	10,20 x Cj 1020 x Pal
Stair Nosing / Mampelan / Nez de Marche	120x7x3cm 47 1/4"x2 3/4"x1 1/8"	100176564 L165003619	G-163	2 x Cj 200 x Pal	0,17 x Cj 16,80 x Pal	3,28 x Cj 327,80 x Pal

Due to better usage of the wood, any order of this reference may contain mean percentage tables of between 15% y 20%.

Por un mejor aprovechamiento de la madera, cualquier pedido de esta referencia puede contener un porcentaje de medias tablas de entre 15% y 20%.

Pour mieux mettre à profit le bois, toute commande portant sur cette référence peut contenir un pourcentage de demi-planches de 15% y 20%.

Natural Wood



Advance 1L
Warm Oak

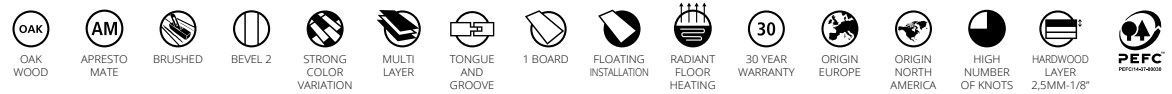

Description	Format	Codes	Group	Pcs	m2	Kg
Advance 1L Warm Oak	18,8x220x1,4cm 7 3/8"x86 5/8"x1/2"	100104966 L160803287	G-240	6 x Cj 300 x Pal	2,48 x Cj 124,08 x Pal	19,80 x Cj 990 x Pal
Skirting / Zócalo / Plinthe	8x220x1,4cm 3 1/8"x86 5/8"x9/16"	100114258 L165002531	G-128	12 x Cj 600 x Pal	2,11 x Cj 105,60 x Pal	16,56 x Cj 828 x Pal
Transition Profile / Perfil Transición / Profilé Jointoiment	4x270x1,3cm 1 5/8"x106 1/4"x1/2"	100114249 L165002534	G-161	10 x Cj 1000 x Pal	1,08 x Cj 108 x Pal	10,20 x Cj 1020 x Pal
Levelling Profile / Perfil Igualación / Profilé Égalisation	4,5x270x1,3cm 1 3/4"x106 1/4"x1/2"	100114233 L165002516	G-161	10 x Cj 1000 x Pal	1,08 x Cj 108 x Pal	10,20 x Cj 1020 x Pal
Stair Nosing / Mampelan / Nez de Marche	120x7x3cm 47 1/4"x2 3/4"x1 1/8"	100176570 L165003616	G-163	2 x Cj 200 x Pal	0,17 x Cj 16,80 x Pal	3,28 x Cj 327,80 x Pal

STOCK

Due to better usage of the wood, any order of this reference may contain mean percentage tables of between 15% y 20%.

Por un mejor aprovechamiento de la madera, cualquier pedido de esta referencia puede contener un porcentaje de medias tablas de entre 15% y 20%.

Pour mieux mettre à profit le bois, toute commande portant sur cette référence peut contenir un pourcentage de demi-planches de 15% y 20%.

Advance



Advance 1L Natural

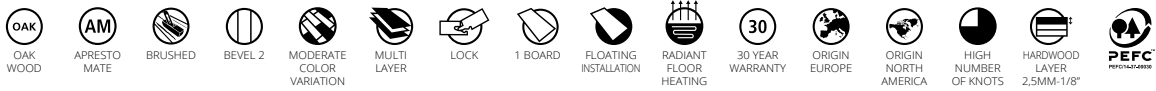

Description	Format	Codes	Group	Pcs	m2	Kg
Advance 1L Natural	18x220x1,1cm	100065917	G-240	6 x Cj	2,38 x Cj	22,11 x Cj
	7 1/8"x86 5/8"x3/8"	L160241051		192 x Pal	76,03 x Pal	707,52 x Pal
Skirting / Zócalo / Plinthe	8x220x1,4cm	100112799	G-128	12 x Cj	2,11 x Cj	16,56 x Cj
	3 1/8"x86 5/8"x9/16"	L165002491		600 x Pal	105,60 x Pal	828 x Pal
Transition Profile / Perfil Transición / Profilé Jointolement	4x270x1,3cm	100112806	G-161	10 x Cj	1,08 x Cj	10,20 x Cj
	1 5/8"x106 1/4"x1/2"	L165002494		1000 x Pal	108 x Pal	1020 x Pal
Levelling Profile / Perfil Igualación / Profilé Egalisation	4,5x270x1,3cm	100112800	G-161	10 x Cj	1,08 x Cj	10,20 x Cj
	1 3/4"x106 1/4"x1/2"	L165002489		1000 x Pal	108 x Pal	1020 x Pal
Stair Nosing / Mampierlan / Nez de Marche	120x7x3cm	100176538	G-163	2 x Cj	0,17 x Cj	3,28 x Cj
	47 1/4"x2 3/4"x1 1/8"	L165003618		200 x Pal	16,80 x Pal	327,80 x Pal

Due to better usage of the wood, any order of this reference may contain mean percentage tables of between 15% y 20%.

Por un mejor aprovechamiento de la madera, cualquier pedido de esta referencia puede contener un porcentaje de medias tablas de entre 15% y 20%.

Pour mieux mettre à profit le bois, toute commande portant sur cette référence peut contenir un pourcentage de demi-planches de 15% y 20%.



Advance 1L Blanco

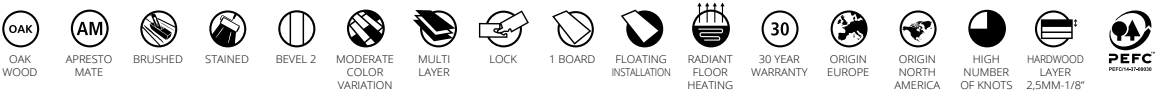

Description	Format	Codes	Group	Pcs	m2	Kg
Advance 1L Blanco	18x220x1,1cm	100086526	G-240	6 x Cj	2,38 x Cj	22,11 x Cj
	7 1/8"x86 5/8"x3/8"	L160241063		192 x Pal	76,03 x Pal	707,52 x Pal
Skirting / Zócalo / Plinthe	8x220x1,4cm	100087350	G-128	12 x Cj	2,11 x Cj	16,52 x Cj
	3 1/8"x86 5/8"x9/16"	L165002252		600 x Pal	105,60 x Pal	826,20 x Pal
Transition Profile / Perfil Transición / Profilé Jointolement	4x270x1,3cm	100087342	G-161	10 x Cj	1,08 x Cj	10,20 x Cj
	1 5/8"x106 1/4"x1/2"	L164204640		1000 x Pal	108 x Pal	1020 x Pal
Levelling Profile / Perfil Igualación / Profilé Egalisation	4,5x270x1,3cm	100087330	G-161	10 x Cj	1,08 x Cj	10,20 x Cj
	1 3/4"x106 1/4"x1/2"	L164532134		1000 x Pal	108 x Pal	1020 x Pal
Stair Nosing / Mampierlan / Nez de Marche	120x7x3cm	100176555	G-163	2 x Cj	0,17 x Cj	3,28 x Cj
	47 1/4"x2 3/4"x1 1/8"	L165003622		200 x Pal	16,80 x Pal	327,80 x Pal

STOCK

Due to better usage of the wood, any order of this reference may contain mean percentage tables of between 15% y 20%.

Por un mejor aprovechamiento de la madera, cualquier pedido de esta referencia puede contener un porcentaje de medias tablas de entre 15% y 20%.

Pour mieux mettre à profit le bois, toute commande portant sur cette référence peut contenir un pourcentage de demi-planches de 15% y 20%.



Advance Premium

—
Albany
Auckland

Natural Wood

Floor Coverings Advance Premium 1L Auckland

The use of natural wood in kitchens shall be the responsibility of the client. / El uso de la madera natural en cocinas es bajo la responsabilidad del cliente. / Il est de la responsabilité du client l'utilisation du bois naturel dans les cuisines.



Advance Premium 1L Auckland

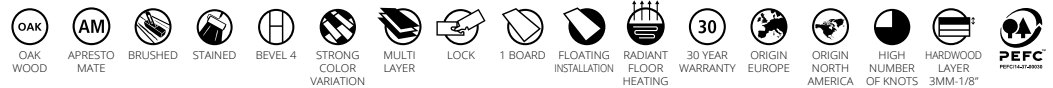

Description	Format	Codes	Group	Pcs	m2	Kg
Advance Premium 1L Auckland	25x240x1,4cm 9 7/8"x94 1/2"x1/2"	100161671 L165003407	G-252	3 x Cj 168 x Pal	1,80 x Cj 100,80 x Pal	22,35 x Cj 1251,94 x Pal
Skirting / Zócalo / Plinthe	8x220x1,4cm 3 1/8"x86 5/8"x9/16"	100162090 L165003438	G-128	12 x Cj 600 x Pal	2,11 x Cj 105,60 x Pal	16,52 x Cj 826,20 x Pal
Transition Profile / Perfil Transición / Profilé Jointoiment	4x270x1,3cm 1 5/8"x106 1/4"x1/2"	100162080 L165003425	G-161	10 x Cj 1000 x Pal	1,08 x Cj 108 x Pal	10,20 x Cj 1020 x Pal
Levelling Profile / Perfil Igualación / Profilé Égalisation	4,5x270x1,3cm 1 3/4"x106 1/4"x1/2"	100162076 L165003428	G-161	10 x Cj 1000 x Pal	1,08 x Cj 108 x Pal	10,20 x Cj 1020 x Pal
Stair Nosing / Mampelan / Nez de Marche	120x7x3cm 47 1/4"x2 3/4"x1 1/8"	100176699 L165003666	G-163	2 x Cj 200 x Pal	0,17 x Cj 16,80 x Pal	3,28 x Cj 327,80 x Pal

Due to better usage of the wood, any order of this reference may contain mean percentage tables of between 20% y 25%.

Por un mejor aprovechamiento de la madera, cualquier pedido de esta referencia puede contener un porcentaje de medias tablas de entre 20% y 25%.

Pour mieux mettre à profit le bois, toute commande portant sur cette référence peut contenir un pourcentage de demi-planches de 20% y 25%.



Advance Premium 1L Albany



Description	Format	Codes	Group	Pcs	m2	Kg
Advance Premium 1L Albany	25x240x1,4cm 9 7/8"x94 1/2"x1/2"	100161661 L165003408	G-252	3 x Cj 168 x Pal	1,80 x Cj 100,80 x Pal	22,35 x Cj 1251,94 x Pal
Skirting / Zócalo / Plinthe	8x220x1,4cm 3 1/8"x86 5/8"x9/16"	100162064 L165003441	G-128	12 x Cj 600 x Pal	2,11 x Cj 105,60 x Pal	16,52 x Cj 826,20 x Pal
Transition Profile / Perfil Transición / Profilé Jointoiment	4x270x1,3cm 1 5/8"x106 1/4"x1/2"	100162049 L165003424	G-161	10 x Cj 1000 x Pal	1,08 x Cj 108 x Pal	10,20 x Cj 1020 x Pal
Levelling Profile / Perfil Igualación / Profilé Égalisation	4,5x270x1,3cm 1 3/4"x106 1/4"x1/2"	100162045 L165003422	G-161	10 x Cj 1000 x Pal	1,08 x Cj 108 x Pal	10,20 x Cj 1020 x Pal
Stair Nosing / Mampelan / Nez de Marche	120x7x3cm 47 1/4"x2 3/4"x1 1/8"	100176727 L165003668	G-163	2 x Cj 200 x Pal	0,17 x Cj 16,80 x Pal	3,28 x Cj 327,80 x Pal

Due to better usage of the wood, any order of this reference may contain mean percentage tables of between 20% y 25%.

Por un mejor aprovechamiento de la madera, cualquier pedido de esta referencia puede contener un porcentaje de medias tablas de entre 20% y 25%.

Pour mieux mettre à profit le bois, toute commande portant sur cette référence peut contenir un pourcentage de demi-planches de 20% y 25%.



Natural Wood

Eden

-
- Wenge
- Brown
- Camel
- Natural
- White
- Sand
- Venice
- Laguna
- Marengo





Eden 1L
Wenge



Description	Format	Codes	Group	Pcs	m2	Kg
Eden 1L Wenge	20x240x2cm	100096821	G-263	4 x Cj	1,92 x Cj	23,04 x Cj
	7 7/8"x94 1/2"x3/4"	L160803273		160 x Pal	76,80 x Pal	921,60 x Pal
Eden 1L Wenge	20x210x2cm	100188759	G-260	4 x Cj	1,68 x Cj	24,80 x Cj
	7 7/8"x82 5/8" x3/4"	L165003840		160 x Pal	67,20 x Pal	993,60 x Pal
Skirting / Zócalo / Plinthe	8x220x1,4cm	100097177	G-128	12 x Cj	2,11 x Cj	29,88 x Cj
	3 1/8"x86 5/8"x9/16"	L168001721		600 x Pal	105,60 x Pal	1494 x Pal
Transition Profile / Perfil Transición / Profilé jointolement	4x270x1,3cm	100097165	G-161	10 x Cj	1,08 x Cj	10,20 x Cj
	1 5/8"x106 1/4"x1/2"	L164532153		1000 x Pal	108 x Pal	1020 x Pal
Levelling Profile / Perfil Igualación / Profilé Égalisation	4,5x270x1,3cm	100097161	G-161	10 x Cj	1,08 x Cj	10,20 x Cj
	1 3/4"x106 1/4"x1/2"	L164705106		1000 x Pal	108 x Pal	1020 x Pal
Stair Nosing / Mampelan / Nez de Marche	120x7x3cm	100176572	G-163	2 x Cj	0,17 x Cj	3,28 x Cj
	47 1/4"x2 3/4"x1 1/8"	L165003630		200 x Pal	16,80 x Pal	327,80 x Pal

*Wood is a natural product, so consistency in length cannot be guaranteed. This range will be supplied in lengths of 240 or 210cm according to availability.

Debido a que la madera es un producto natural, no se puede asegurar el largo de esta serie y se servirá según disponibilidad indistintamente en 240 o 210cm.

Le bois étant un produit naturel, il est impossible de garantir la longueur de cette série et elle sera fournie en fonction des disponibilités aussi bien en 240 qu'en 210cm.

Due to better usage of the wood, any order of this reference may contain mean percentage tables of between 25% y 30% / Por un mejor aprovechamiento de la madera, cualquier pedido de esta referencia puede contener un porcentaje de medias tablas de entre 25% y 30% / Pour mieux mettre à profit le bois, toute commande portant sur cette référence peut contenir un pourcentage de demi-planches de 25% y 30%.

Natural Wood



Eden 1L
Brown



Description	Format	Codes	Group	Pcs	m2	Kg
Eden 1L Brown	20x240x2cm	100086065	G-263	4 x Cj	1,92 x Cj	23,04 x Cj
	7 7/8"x94 1/2"x3/4"	L160803255		160 x Pal	76,80 x Pal	921,60 x Pal
Eden 1L Brown	20x210x2cm	100188749	G-260	4 x Cj	1,68 x Cj	24,80 x Cj
	7 7/8"x82 5/8" x3/4"	L165003837		160 x Pal	67,20 x Pal	993,60 x Pal
Skirting / Zócalo / Plinthe	8x220x1,4cm	100086364	G-128	12 x Cj	2,11 x Cj	29,88 x Cj
	3 1/8"x86 5/8"x9/16"	L168001711		600 x Pal	105,60 x Pal	1494 x Pal
Transition Profile / Perfil Transición / Profilé jointolement	4x270x1,3cm	100086306	G-161	10 x Cj	1,08 x Cj	10,20 x Cj
	1 5/8"x106 1/4"x1/2"	L164532094		1000 x Pal	108 x Pal	1020 x Pal
Levelling Profile / Perfil Igualación / Profilé Égalisation	4,5x270x1,3cm	100086301	G-161	10 x Cj	1,08 x Cj	10,20 x Cj
	1 3/4"x106 1/4"x1/2"	L164705096		1000 x Pal	108 x Pal	1020 x Pal
Stair Nosing / Mampelan / Nez de Marche	120x7x3cm	100176571	G-163	2 x Cj	0,17 x Cj	3,28 x Cj
	47 1/4"x2 3/4"x1 1/8"	L165003624		200 x Pal	16,80 x Pal	327,80 x Pal

STOCK

*Wood is a natural product, so consistency in length cannot be guaranteed. This range will be supplied in lengths of 240 or 210cm according to availability.

Debido a que la madera es un producto natural, no se puede asegurar el largo de esta serie y se servirá según disponibilidad indistintamente en 240 o 210cm.

Le bois étant un produit naturel, il est impossible de garantir la longueur de cette série et elle sera fournie en fonction des disponibilités aussi bien en 240 qu'en 210cm.

Due to better usage of the wood, any order of this reference may contain mean percentage tables of between 25% y 30% / Por un mejor aprovechamiento de la madera, cualquier pedido de esta referencia puede contener un porcentaje de medias tablas de entre 25% y 30% / Pour mieux mettre à profit le bois, toute commande portant sur cette référence peut contenir un pourcentage de demi-planches de 25% y 30%.

Eden



Eden 1L Camel



Description	Format	Codes	Group	Pcs	m2	Kg
Eden 1L Camel	20x240x2cm 7 7/8"x94 1/2"x3/4"	100086066 L160803254	G-263	4 x Cj 160 x Pal	1,92 x Cj 76,80 x Pal	23,04 x Cj 921,60 x Pal
Eden 1L Camel	20x210x2cm 7 7/8"x82 5/8" x3/4"	100188770 L165003842	G-260	4 x Cj 160 x Pal	1,68 x Cj 67,20 x Pal	24,80 x Cj 993,60 x Pal
Skirting / Zócalo / Plinthe	8x220x1,4cm 3 1/8"x86 5/8"x9/16"	100086365 L168001712	G-128	12 x Cj 600 x Pal	2,11 x Cj 105,60 x Pal	29,88 x Cj 1494 x Pal
Transition Profile / Perfil Transición / Profilé Jointoiment	4x270x1,3cm 1 5/8"x106 1/4"x1/2"	100086313 L164532095	G-161	10 x Cj 1000 x Pal	1,08 x Cj 108 x Pal	10,20 x Cj 1020 x Pal
Levelling Profile / Perfil Igualación / Profilé Egalisation	4,5x270x1,3cm 1 3/4"x106 1/4"x1/2"	100086309 L164705097	G-161	10 x Cj 1000 x Pal	1,08 x Cj 108 x Pal	10,20 x Cj 1020 x Pal
Stair Nosing / Mampelran / Nez de Marche	120x7x3cm 47 1/4"x2 3/4"x1 1/8"	100176544 L165003623	G-163	2 x Cj 200 x Pal	0,17 x Cj 16,80 x Pal	3,28 x Cj 327,80 x Pal

*Wood is a natural product, so consistency in length cannot be guaranteed. This range will be supplied in lengths of 240 or 210cm according to availability.

Debido a que la madera es un producto natural, no se puede asegurar el largo de esta serie y se servirá según disponibilidad indistintamente en 240 o 210cm.

Le bois étant un produit naturel, il est impossible de garantir la longueur de cette série et elle sera fournie en fonction des disponibilités aussi bien en 240 qu'en 210cm.

Due to better usage of the wood, any order of this reference may contain mean percentage tables of between 25% y 30% / Por un mejor aprovechamiento de la madera, cualquier pedido de esta referencia puede contener un porcentaje de medias tablas de entre 25% y 30% / Pour mieux mettre à profit le bois, toute commande portant sur cette référence peut contenir un pourcentage de demi-planches de 25% y 30%.



Floor Coverings Eden 1L Camel



Eden 1L Natural

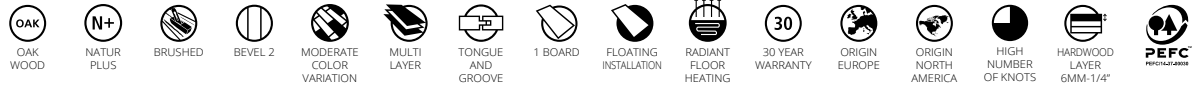

Description	Format	Codes	Group	Pcs	m2	Kg
Eden 1L Natural	20x240x2cm	100086067	G-263	4 x Cj	1,92 x Cj	23,04 x Cj
	7 7/8"x94 1/2"x3/4"	L160803253		160 x Pal	76,80 x Pal	921,60 x Pal
Eden 1L Natural	20x210x2cm	100190991	G-260	4 x Cj	1,68 x Cj	24,80 x Cj
	7 7/8"x82 5/8" x3/4"	L165003863		160 x Pal	67,20 x Pal	993,60 x Pal
Skirting / Zócalo / Plinthe	8x220x1,4cm	100086342	G-128	12 x Cj	2,11 x Cj	29,88 x Cj
Transition Profile / Perfil Transición / Profilé jointolement	4x270x1,3cm	100086330	G-161	10 x Cj	1,08 x Cj	10,20 x Cj
	1 5/8"x106 1/4"x1/2"	L164532097		1000 x Pal	108 x Pal	1020 x Pal
Levelling Profile / Perfil Igualación / Profilé Égalisation	4,5x270x1,3cm	100086322	G-161	10 x Cj	1,08 x Cj	10,20 x Cj
	1 3/4"x106 1/4"x1/2"	L164705098		1000 x Pal	108 x Pal	1020 x Pal
Stair Nosing / Mampierlan / Nez de Marche	120x7x3cm	100176546	G-163	2 x Cj	0,17 x Cj	3,28 x Cj
	47 1/4"x2 3/4"x1 1/8"	L165003633		200 x Pal	16,80 x Pal	327,80 x Pal

STOCK

*Wood is a natural product, so consistency in length cannot be guaranteed. This range will be supplied in lengths of 240 or 210cm according to availability.

Debido a que la madera es un producto natural, no se puede asegurar el largo de esta serie y se servirá según disponibilidad indistintamente en 240 o 210cm.

Le bois étant un produit naturel, il est impossible de garantir la longueur de cette série et elle sera fournie en fonction des disponibilités aussi bien en 240 qu'en 210cm.

Due to better usage of the wood, any order of this reference may contain mean percentage tables of between 25% y 30% / Por un mejor aprovechamiento de la madera, cualquier pedido de esta referencia puede contener un porcentaje de medias tablas de entre 25% y 30% / Pour mieux mettre à profit le bois, toute commande portant sur cette référence peut contenir un pourcentage de demi-planches de 25% y 30%.

Natural Wood



Eden 1L White



Description	Format	Codes	Group	Pcs	m2	Kg
Eden 1L White	20x240x2cm	100086068	G-263	4 x Cj	1,92 x Cj	23,04 x Cj
	7 7/8"x94 1/2"x3/4"	L160803252		160 x Pal	76,80 x Pal	921,60 x Pal
Eden 1L White	20x210x2cm	100188780	G-260	4 x Cj	1,68 x Cj	24,80 x Cj
	7 7/8"x82 5/8" x3/4"	L165003841		160 x Pal	67,20 x Pal	993,60 x Pal
Skirting / Zócalo / Plinthe	8x220x1,4cm	100086343	G-128	12 x Cj	2,11 x Cj	29,88 x Cj
Transition Profile / Perfil Transición / Profilé jointolement	4x270x1,3cm	100086332	G-161	10 x Cj	1,08 x Cj	10,20 x Cj
	1 5/8"x106 1/4"x1/2"	L164532096		1000 x Pal	108 x Pal	1020 x Pal
Levelling Profile / Perfil Igualación / Profilé Égalisation	4,5x270x1,3cm	100086324	G-161	10 x Cj	1,08 x Cj	10,20 x Cj
	1 3/4"x106 1/4"x1/2"	L164705099		1000 x Pal	108 x Pal	1020 x Pal
Stair Nosing / Mampierlan / Nez de Marche	120x7x3cm	100176569	G-163	2 x Cj	0,17 x Cj	3,28 x Cj
	47 1/4"x2 3/4"x1 1/8"	L165003631		200 x Pal	16,80 x Pal	327,80 x Pal

STOCK

*Wood is a natural product, so consistency in length cannot be guaranteed. This range will be supplied in lengths of 240 or 210cm according to availability.

Debido a que la madera es un producto natural, no se puede asegurar el largo de esta serie y se servirá según disponibilidad indistintamente en 240 o 210cm.

Le bois étant un produit naturel, il est impossible de garantir la longueur de cette série et elle sera fournie en fonction des disponibilités aussi bien en 240 qu'en 210cm.

Due to better usage of the wood, any order of this reference may contain mean percentage tables of between 25% y 30% / Por un mejor aprovechamiento de la madera, cualquier pedido de esta referencia puede contener un porcentaje de medias tablas de entre 25% y 30% / Pour mieux mettre à profit le bois, toute commande portant sur cette référence peut contenir un pourcentage de demi-planches de 25% y 30%.

Eden



Eden 1L Sand



Description	Format	Codes	Group	Pcs	m2	Kg
Eden 1L Sand	20x240x2cm	100095587	G-263	4 x Cj	1,92 x Cj	23,04 x Cj
	7 7/8"x94 1/2"x3/4"	L160803270		160 x Pal	76,80 x Pal	921,60 x Pal
Eden 1L Sand	20x210x2cm	100188758	G-260	4 x Cj	1,68 x Cj	24,80 x Cj
	7 7/8"x82 5/8"x3/4"	L165003839		160 x Pal	67,20 x Pal	993,60 x Pal
Skirting / Zócalo / Plinthe	8x220x1,4cm	100097175	G-128	12 x Cj	2,11 x Cj	29,88 x Cj
Transition Profile / Perfil Transición / Profilé Jointolement	4x270x1,3cm	100096093	G-161	10 x Cj	1,08 x Cj	10,20 x Cj
	1 5/8"x106 1/4"x1/2"	L164532151		1000 x Pal	108 x Pal	1020 x Pal
Levelling Profile / Perfil Igualación / Profilé Égalisation	4,5x270x1,3cm	100096098	G-161	10 x Cj	1,08 x Cj	10,20 x Cj
	1 3/4"x106 1/4"x1/2"	L164705104		1000 x Pal	108 x Pal	1020 x Pal
Stair Nosing / Mampelran / Nez de Marche	120x7x3cm	100176547	G-163	2 x Cj	0,17 x Cj	3,28 x Cj
	47 1/4"x2 3/4"x1 1/8"	L165003634		200 x Pal	16,80 x Pal	327,80 x Pal

*Wood is a natural product, so consistency in length cannot be guaranteed. This range will be supplied in lengths of 240 or 210cm according to availability.

Debido a que la madera es un producto natural, no se puede asegurar el largo de esta serie y se servirá según disponibilidad indistintamente en 240 o 210cm.

Le bois étant un produit naturel, il est impossible de garantir la longueur de cette série et elle sera fournie en fonction des disponibilités aussi bien en 240 qu'en 210cm.

Due to better usage of the wood, any order of this reference may contain mean percentage tables of between 25% y 30% / Por un mejor aprovechamiento de la madera, cualquier pedido de esta referencia puede contener un porcentaje de medias tablas de entre 25% y 30% / Pour mieux mettre à profit le bois, toute commande portant sur cette référence peut contenir un pourcentage de demi-planchettes de 25% y 30%.



Floor Coverings Eden 1L Natural



Edén 1L Venice



Description	Format	Codes	Group	Pcs	m2	Kg
Edén 1L Venice	20x180x2cm	100185668	G-272	4 x Cj	1,44 x Cj	20,37x Cj
	7 7/8"x70 7/8"x3/4"	L165003815		160 x Pal	57,60 x Pal	814,72 x Pal
White Skirting / Zócalo Parquet Blanco / Plinthe Parquet Blanc	8x220x1,5cm	100115023	G-128	14 x Cj	2,46 x Cj	30,45 x Cj
	3 1/8"x86 5/8"x5/8"	L165002603		560 x Pal	98,56 x Pal	1218 x Pal
Aluminium Levelling Profile / Perfil Igualación	4,5x270x1,3cm	100031458	G-161	10 x Cj	1,21 x Cj	10,20 x Cj
Aluminio / Profilé égalisation Aluminium	1 3/4"x106 1/4"x1/2"	L164705091		1000 x Pal	121,50 x Pal	1020 x Pal
Aluminium Transition Profile / Perfil Transición	4x270x1,3cm	100049265	G-161	10 x Cj	1,08 x Cj	11 x Cj
Aluminio / Profilé jointoiement Aluminium	1 5/8"x106 1/4"x1/2"	L164531141		1000 x Pal	107,99 x Pal	1100 x Pal

Due to better usage of the wood, any order of this reference may contain mean percentage tables of between 25% y 30% / Por un mejor aprovechamiento de la madera, cualquier pedido de esta referencia puede contener un porcentaje de medias tablas de entre 25% y 30% / Pour mieux mettre à profit le bois, toute commande portant sur cette référence peut contenir un pourcentage de demi-planches de 25% y 30%.

Natural Wood



Edén 1L Laguna



Description	Format	Codes	Group	Pcs	m2	Kg
Edén 1L Laguna	20x180x2cm	100185702	G-272	4 x Cj	1,44 x Cj	20,37x Cj
	7 7/8"x70 7/8"x3/4"	L165003813		160 x Pal	57,60 x Pal	814,72 x Pal
White Skirting / Zócalo Parquet Blanco / Plinthe Parquet Blanc	8x220x1,5cm	100115023	G-128	14 x Cj	2,46 x Cj	30,45 x Cj
	3 1/8"x86 5/8"x5/8"	L165002603		560 x Pal	98,56 x Pal	1218 x Pal
Aluminium Levelling Profile / Perfil Igualación	4,5x270x1,3cm	100031458	G-161	10 x Cj	1,21 x Cj	10,20 x Cj
Aluminio / Profilé égalisation Aluminium	1 3/4"x106 1/4"x1/2"	L164705091		1000 x Pal	121,50 x Pal	1020 x Pal
Aluminium Transition Profile / Perfil Transición	4x270x1,3cm	100049265	G-161	10 x Cj	1,08 x Cj	11 x Cj
Aluminio / Profilé jointoiement Aluminium	1 5/8"x106 1/4"x1/2"	L164531141		1000 x Pal	107,99 x Pal	1100 x Pal

Due to better usage of the wood, any order of this reference may contain mean percentage tables of between 25% y 30% / Por un mejor aprovechamiento de la madera, cualquier pedido de esta referencia puede contener un porcentaje de medias tablas de entre 25% y 30% / Pour mieux mettre à profit le bois, toute commande portant sur cette référence peut contenir un pourcentage de demi-planches de 25% y 30%.

Eden



Eden 1L Marengo

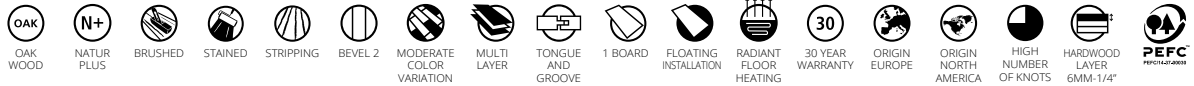

Description	Format	Codes	Group	Pcs	m2	Kg
Eden 1L Marengo	20x240x2cm 7 7/8"x94 1/2"x3/4"	100095586 L160803271	G-263	4 x Cj 160 x Pal	1,92 x Cj 76,80 x Pal	23,04 x Cj 921,60 x Pal
Eden 1L Marengo	20x210x2cm 7 7/8"x82 5/8" x3/4"	100189107 L165003843	G-260	4 x Cj 160 x Pal	1,68 x Cj 67,20 x Pal	24,80 x Cj 993,60 x Pal
Skirting / Zócalo / Plinthe	8x220x1,4cm 3 1/8"x86 5/8"x9/16"	100097173 L168001719	G-128	12 x Cj 600 x Pal	2,11 x Cj 105,60 x Pal	29,88 x Cj 1494 x Pal
Transition Profile / Perfil Transición / Profilé Jointoiment	4x270x1,3cm 1 5/8"x106 1/4"x1/2"	100096092 L164532150	G-161	10 x Cj 1000 x Pal	1,08 x Cj 108 x Pal	10,20 x Cj 1020 x Pal
Levelling Profile / Perfil Igualación / Profilé Egalisation	4,5x270x1,3cm 1 3/4"x106 1/4"x1/2"	100096097 L164705105	G-161	10 x Cj 1000 x Pal	1,08 x Cj 108 x Pal	10,20 x Cj 1020 x Pal
Stair Nosing / Mampferlan / Nez de Marche	120x7x3cm 47 1/4"x2 3/4"x1 1/8"	100176545 L165003635	G-163	2 x Cj 200 x Pal	0,17 x Cj 16,80 x Pal	3,28 x Cj 327,80 x Pal

*Wood is a natural product, so consistency in length cannot be guaranteed. This range will be supplied in lengths of 240 or 210cm according to availability.

Debido a que la madera es un producto natural, no se puede asegurar el largo de esta serie y se servirá según disponibilidad indistintamente en 240 o 210cm.

Le bois étant un produit naturel, il est impossible de garantir la longueur de cette série et elle sera fournie en fonction des disponibilités aussi bien en 240 qu'en 210cm.

Due to better usage of the wood, any order of this reference may contain mean percentage tables of between 25% y 30% / Por un mejor aprovechamiento de la madera, cualquier pedido de esta referencia puede contener un porcentaje de medias tablas de entre 25% y 30% / Pour mieux mettre à profilé le bois, toute commande portant sur cette référence peut contenir un pourcentage de demi-planches de 25% y 30%.



Floor Coverings Eden 1L Venice



Natural Wood

The image shows two white chairs with patterned seats on a wooden floor. The chairs are positioned in the upper right corner of the frame. The floor is made of light-colored wood with a visible grain pattern. The background is a plain white wall.

Mini Eden

Camel
Natural
White
Sand
Marengo
Brown
Light Grey
Dark Grey
Wenge

Natural Wood



Mini Eden 1L Camel



Description	Format	Codes	Group	Pcs	m2	Kg
Mini Eden 1L Camel	19x240x1,2cm	100130053	G-249	6 x Cj	2,74 x Cj	23,25 x Cj
	7 1/2"x94 1/2"x1/2"	L165002760		288 x Pal	131,33 x Pal	1116,29 x Pal
Mini Eden 1L Camel	19x210x1,2cm	100191425	G-246	6 x Cj	2,39 x Cj	22,20 x Cj
	7 1/2"x82 5/8"x1/2"	L165003872		300 x Pal	119,70 x Pal	1110 x Pal
Skirting / Zócalo / Plinthe	8x220x1,4cm	100129059	G-128	12 x Cj	2,11 x Cj	31,22 x Cj
Transition Profile / Perfil Transición / Profilé jointoement	4x270x1,3cm	100129049	G-161	10 x Cj	1,08 x Cj	10,20 x Cj
	1 5/8"x106 1/4"x1/2"	L165002701		1000 x Pal	108 x Pal	1020 x Pal
Levelling Profile / Perfil Igualación / Profilé Égalisation	4,5x270x1,3cm	100129029	G-161	10 x Cj	1,08 x Cj	10,20 x Cj
	1 3/4"x106 1/4"x1/2"	L165002716		1000 x Pal	108 x Pal	1020 x Pal
Stair Nosing / Mampierlan / Nez de Marche	120x7x3cm	100176581	G-163	2 x Cj	0,17 x Cj	3,28 x Cj
	47 1/4"x2 3/4"x1 1/8"	L165003640		200 x Pal	16,80 x Pal	327,80 x Pal

STOCK

*Wood is a natural product, so consistency in length cannot be guaranteed. This range will be supplied in lengths of 240 or 210cm according to availability.

Debido a que la madera es un producto natural, no se puede asegurar el largo de esta serie y se servirá según disponibilidad indistintamente en 240 o 210cm.

Le bois étant un produit naturel, il est impossible de garantir la longueur de cette série et elle sera fournie en fonction des disponibilités aussi bien en 240 qu'en 210cm.

Due to better usage of the wood, any order of this reference may contain mean percentage tables of between 30% y 35% / Por un mejor aprovechamiento de la madera, cualquier pedido de esta referencia puede contener un porcentaje de medias tablas de entre 30% y 35% / Pour mieux mettre à profit le bois, toute commande portant sur cette référence peut contenir un pourcentage de demi-planches 30% y 35%.

Natural Wood



Mini Eden 1L Natural

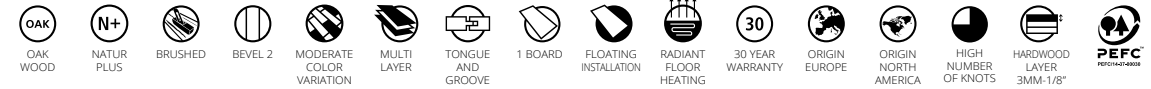

Description	Format	Codes	Group	Pcs	m2	Kg
Mini Eden 1L Natural	19x240x1,2cm	100130055	G-249	6 x Cj	2,74 x Cj	23,25 x Cj
	7 1/2"x94 1/2"x1/2"	L165002754		288 x Pal	131,33 x Pal	1116,29 x Pal
Mini Eden 1L Natural	19x210x1,2cm	100188025	G-246	6 x Cj	2,39 x Cj	22,20 x Cj
	7 1/2"x82 5/8"x1/2"	L165003832		300 x Pal	119,70 x Pal	1110 x Pal
Skirting / Zócalo / Plinthe	8x220x1,4cm	100129061	G-128	12 x Cj	2,11 x Cj	31,22 x Cj
Transition Profile / Perfil Transición / Profilé jointoement	4x270x1,3cm	100129051	G-161	10 x Cj	1,08 x Cj	10,20 x Cj
	1 5/8"x106 1/4"x1/2"	L165002706		1000 x Pal	108 x Pal	1020 x Pal
Levelling Profile / Perfil Igualación / Profilé Égalisation	4,5x270x1,3cm	100129031	G-161	10 x Cj	1,08 x Cj	10,20 x Cj
	1 3/4"x106 1/4"x1/2"	L165002707		1000 x Pal	108 x Pal	1020 x Pal
Stair Nosing / Mampierlan / Nez de Marche	120x7x3cm	100176594	G-163	2 x Cj	0,17 x Cj	3,28 x Cj
	47 1/4"x2 3/4"x1 1/8"	L165003644		200 x Pal	16,80 x Pal	327,80 x Pal

STOCK

*Wood is a natural product, so consistency in length cannot be guaranteed. This range will be supplied in lengths of 240 or 210cm according to availability.

Debido a que la madera es un producto natural, no se puede asegurar el largo de esta serie y se servirá según disponibilidad indistintamente en 240 o 210cm.

Le bois étant un produit naturel, il est impossible de garantir la longueur de cette série et elle sera fournie en fonction des disponibilités aussi bien en 240 qu'en 210cm.

Due to better usage of the wood, any order of this reference may contain mean percentage tables of between 30% y 35% / Por un mejor aprovechamiento de la madera, cualquier pedido de esta referencia puede contener un porcentaje de medias tablas de entre 30% y 35% / Pour mieux mettre à profit le bois, toute commande portant sur cette référence peut contenir un pourcentage de demi-planches 30% y 35%.

Mini Eden



Mini Eden 1L White



Description	Format	Codes	Group	Pcs	m2	Kg
Mini Eden 1L White	19x240x1,2cm	100130056	G-249	6 x Cj	2,74 x Cj	23,25 x Cj
	7 1/2"x94 1/2"x1/2"	L165002755		288 x Pal	131,33 x Pal	1116,29 x Pal
Mini Eden 1L White	19x210x1,2cm	100187566	G-246	6 x Cj	2,39 x Cj	22,20 x Cj
	7 1/2"x82 5/8"x1/2"	L165003829		300 x Pal	119,70 x Pal	1110 x Pal
Skirting / Zócalo / Plinthe	8x220x1,4cm	100129062	G-128	12 x Cj	2,11 x Cj	31,22 x Cj
	3 1/8"x86 5/8"x9/16"	L165002702		600 x Pal	105,60 x Pal	1561,20 x Pal
Transition Profile / Perfil Transición / Profilé Jointoierment	4x270x1,3cm	100129052	G-161	10 x Cj	1,08 x Cj	10,20 x Cj
	1 5/8"x106 1/4"x1/2"	L165002726		1000 x Pal	108 x Pal	1020 x Pal
Levelling Profile / Perfil Igualación / Profilé Égalisation	4,5x270x1,3cm	100129032	G-161	10 x Cj	1,08 x Cj	10,20 x Cj
	1 3/4"x106 1/4"x1/2"	L165002731		1000 x Pal	108 x Pal	1020 x Pal
Stair Nosing / Mampferlan / Nez de Marche	120x7x3cm	100176601	G-163	2 x Cj	0,17 x Cj	3,28 x Cj
	47 1/4"x2 3/4"x1 1/8"	L165003661		200 x Pal	16,80 x Pal	327,80 x Pal

STOCK

*Wood is a natural product, so consistency in length cannot be guaranteed. This range will be supplied in lengths of 240 or 210cm according to availability.

Debido a que la madera es un producto natural, no se puede asegurar el largo de esta serie y se servirá según disponibilidad indistintamente en 240 o 210cm.

Le bois étant un produit naturel, il est impossible de garantir la longueur de cette série et elle sera fournie en fonction des disponibilités aussi bien en 240 qu'en 210cm.

Due to better usage of the wood, any order of this reference may contain mean percentage tables of between 30% y 35% / Por un mejor aprovechamiento de la madera, cualquier pedido de esta referencia puede contener un porcentaje de medias tablas de entre 30% y 35% / Pour mieux mettre à profilé le bois, toute commande portant sur cette référence peut contenir un pourcentage de demi-planches 30% y 35%.



Floor Coverings Mini Eden 1L Natural / Wall Coverings Wood Wall Bronze



Mini Eden 1L Sand



Description	Format	Codes	Group	Pcs	m2	Kg
Mini Eden 1L Sand	19x240x1,2cm	100136449	G-249	6 x Cj	2,73 x Cj	23,25 x Cj
	7 1/2"x94 1/2"x1/2"	L165002833		300 x Pal	136,80 x Pal	1116,29 x Pal
Mini Eden 1L Sand	19x210x1,2cm	100188304	G-246	6 x Cj	2,39 x Cj	22,20 x Cj
	7 1/2"x82 5/8"x1/2"	L165003835		300 x Pal	119,70 x Pal	1110 x Pal
Skirting / Zócalo / Plinthe	8x220x1,4cm	100136995	G-128	12 x Cj	2,11 x Cj	16,56 x Cj
	3 1/8"x86 5/8"x9/16"	L165002838		600 x Pal	105,60 x Pal	828 x Pal
Transition Profile / Perfil Transición / Profilé Jointolement	4x270x1,3cm	100143507	G-161	10 x Cj	1,08 x Cj	10,20 x Cj
	1 5/8"x106 1/4"x1/2"	L165002971		1000 x Pal	108 x Pal	1020 x Pal
Levelling Profile / Perfil Igualación / Profilé Égalisation	4,5x270x1,3cm	100143512	G-161	10 x Cj	1,21 x Cj	10,20 x Cj
	1 3/4"x106 1/4"x1/2"	L165002976		1000 x Pal	121,50 x Pal	1020 x Pal
Stair Nosing / Mampierlan / Nez de Marche	120x7x3cm	100176600	G-163	2 x Cj	0,17 x Cj	3,28 x Cj
	47 1/4"x2 3/4"x1 1/8"	L165003647		200 x Pal	16,80 x Pal	327,80 x Pal

*Wood is a natural product, so consistency in length cannot be guaranteed. This range will be supplied in lengths of 240 or 210cm according to availability.

Debido a que la madera es un producto natural, no se puede asegurar el largo de esta serie y se servirá según disponibilidad indistintamente en 240 o 210cm.

Le bois étant un produit naturel, il est impossible de garantir la longueur de cette série et elle sera fournie en fonction des disponibilités aussi bien en 240 qu'en 210cm.

Due to better usage of the wood, any order of this reference may contain mean percentage tables of between 30% y 35% / Por un mejor aprovechamiento de la madera, cualquier pedido de esta referencia puede contener un porcentaje de medias tablas de entre 30% y 35% / Pour mieux mettre à profit le bois, toute commande portant sur cette référence peut contenir un pourcentage de demi-planches 30% y 35%.

Natural Wood



Mini Eden 1L Marengo



Description	Format	Codes	Group	Pcs	m2	Kg
Mini Eden 1L Marengo	19x240x1,2cm	100130054	G-249	6 x Cj	2,74 x Cj	23,25 x Cj
	7 1/2"x94 1/2"x1/2"	L165002759		288 x Pal	131,33 x Pal	1116,29 x Pal
Mini Eden 1L Marengo	19x210x1,2cm	100191435	G-246	6 x Cj	2,39 x Cj	22,20 x Cj
	7 1/2"x82 5/8"x1/2"	L165003885		300 x Pal	119,70 x Pal	1110 x Pal
Skirting / Zócalo / Plinthe	8x220x1,4cm	100129060	G-128	12 x Cj	2,11 x Cj	31,22 x Cj
	3 1/8"x86 5/8"x9/16"	L165002734		600 x Pal	105,60 x Pal	1561,20 x Pal
Transition Profile / Perfil Transición / Profilé Jointolement	4x270x1,3cm	100129050	G-161	10 x Cj	1,08 x Cj	10,20 x Cj
	1 5/8"x106 1/4"x1/2"	L165002739		1000 x Pal	108 x Pal	1020 x Pal
Levelling Profile / Perfil Igualación / Profilé Égalisation	4,5x270x1,3cm	100129030	G-161	10 x Cj	1,08 x Cj	10,20 x Cj
	1 3/4"x106 1/4"x1/2"	L165002723		1000 x Pal	108 x Pal	1020 x Pal
Stair Nosing / Mampierlan / Nez de Marche	120x7x3cm	100176582	G-163	2 x Cj	0,17 x Cj	3,28 x Cj
	47 1/4"x2 3/4"x1 1/8"	L165003642		200 x Pal	16,80 x Pal	327,80 x Pal

*Wood is a natural product, so consistency in length cannot be guaranteed. This range will be supplied in lengths of 240 or 210cm according to availability.

Debido a que la madera es un producto natural, no se puede asegurar el largo de esta serie y se servirá según disponibilidad indistintamente en 240 o 210cm.

Le bois étant un produit naturel, il est impossible de garantir la longueur de cette série et elle sera fournie en fonction des disponibilités aussi bien en 240 qu'en 210cm.

Due to better usage of the wood, any order of this reference may contain mean percentage tables of between 30% y 35% / Por un mejor aprovechamiento de la madera, cualquier pedido de esta referencia puede contener un porcentaje de medias tablas de entre 30% y 35% / Pour mieux mettre à profit le bois, toute commande portant sur cette référence peut contenir un pourcentage de demi-planches 30% y 35%.

Mini Eden



Mini Eden 1L Brown



Description	Format	Codes	Group	Pcs	m2	Kg
Mini Eden 1L Brown	19x240x1,2cm	100130052	G-249	6 x Cj	2,74 x Cj	23,25 x Cj
	7 1/2"x94 1/2"x1/2"	L165002758		288 x Pal	131,33 x Pal	1116,29 x Pal
Mini Eden 1L Brown	19x210x1,2cm	100189366	G-246	6 x Cj	2,39 x Cj	22,20 x Cj
	7 1/2"x82 5/8"x1/2"	L165003851		300 x Pal	119,70 x Pal	1110 x Pal
Skirting / Zócalo / Plinthe	8x220x1,4cm	100129058	G-128	12 x Cj	2,11 x Cj	31,22 x Cj
	3 1/8"x86 5/8"x9/16"	L165002713		600 x Pal	105,60 x Pal	1561,20 x Pal
Transition Profile / Perfil Transición / Profilé Jointoiment	4x270x1,3cm	100129048	G-161	10 x Cj	1,08 x Cj	10,20 x Cj
	1 5/8"x106 1/4"x1/2"	L165002718		1000 x Pal	108 x Pal	1020 x Pal
Levelling Profile / Perfil Igualación / Profilé Egalisation	4,5x270x1,3cm	100129028	G-161	10 x Cj	1,08 x Cj	10,20 x Cj
	1 3/4"x106 1/4"x1/2"	L165002719		1000 x Pal	108 x Pal	1020 x Pal
Stair Nosing / Mampferlan / Nez de Marche	120x7x3cm	100176593	G-163	2 x Cj	0,17 x Cj	3,28 x Cj
	47 1/4"x2 3/4"x1 1/8"	L165003639		200 x Pal	16,80 x Pal	327,80 x Pal

• STOCK

*Wood is a natural product, so consistency in length cannot be guaranteed. This range will be supplied in lengths of 240 or 210cm according to availability.

Debido a que la madera es un producto natural, no se puede asegurar el largo de esta serie y se servirá según disponibilidad indistintamente en 240 o 210cm.

Le bois étant un produit naturel, il est impossible de garantir la longueur de cette série et elle sera fournie en fonction des disponibilités aussi bien en 240 qu'en 210cm.

Due to better usage of the wood, any order of this reference may contain mean percentage tables of between 30% y 35% / Por un mejor aprovechamiento de la madera, cualquier pedido de esta referencia puede contener un porcentaje de medias tablas de entre 30% y 35% / Pour mieux mettre à profit le bois, toute commande portant sur cette référence peut contenir un pourcentage de demi-planches 30% y 35%.



Floor Coverings Mini Eden 1L Brown

The use of natural wood in baths shall be the responsibility of the client. / El uso de la madera natural en baños es bajo la responsabilidad del cliente. / Il est de la responsabilité du client l'utilisation du bois naturel dans les bains

Natural Wood



Mini Eden 1L
Light Grey



Description	Format	Codes	Group	Pcs	m2	Kg
Mini Eden 1L Light Grey	19x240x1,2cm 7 1/2"x94 1/2"x1/2"	100151225 L165003073	G-249	6 x Cj 300 x Pal	2,73 x Cj 136,80 x Pal	23,25 x Cj 1116,29 x Pal
Mini Eden 1L Light Grey	19x210x1,2cm 7 1/2"x82 5/8"x1/2"	100189811 L165003859	G-246	6 x Cj 300 x Pal	2,39 x Cj 119,70 x Pal	22,20 x Cj 1110 x Pal
Skirting / Zócalo / Plinthe	8x220x1,4cm 3 1/8"x86 5/8"x9/16"	100152674 L165003083	G-128	12 x Cj 600 x Pal	2,11 x Cj 105,60 x Pal	16,56 x Cj 828 x Pal
Transition Profile / Perfil Transición / Profilé jointolement	4x270x1,3cm 1 5/8"x106 1/4"x1/2"	100152659 L165003078	G-161	10 x Cj 1000 x Pal	1,08 x Cj 108 x Pal	10,20 x Cj 1020 x Pal
Levelling Profile / Perfil Igualación / Profilé Égalisation	4,5x270x1,3cm 1 3/4"x106 1/4"x1/2"	100152672 L165003081	G-161	10 x Cj 1000 x Pal	1,08 x Cj 108 x Pal	10,20 x Cj 1020 x Pal
Stair Nosing / Mampierlan / Nez de Marche	120x7x3cm 47 1/4"x2 3/4"x1 1/8"	100176549 L165003645	G-163	2 x Cj 200 x Pal	0,17 x Cj 16,80 x Pal	3,28 x Cj 327,80 x Pal

*Wood is a natural product, so consistency in length cannot be guaranteed. This range will be supplied in lengths of 240 or 210cm according to availability.

Debido a que la madera es un producto natural, no se puede asegurar el largo de esta serie y se servirá según disponibilidad indistintamente en 240 o 210cm.

Le bois étant un produit naturel, il est impossible de garantir la longueur de cette série et elle sera fournie en fonction des disponibilités aussi bien en 240 qu'en 210cm.

Due to better usage of the wood, any order of this reference may contain mean percentage tables of between 30% y 35% / Por un mejor aprovechamiento de la madera, cualquier pedido de esta referencia puede contener un porcentaje de medias tablas de entre 30% y 35% / Pour mieux mettre à profit le bois, toute commande portant sur cette référence peut contenir un pourcentage de demi-planches 30% y 35%.

Natural Wood

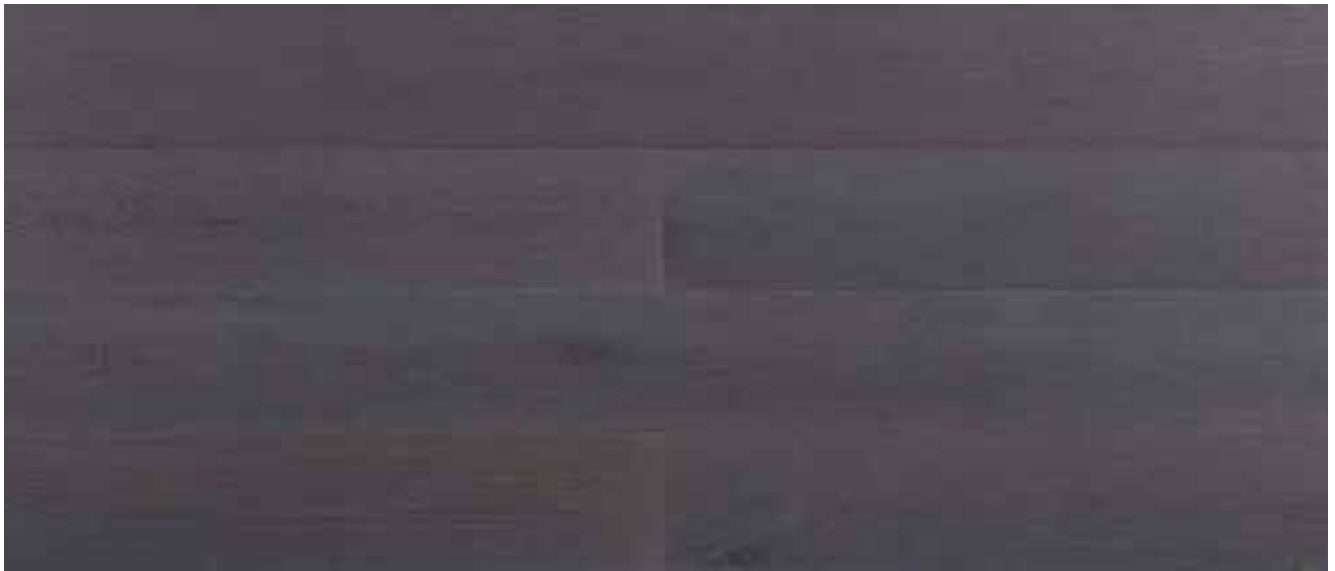

Mini Eden 1L
Dark Grey



Description	Format	Codes	Group	Pcs	m2	Kg
Mini Eden 1L Dark Grey	19x240x1,2cm 7 1/2"x94 1/2"x1/2"	100151224 L165003072	G-249	6 x Cj 300 x Pal	2,73 x Cj 136,80 x Pal	23,25 x Cj 1116,29 x Pal
Mini Eden 1L Dark Grey	19x210x1,2cm 7 1/2"x82 5/8"x1/2"	100191433 L165003880	G-246	6 x Cj 300 x Pal	2,39 x Cj 119,70 x Pal	22,39 x Cj 1110 x Pal
Skirting / Zócalo / Plinthe	8x220x1,4cm 3 1/8"x86 5/8"x9/16"	100154393 L165003173	G-128	12 x Cj 600 x Pal	2,11 x Cj 105,60 x Pal	16,56 x Cj 828 x Pal
Transition Profile / Perfil Transición / Profilé jointolement	4x270x1,3cm 1 5/8"x106 1/4"x1/2"	100154390 L165003171	G-161	10 x Cj 1000 x Pal	1,08 x Cj 108 x Pal	10,20 x Cj 1020 x Pal
Levelling Profile / Perfil Igualación / Profilé Égalisation	4,5x270x1,3cm 1 3/4"x106 1/4"x1/2"	100154392 L165003174	G-161	10 x Cj 1000 x Pal	1,08 x Cj 108 x Pal	10,20 x Cj 1020 x Pal
Stair Nosing / Mampierlan / Nez de Marche	120x7x3cm 47 1/4"x2 3/4"x1 1/8"	100176575 L165003641	G-163	2 x Cj 200 x Pal	0,17 x Cj 16,80 x Pal	3,28 x Cj 327,80 x Pal

*Wood is a natural product, so consistency in length cannot be guaranteed. This range will be supplied in lengths of 240 or 210cm according to availability.

Debido a que la madera es un producto natural, no se puede asegurar el largo de esta serie y se servirá según disponibilidad indistintamente en 240 o 210cm.

Le bois étant un produit naturel, il est impossible de garantir la longueur de cette série et elle sera fournie en fonction des disponibilités aussi bien en 240 qu'en 210cm.

Due to better usage of the wood, any order of this reference may contain mean percentage tables of between 30% y 35% / Por un mejor aprovechamiento de la madera, cualquier pedido de esta referencia puede contener un porcentaje de medias tablas de entre 30% y 35% / Pour mieux mettre à profit le bois, toute commande portant sur cette référence peut contenir un pourcentage de demi-planches 30% y 35%.

Mini Eden



Mini Eden 1L Wenge



Description	Format	Codes	Group	Pcs	m2	Kg
Mini Eden 1L Wenge	19x240x1,2cm	100136460	G-249	6 x Cj	2,73 x Cj	23,25 x Cj
	7 1/2"x94 1/2"x1/2"	L165002834		300 x Pal	136,80 x Pal	1116,29 x Pal
Mini Eden 1L Wenge	19x210x1,2cm	100189511	G-246	6 x Cj	2,39 x Cj	22,20 x Cj
	7 1/2"x82 5/8"x1/2"	L165003855		300 x Pal	119,70 x Pal	1110 x Pal
Skirting / Zócalo / Plinthe	8x220x1,4cm	100136996	G-128	12 x Cj	2,11 x Cj	16,56 x Cj
	3 1/8"x86 5/8"x9/16"	L165002839		600 x Pal	105,60 x Pal	828 x Pal
Transition Profile / Perfil Transición / Profilé Jointoierment	4x270x1,3cm	100143513	G-161	10 x Cj	1,08 x Cj	10,20 x Cj
	1 5/8"x106 1/4"x1/2"	L165002977		1000 x Pal	108 x Pal	1020 x Pal
Levelling Profile / Perfil Igualación / Profilé Egalisation	4,5x270x1,3cm	100143508	G-161	10 x Cj	1,08 x Cj	10,20 x Cj
	1 3/4"x106 1/4"x1/2"	L165002969		1000 x Pal	108 x Pal	1020 x Pal
Stair Nosing / Mampferlan / Nez de Marche	120x7x3cm	100176583	G-163	2 x Cj	0,17 x Cj	3,28 x Cj
	47 1/4"x2 3/4"x1 1/8"	L165003648		200 x Pal	16,80 x Pal	327,80 x Pal

*Wood is a natural product, so consistency in length cannot be guaranteed. This range will be supplied in lengths of 240 or 210cm according to availability.

Debido a que la madera es un producto natural, no se puede asegurar el largo de esta serie y se servirá según disponibilidad indistintamente en 240 o 210cm.

Le bois étant un produit naturel, il est impossible de garantir la longueur de cette série et elle sera fournie en fonction des disponibilités aussi bien en 240 qu'en 210cm.

Due to better usage of the wood, any order of this reference may contain mean percentage tables of between 30% y 35% / Por un mejor aprovechamiento de la madera, cualquier pedido de esta referencia puede contener un porcentaje de medias tablas de entre 30% y 35% / Pour mieux mettre à profilé le bois, toute commande portant sur cette référence peut contenir un pourcentage de demi-planches 30% y 35%.



Floor Coverings Mini Eden 1L Wenge

Eden Texture

—
Almond
Cinamon
Nut



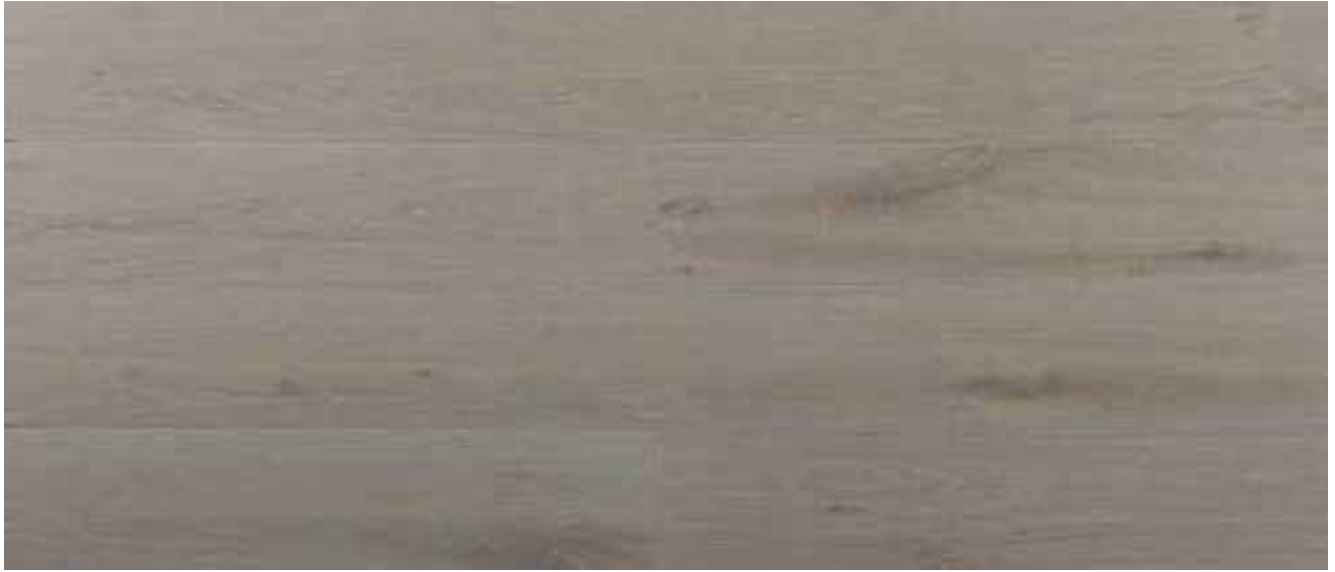

Eden Texture 1L Almond



Description	Format	Codes	Group	Pcs	m2	Kg
Eden Texture 1L Almond	20x240x2cm 7 7/8"x94 1/2"x3/4"	100130057 L165002753	G-267	4 x Cj 160 x Pal	1,92 x Cj 76,80 x Pal	23,04 x Cj 921,60 x Pal
Eden Texture 1L Almond	20x210x2cm 7 7/8"x82 5/8" x3/4"	100191413 L165003875	G-265	4 x Cj 160 x Pal	1,68 x Cj 67,20 x Pal	24,84 x Cj 993,60 x Pal
Skirting / Zócalo / Plinthe	8x220x1,4cm 3 1/8"x86 5/8"x9/16"	100130634 L165002801	G-128	12 x Cj 600 x Pal	2,11 x Cj 105,60 x Pal	31,22 x Cj 1561,20 x Pal
Transition Profile / Perfil Transición / Profilé jointolement	4x270x1,3cm 1 5/8"x106 1/4"x1/2"	100130629 L165002811	G-161	10 x Cj 1000 x Pal	1,08 x Cj 108 x Pal	10,20 x Cj 1020 x Pal
Levelling Profile / Perfil Igualación / Profilé Égalisation	4,5x270x1,3cm 1 3/4"x106 1/4"x1/2"	100130619 L165002806	G-161	10 x Cj 1000 x Pal	1,08 x Cj 108 x Pal	10,20 x Cj 1020 x Pal
Stair Nosing / Mampierlan / Nez de Marche	120x7x3cm 47 1/4"x2 3/4"x1 1/8"	100176590 L165003628	G-163	2 x Cj 200 x Pal	0,17 x Cj 16,80 x Pal	3,28 x Cj 327,80 x Pal

*Wood is a natural product, so consistency in length cannot be guaranteed. This range will be supplied in lengths of 240 or 210cm according to availability.

Debido a que la madera es un producto natural, no se puede asegurar el largo de esta serie y se servirá según disponibilidad indistintamente en 240 o 210cm.

Le bois étant un produit naturel, il est impossible de garantir la longueur de cette série et elle sera fournie en fonction des disponibilités aussi bien en 240 qu'en 210cm.

Due to better usage of the wood, any order of this reference may contain mean percentage tables of between 25% y 30% / Por un mejor aprovechamiento de la madera, cualquier pedido de esta referencia puede contener un porcentaje de medias tablas de entre 25% y 30% / Pour mieux mettre à profit le bois, toute commande portant sur cette référence peut contenir un pourcentage de demi-planches 25% y 30%.

Natural Wood



Eden Texture 1L Cinamon



Description	Format	Codes	Group	Pcs	m2	Kg
Eden Texture 1L Cinamon	20x240x2cm 7 7/8"x94 1/2"x3/4"	100130058 L165002757	G-267	4 x Cj 160 x Pal	1,92 x Cj 76,80 x Pal	23,04 x Cj 921,60 x Pal
Eden Texture 1L Cinamon	20x210x2cm 7 7/8"x82 5/8" x3/4"	100191272 L165003864	G-265	4 x Cj 160 x Pal	1,68 x Cj 67,20 x Pal	24,84 x Cj 993,60 x Pal
Skirting / Zócalo / Plinthe	8x220x1,4cm 3 1/8"x86 5/8"x9/16"	100130635 L165002810	G-128	12 x Cj 600 x Pal	2,11 x Cj 105,60 x Pal	31,22 x Cj 1561,20 x Pal
Transition Profile / Perfil Transición / Profilé jointolement	4x270x1,3cm 1 5/8"x106 1/4"x1/2"	100130630 L165002816	G-161	10 x Cj 1000 x Pal	1,08 x Cj 108 x Pal	10,20 x Cj 1020 x Pal
Levelling Profile / Perfil Igualación / Profilé Égalisation	4,5x270x1,3cm 1 3/4"x106 1/4"x1/2"	100130620 L165002800	G-161	10 x Cj 1000 x Pal	1,08 x Cj 108 x Pal	10,20 x Cj 1020 x Pal
Stair Nosing / Mampierlan / Nez de Marche	120x7x3cm 47 1/4"x2 3/4"x1 1/8"	100176573 L165003626	G-163	2 x Cj 200 x Pal	0,17 x Cj 16,80 x Pal	3,28 x Cj 327,80 x Pal

*Wood is a natural product, so consistency in length cannot be guaranteed. This range will be supplied in lengths of 240 or 210cm according to availability.

Debido a que la madera es un producto natural, no se puede asegurar el largo de esta serie y se servirá según disponibilidad indistintamente en 240 o 210cm.

Le bois étant un produit naturel, il est impossible de garantir la longueur de cette série et elle sera fournie en fonction des disponibilités aussi bien en 240 qu'en 210cm.

Due to better usage of the wood, any order of this reference may contain mean percentage tables of between 25% y 30% / Por un mejor aprovechamiento de la madera, cualquier pedido de esta referencia puede contener un porcentaje de medias tablas de entre 25% y 30% / Pour mieux mettre à profit le bois, toute commande portant sur cette référence peut contenir un pourcentage de demi-planches 25% y 30%.

Eden Texture



Eden Texture 1L Nut



Description	Format	Codes	Group	Pcs	m2	Kg
Eden Texture 1L Nut	20x240x2cm	100189354	G-267	4 x Cj	1,92 x Cj	28,40 x Cj
	7 7/8"x94 1/2"x3/4"	L165003850		160 x Pal	76,80 x Pal	1136 x Pal
Eden Texture 1L Nut	20x210x2cm	100189363	G-265	4 x Cj	1,68 x Cj	24,84 x Cj
	7 7/8"x82 5/8" x3/4"	L165003847		160 x Pal	67,20 x Pal	993,60 x Pal
Skirting / Zócalo / Plinthe	8x220x1,4cm	100130637	G-128	12 x Cj	2,11 x Cj	31,22 x Cj
	3 1/8"x86 5/8"x9/16"	L165002809		600 x Pal	105,60 x Pal	1561,20 x Pal
Transition Profile / Perfil Transición / Profilé Jointoiment	4x270x1,3cm	100130632	G-161	10 x Cj	1,08 x Cj	10,20 x Cj
	1 5/8"x106 1/4"x1/2"	L165002817		1000 x Pal	108 x Pal	1020 x Pal
Levelling Profile / Perfil Igualación / Profilé Égalisation	4,5x270x1,3cm	100130622	G-161	10 x Cj	1,08 x Cj	10,20 x Cj
	1 3/4"x106 1/4"x1/2"	L165002812		1000 x Pal	108 x Pal	1020 x Pal
Stair Nosing / Mampferlan / Nez de Marche	120x7x3cm	100176548	G-163	2 x Cj	0,17 x Cj	3,28 x Cj
	47 1/4"x2 3/4"x1 1/8"	L165003636		200 x Pal	16,80 x Pal	327,80 x Pal

*Wood is a natural product, so consistency in length cannot be guaranteed. This range will be supplied in lengths of 240 or 210cm according to availability.

Debido a que la madera es un producto natural, no se puede asegurar el largo de esta serie y se servirá según disponibilidad indistintamente en 240 o 210cm.

Le bois étant un produit naturel, il est impossible de garantir la longueur de cette série et elle sera fournie en fonction des disponibilités aussi bien en 240 qu'en 210cm.

Due to better usage of the wood, any order of this reference may contain mean percentage tables of between 25% y 30% / Por un mejor aprovechamiento de la madera, cualquier pedido de esta referencia puede contener un porcentaje de medias tablas de entre 25% y 30% / Pour mieux mettre à profit le bois, toute commande portant sur cette référence peut contenir un pourcentage de demi-planches 25% y 30%.



Natural Wood

Floor Coverings Eden Texture1L Almond / **Wall Coverings** Persian White Classico / **Complementary Products** Menhir Bañera Persian White - Roble Natural

The use of natural wood in baths shall be the responsibility of the client. / El uso de la madera natural en baños es bajo la responsabilidad del cliente. / Il est de la responsabilité du client l'utilisation du bois naturel dans les bains





Mini Eden Texture

—
Almond
Cinamon
Nut

Natural Wood



Mini Eden Texture
1L Almond



Description	Format	Codes	Group	Pcs	m2	Kg
Mini Eden Texture 1L Almond	19x210x1,2cm 7 7/8"x82 5/8"x1/2"	100146039 L165002993	G-252	6 x Cj 300 x Pal	2,39 x Cj 119,70 x Pal	20,35 x Cj 1017,45 x Pal
Skirting / Zócalo / Plinthe	8x220x1,4cm 3 1/8"x86 5/8"x9/16"	100146547 L165003048	G-128	12 x Cj 600 x Pal	2,11 x Cj 105,60 x Pal	16,56 x Cj 828 x Pal
Transition Profile / Perfil Transición / Profilé Jointoiment	4x270x1,3cm 1 5/8"x106 1/4"x1/2"	100146579 L165003008	G-161	10 x Cj 1000 x Pal	1,08 x Cj 108 x Pal	10,20 x Cj 1020 x Pal
Levelling Profile / Perfil Igualación / Profilé Égalisation	4,5x270x1,3cm 1 3/4"x106 1/4"x1/2"	100146575 L165003012	G-161	10 x Cj 1000 x Pal	1,08 x Cj 108 x Pal	10,20 x Cj 1020 x Pal
Stair Nosing / Mampelian / Nez de Marche	120x7x3cm 47 1/4"x2 3/4"x1 1/8"	100176602 L165003658	G-163	2 x Cj 200 x Pal	0,17 x Cj 16,80 x Pal	3,28 x Cj 327,80 x Pal

STOCK

Due to better usage of the wood, any order of this reference may contain mean percentage tables of between 30% y 35%.

Por un mejor aprovechamiento de la madera, cualquier pedido de esta referencia puede contener un porcentaje de medias tablas de entre 30% y 35%.

Pour mieux mettre à profit le bois, toute commande portant sur cette référence peut contenir un pourcentage de demi-planches de 30% y 35%.

Natural Wood



Mini Eden Texture
1L Cinamon



Description	Format	Codes	Group	Pcs	m2	Kg
Mini Eden Texture 1L Cinamon	19x210x1,2cm 7 7/8"x82 5/8"x1/2"	100146120 L165002989	G-252	6 x Cj 300 x Pal	2,39 x Cj 119,70 x Pal	20,35 x Cj 1017,45 x Pal
Skirting / Zócalo / Plinthe	8x220x1,4cm 3 1/8"x86 5/8"x9/16"	100146548 L165003058	G-128	12 x Cj 600 x Pal	2,11 x Cj 105,60 x Pal	16,56 x Cj 828 x Pal
Transition Profile / Perfil Transición / Profilé Jointoiment	4x270x1,3cm 1 5/8"x106 1/4"x1/2"	100146537 L165003015	G-161	10 x Cj 1000 x Pal	1,08 x Cj 108 x Pal	10,20 x Cj 1020 x Pal
Levelling Profile / Perfil Igualación / Profilé Égalisation	4,5x270x1,3cm 1 3/4"x106 1/4"x1/2"	100146590 L165003007	G-161	10 x Cj 1000 x Pal	1,08 x Cj 108 x Pal	10,20 x Cj 1020 x Pal
Stair Nosing / Mampelian / Nez de Marche	120x7x3cm 47 1/4"x2 3/4"x1 1/8"	100176596 L165003660	G-163	2 x Cj 200 x Pal	0,17 x Cj 16,80 x Pal	3,28 x Cj 327,80 x Pal

Due to better usage of the wood, any order of this reference may contain mean percentage tables of between 30% y 35%.

Por un mejor aprovechamiento de la madera, cualquier pedido de esta referencia puede contener un porcentaje de medias tablas de entre 30% y 35%.

Pour mieux mettre à profit le bois, toute commande portant sur cette référence peut contenir un pourcentage de demi-planches de 30% y 35%.

Mini Eden Texture



Mini Eden Texture 1L Nut



Description	Format	Codes	Group	Pcs	m2	Kg
Mini Eden Texture 1L Nut	19x210x1,2cm 7 7/8"x82 5/8"x1/2"	100189356 L165003849	G-252	6 x Cj 300 x Pal	2,39 x Cj 119,70 x Pal	22,20 x Cj 1110 x Pal
Skirting / Zócalo / Plinthe	8x220x1,4cm 3 1/8"x86 5/8"x9/16"	100146570 L165003056	G-128	12 x Cj 600 x Pal	2,11 x Cj 105,60 x Pal	16,56 x Cj 828 x Pal
Transition Profile / Perfil Transición / Profilé Jointoiement	4x270x1,3cm 1 5/8"x106 1/4"x1/2"	100146539 L165003019	G-161	10 x Cj 1000 x Pal	1,08 x Cj 108 x Pal	10,20 x Cj 1020 x Pal
Levelling Profile / Perfil Igualación / Profilé Egalisation	4,5x270x1,3cm 1 3/4"x106 1/4"x1/2"	100146592 L165003010	G-161	10 x Cj 1000 x Pal	1,08 x Cj 108 x Pal	10,20 x Cj 1020 x Pal
Stair Nosing / Mampelan / Nez de Marche	120x7x3cm 47 1/4"x2 3/4"x1 1/8"	100176603 L165003655	G-163	2 x Cj 200 x Pal	0,17 x Cj 16,80 x Pal	3,28 x Cj 327,80 x Pal

Due to better usage of the wood, any order of this reference may contain mean percentage tables of between 30% y 35%.

Por un mejor aprovechamiento de la madera, cualquier pedido de esta referencia puede contener un porcentaje de medias tablas de entre 30% y 35%.

Pour mieux mettre à profit le bois, toute commande portant sur cette référence peut contenir un pourcentage de demi-planches de 30% y 35%.



Floor & Ceiling Coverings Mini Eden Texture1L Almond / Wall Coverings Linkfloor Wall Contract Cotton, Airstate Kashmir

Legend

—
Neutral
Light





Legend 1L Neutral

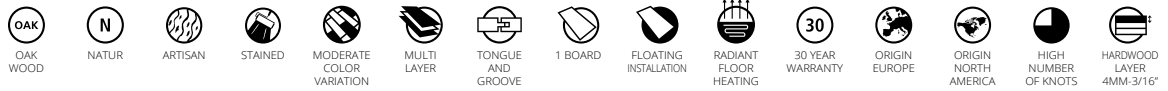

Description	Format	Codes	Group	Pcs	m2	Kg
Legend 1L Neutral	26x220x1,5cm 10 1/4"x86 5/8"x5/8"	100110287 L160803374	G-257	6 x Cj 168 x Pal	3,43 x Cj 96,10 x Pal	29,12 x Cj 815,47 x Pal
Skirting / Zócalo / Plinthe	8x220x1,4cm 3 1/8"x86 5/8"x1/2"	100114266 L165002540	G-128	12 x Cj 600 x Pal	2,11 x Cj 105,60 x Pal	16,56 x Cj 828 x Pal
Transition Profile / Perfil Transición / Profilé Jointoiment	4x270x1,3cm 1 5/8"x106 1/4"x1/2"	100114253 L165002519	G-161	10 x Cj 1000 x Pal	1,08 x Cj 108 x Pal	10,20 x Cj 1020 x Pal
Levelling Profile / Perfil Igualación / Profilé Égalisation	4,5x270x1,3cm 1 3/4"x106 1/4"x1/2"	100114237 L165002521	G-161	10 x Cj 1000 x Pal	1,08 x Cj 108 x Pal	10,20 x Cj 1020 x Pal
Stair Nosing / Mampelian / Nez de Marche	120x7x3cm 47 1/4"x2 3/4"x1 1/8"	100176592 L165003638	G-163	2 x Cj 200 x Pal	0,17 x Cj 16,80 x Pal	3,28 x Cj 327,80 x Pal

Due to better usage of the wood, any order of this reference may contain mean percentage tables of between 15% y 20%.

Par un mejor aprovechamiento de la madera, cualquier pedido de esta referencia puede contener un porcentaje de medias tablas de entre 15% y 20%.

Pour mieux mettre à profit le bois, toute commande portant sur cette référence peut contenir un pourcentage de demi-planches de 15% y 20%.

Natural Wood



Legend 1L Light

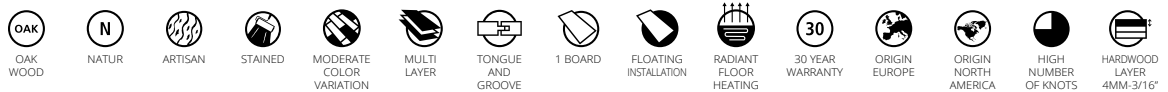

Description	Format	Codes	Group	Pcs	m2	Kg
Legend 1L Light	26x220x1,5cm 10 1/4"x86 5/8"x5/8"	100110285 L160803371	G-257	6 x Cj 168 x Pal	3,43 x Cj 96,10 x Pal	29,12 x Cj 815,47 x Pal
Skirting / Zócalo / Plinthe	8x220x1,4cm 3 1/8"x86 5/8"x1/2"	100114262 L165002541	G-128	12 x Cj 600 x Pal	2,11 x Cj 105,60 x Pal	16,56 x Cj 828 x Pal
Transition Profile / Perfil Transición / Profilé Jointoiment	4x270x1,3cm 1 5/8"x106 1/4"x1/2"	100114251 L165002554	G-161	10 x Cj 1000 x Pal	1,08 x Cj 108 x Pal	10,20 x Cj 1020 x Pal
Levelling Profile / Perfil Igualación / Profilé Égalisation	4,5x270x1,3cm 1 3/4"x106 1/4"x1/2"	100114235 L165002523	G-161	10 x Cj 1000 x Pal	1,08 x Cj 108 x Pal	10,20 x Cj 1020 x Pal
Stair Nosing / Mampelian / Nez de Marche	120x7x3cm 47 1/4"x2 3/4"x1 1/8"	100176574 L165003637	G-163	2 x Cj 200 x Pal	0,17 x Cj 16,80 x Pal	3,28 x Cj 327,80 x Pal

STOCK

Due to better usage of the wood, any order of this reference may contain mean percentage tables of between 15% y 20%.

Par un meilleur utilisation de la madera, cualquier pedido de esta referencia puede contener un porcentaje de medias tablas de entre 15% y 20%.

Pour mieux mettre à profit le bois, toute commande portant sur cette référence peut contenir un pourcentage de demi-planches de 15% y 20%.







Revival

—
Cognac
Oyster
Ocher

Natural Wood



Revival 1L
Cognac



Description	Format	Codes	Group	Pcs	m2	Kg
Revival 1L Cognac	22x220x2cm 8 5/8"x86 5/8"x7/8"	100146124 L165003005	G-278	4 x Cj 144 x Pal	1,93 x Cj 69,69 x Pal	25 x Cj 900 x Pal
Skirting / Zócalo / Plinthe	8x220x1,4cm 3 1/8"x86 5/8"x1/2"	100146572 L165003052	G-128	12 x Cj 600 x Pal	2,11 x Cj 105,60 x Pal	16,56 x Cj 828 x Pal
Transition Profile / Perfil Transición / Profilé Jointoiment	4x270x1,3cm 1 5/8"x106 1/4"x1/2"	100146544 L165003050	G-161	10 x Cj 1000 x Pal	1,08 x Cj 108 x Pal	10,20 x Cj 1020 x Pal
Levelling Profile / Perfil Igualación / Profilé Égalisation	4,5x270x1,3cm 1 3/4"x106 1/4"x1/2"	100146576 L165003043	G-161	10 x Cj 1000 x Pal	1,08 x Cj 108 x Pal	10,20 x Cj 1020 x Pal
Stair Nosing / Mampierlan / Nez de Marche	120x7x3cm 47 1/4"x2 3/4"x1 1/8"	100176598 L165003654	G-163	2 x Cj 200 x Pal	0,17 x Cj 16,80 x Pal	3,28 x Cj 327,80 x Pal

Due to better usage of the wood, any order of this reference may contain mean percentage tables of between 25% y 30%.

Por un mejor aprovechamiento de la madera, cualquier pedido de esta referencia puede contener un porcentaje de medias tablas de entre 25% y 30%.

Pour mieux mettre à profit le bois, toute commande portant sur cette référence peut contenir un pourcentage de demi-planches de 25% y 30%.

Natural Wood



Revival 1L
Oyster

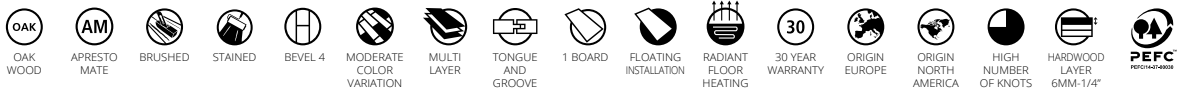

Description	Format	Codes	Group	Pcs	m2	Kg
Revival 1L Oyster	22x220x2cm 8 5/8"x86 5/8"x7/8"	100146125 L165003006	G-278	4 x Cj 112 x Pal	1,93 x Cj 54,21 x Pal	22,12 x Cj 619,47 x Pal
Skirting / Zócalo / Plinthe	8x220x1,4cm 3 1/8"x86 5/8"x1/2"	100146559 L165003046	G-128	12 x Cj 600 x Pal	2,11 x Cj 105,60 x Pal	16,56 x Cj 828 x Pal
Transition Profile / Perfil Transición / Profilé Jointoiment	4x270x1,3cm 1 5/8"x106 1/4"x1/2"	100146545 L165003054	G-161	10 x Cj 1000 x Pal	1,08 x Cj 108 x Pal	10,20 x Cj 1020 x Pal
Levelling Profile / Perfil Igualación / Profilé Égalisation	4,5x270x1,3cm 1 3/4"x106 1/4"x1/2"	100146577 L165003047	G-161	10 x Cj 1000 x Pal	1,08 x Cj 108 x Pal	10,20 x Cj 1020 x Pal
Stair Nosing / Mampierlan / Nez de Marche	120x7x3cm 47 1/4"x2 3/4"x1 1/8"	100176585 L165003657	G-163	2 x Cj 200 x Pal	0,17 x Cj 16,80 x Pal	3,28 x Cj 327,80 x Pal

Due to better usage of the wood, any order of this reference may contain mean percentage tables of between 25% y 30%.

Por un mejor aprovechamiento de la madera, cualquier pedido de esta referencia puede contener un porcentaje de medias tablas de entre 25% y 30%.

Pour mieux mettre à profit le bois, toute commande portant sur cette référence peut contenir un pourcentage de demi-planches de 25% y 30%.

Revival



Revival 1L Ocher

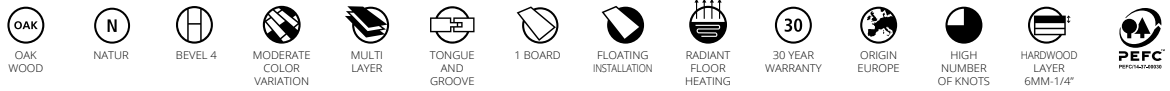

Description	Format	Codes	Group	Pcs	m2	Kg
Revival 1L Ocher	22x220x2cm 8 5/8"x86 5/8"x7/8"	100178404 L165003743	G-278	4 x Cj 112 x Pal	1,93 x Cj 54,21 x Pal	25 x Cj 700 x Pal
Skirting / Zócalo / Plinthe	8x220x1,4cm 3 1/8"x86 5/8"x5/8"	100180855 L165003775	G-128	12 x Cj 600 x Pal	2,11 x Cj 105,60 x Pal	16,56 x Cj 828 x Pal
Transition Profile / Perfil Transición / Profilé Jointoiment	4x270x1,3cm 1 5/8"x106 1/4"x1/2"	100180891 L165003768	G-161	10 x Cj 1000 x Pal	1,08 x Cj 108 x Pal	10,20 x Cj 1020 x Pal
Levelling Profile / Perfil Igualación / Profilé Egalisation	4,5x270x1,3cm 1 3/4"x106 1/4"x1/2"	100180870 L165003766	G-161	10 x Cj 1000 x Pal	1,08 x Cj 108 x Pal	10,20 x Cj 1020 x Pal
Stair Nosing / Mampelran / Nez de Marche	120x7x3cm 47 1/4"x 2 3/4"x1 1/8"	100180866 L165003773	G-163	2 x Cj 200 x Pal	0,17 x Cj 16,80 x Pal	3,28 x Cj 327,80 x Pal

Due to better usage of the wood, any order of this reference may contain mean percentage tables of between 25% y 30%.

Por un mejor aprovechamiento de la madera, cualquier pedido de esta referencia puede contener un porcentaje de medias tablas de entre 25% y 30%.

Pour mieux mettre à profit le bois, toute commande portant sur cette référence peut contenir un pourcentage de demi-planches de 25% y 30%.



Floor Coverings Revival 1L Ocher / Wall Coverings Glaze Hexagon Beiges Matt

The use of natural wood in kitchens shall be the responsibility of the client. / El uso de la madera natural en cocinas es bajo la responsabilidad del cliente. / Il est de la responsabilité du client l'utilisation du bois naturel dans les cuisines.

Authentic

—
Pure
Chrome
Bronze
Anthracite





Authentic 1L Pure



Description	Format	Codes	Group	Pcs	m2	Kg
Authentic 1L Pure	24x220x1,35cm 9 1/2"x86 5/8"x1/2"	100171983 L165003581	G-265	6 x Cj 198 x Pal	3,17 x Cj 104,54 x Pal	23,49 x Cj 775,17 x Pal
Skirting / Zócalo / Plinthe	8x220x1,4cm 3 1/8"x86 5/8"x9/16"	100177641 L165003732	G-128	12 x Cj 600 x Pal	2,11 x Cj 105,60 x Pal	31,22 x Cj 1561,20 x Pal
Aluminium Transition Profile / Perfil Transición Aluminio / Profilé jointolement Aluminium	4x270x1,3cm 1 5/8"x106 1/4"x1/2"	100049265 L164531141	G-161	10 x Cj 1000 x Pal	1,08 x Cj 107,99 x Pal	11,00 x Cj 1100 x Pal
Aluminium Levelling Profile / Perfil Igualación Aluminio / Profilé Egalisation Aluminium	4,5x270x1,3cm 1 3/4"x106 1/4"x1/2"	100031458 L164705091	G-161	10 x Cj 1000 x Pal	1,22 x Cj 121,51 x Pal	10,20 x Cj 1020 x Pal
Stair Nosing / Mampelan / Nez de Marche	120x7x3cm 47 1/4"x2 3/4"x1 1/8"	100176731 L165003719	G-163	2 x Cj 200 x Pal	0,17 x Cj 16,80 x Pal	3,28 x Cj 327,80 x Pal

Due to better usage of the wood, any order of this reference may contain mean percentage tables of between 20% y 25%.

Por un mejor aprovechamiento de la madera, cualquier pedido de esta referencia puede contener un porcentaje de medias tablas de entre 20% y 25%.

Pour mieux mettre à profit le bois, toute commande portant sur cette référence peut contenir un pourcentage de demi-planches de 20% y 25%.

Natural Wood



Authentic 1L Chrome

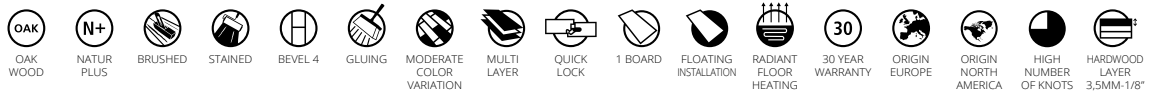

Description	Format	Codes	Group	Pcs	m2	Kg
Authentic 1L Chrome	24x220x1,35cm 9 1/2"x86 5/8"x1/2"	100171977 L165003580	G-265	6 x Cj 198 x Pal	3,17 x Cj 104,54 x Pal	23,49 x Cj 775,17 x Pal
Skirting / Zócalo / Plinthe	8x220x1,4cm 3 1/8"x86 5/8"x9/16"	100177660 L165003731	G-128	12 x Cj 600 x Pal	2,11 x Cj 105,60 x Pal	31,22 x Cj 1561,20 x Pal
Aluminium Transition Profile / Perfil Transición Aluminio / Profilé jointolement Aluminium	4x270x1,3cm 1 5/8"x106 1/4"x1/2"	100049265 L164531141	G-161	10 x Cj 1000 x Pal	1,08 x Cj 107,99 x Pal	11,00 x Cj 1100 x Pal
Aluminium Levelling Profile / Perfil Igualación Aluminio / Profilé Egalisation Aluminium	4,5x270x1,3cm 1 3/4"x106 1/4"x1/2"	100031458 L164705091	G-161	10 x Cj 1000 x Pal	1,22 x Cj 121,51 x Pal	10,20 x Cj 1020 x Pal
Stair Nosing / Mampelan / Nez de Marche	120x7x3cm 47 1/4"x2 3/4"x1 1/8"	100176728 L165003714	G-163	2 x Cj 200 x Pal	0,17 x Cj 16,80 x Pal	3,28 x Cj 327,80 x Pal

Due to better usage of the wood, any order of this reference may contain mean percentage tables of between 20% y 25%.

Por un mejor aprovechamiento de la madera, cualquier pedido de esta referencia puede contener un porcentaje de medias tablas de entre 20% y 25%.

Pour mieux mettre à profit le bois, toute commande portant sur cette référence peut contenir un pourcentage de demi-planches de 20% y 25%.

Authentic



Authentic 1L Bronze



Description	Format	Codes	Group	Pcs	m2	Kg
Authentic 1L Bronze	24x220x1,35cm 9 1/2"x86 5/8"x1/2"	100171976 L165003579	G-265	6 x Cj 198 x Pal	3,17 x Cj 104,54 x Pal	23,49 x Cj 775,17 x Pal
Skirting / Zócalo / Plinthe	8x220x1,4cm 3 1/8"x86 5/8"x9/16"	100177650 L165003733	G-128	12 x Cj 600 x Pal	2,11 x Cj 105,60 x Pal	31,22 x Cj 1561,20 x Pal
Aluminium Transition Profile / Perfil Transición Aluminio / Profilé Jointoiment Aluminium	4x270x1,3cm 1 5/8"x106 1/4"x1/2"	100049265 L164531141	G-161	10 x Cj 1000 x Pal	1,08 x Cj 107,99 x Pal	11,00 x Cj 1100 x Pal
Aluminium Levelling Profile / Perfil Igualación Aluminio / Profilé Égalisation Aluminium	4,5x270x1,3cm 1 3/4"x106 1/4"x1/2"	100031458 L164705091	G-161	10 x Cj 1000 x Pal	1,22 x Cj 121,51 x Pal	10,20 x Cj 1020 x Pal
Stair Nosing / Mampferlan / Nez de Marche	120x7x3cm 47 1/4"x2 3/4"x1 1/8"	100176741 L165003721	G-163	2 x Cj 200 x Pal	0,17 x Cj 16,80 x Pal	3,28 x Cj 327,80 x Pal

Due to better usage of the wood, any order of this reference may contain mean percentage tables of between 20% y 25%.

Por un mejor aprovechamiento de la madera, cualquier pedido de esta referencia puede contener un porcentaje de medias tablas de entre 20% y 25%.

Pour mieux mettre à profit le bois, toute commande portant sur cette référence peut contenir un pourcentage de demi-planches de 20% y 25%.



Authentic 1L Anthracite

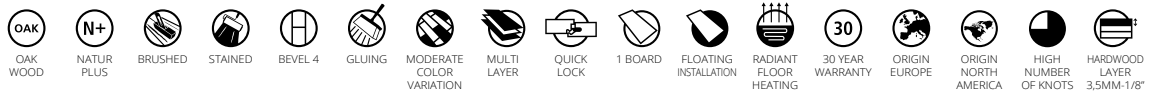

Description	Format	Codes	Group	Pcs	m2	Kg
Authentic 1L Anthracite	24x220x1,35cm 9 1/2"x86 5/8"x1/2"	100172000 L165003582	G-265	6 x Cj 198 x Pal	3,17 x Cj 104,54 x Pal	23,49 x Cj 775,17 x Pal
Skirting / Zócalo / Plinthe	8x220x1,4cm 3 1/8"x86 5/8"x9/16"	100177640 L165003734	G-128	12 x Cj 600 x Pal	2,11 x Cj 105,60 x Pal	31,22 x Cj 1561,20 x Pal
Aluminium Transition Profile / Perfil Transición Aluminio / Profilé Jointoiment Aluminium	4x270x1,3cm 1 5/8"x106 1/4"x1/2"	100049265 L164531141	G-161	10 x Cj 1000 x Pal	1,08 x Cj 107,99 x Pal	11,00 x Cj 1100 x Pal
Aluminium Levelling Profile / Perfil Igualación Aluminio / Profilé Égalisation Aluminium	4,5x270x1,3cm 1 3/4"x106 1/4"x1/2"	100031458 L164705091	G-161	10 x Cj 1000 x Pal	1,22 x Cj 121,51 x Pal	10,20 x Cj 1020 x Pal
Stair Nosing / Mampferlan / Nez de Marche	120x7x3cm 47 1/4"x2 3/4"x1 1/8"	100176740 L165003716	G-163	2 x Cj 200 x Pal	0,17 x Cj 16,80 x Pal	3,28 x Cj 327,80 x Pal

Due to better usage of the wood, any order of this reference may contain mean percentage tables of between 20% y 25%.

Por un mejor aprovechamiento de la madera, cualquier pedido de esta referencia puede contener un porcentaje de medias tablas de entre 20% y 25%.

Pour mieux mettre à profit le bois, toute commande portant sur cette référence peut contenir un pourcentage de demi-planches de 20% y 25%.





Nature

—
Toasted
Brown
Grey
White
Natural

Natural Wood



Nature 1L
Toasted



Description	Format	Codes	Group	Pcs	m2	Kg
Nature 1L Toasted	17,3x220x1,35cm	100213795	G-263	8 x Cj	3,04 x Cj	24,81 x Cj
	6 3/4"x86 5/8"x1/2"	L165004058		256 x Pal	97,43 x Pal	793,86 x Pal
Skirting / Zócalo / Plinthe	8x220x1,4cm	100214463	G-128	12 x Cj	2,11 x Cj	16,56 x Cj
	3 1/8"x86 5/8"x9/16"	L165004099		600 x Pal	105,60 x Pal	828 x Pal
Transition Profile / Perfil Transición / Profilé jointoiment	4x270x1,3cm	100214399	G-161	10 x Cj	1,08 x Cj	10,20 x Cj
	1 5/8"x106 1/4"x1/2"	L165004122		1000 x Pal	108 x Pal	1020 x Pal
Levelling Profile / Perfil Igualación / Profilé Égalisation	4,5x270x1,3cm	100214413	G-161	10 x Cj	1,08 x Cj	10,20 x Cj
	1 3/4"x106 1/4"x1/2"	L165004119		1000 x Pal	108 x Pal	1020 x Pal
Stair Nosing / Mampierlan / Nez de Marche	120x7x3cm	100214415	G-163	2 x Cj	0,17 x Cj	3,28 x Cj
	47 1/4"x2 3/4"x1 1/8"	L165004090		200 x Pal	16,80 x Pal	327,80 x Pal

NEW

Natural Wood



Nature 1L
Brown

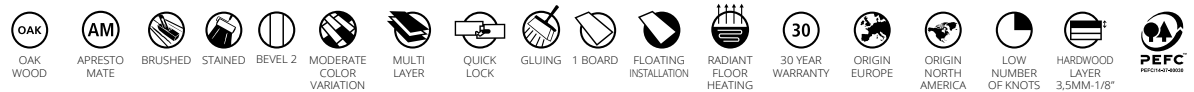

Description	Format	Codes	Group	Pcs	m2	Kg
Nature 1L Brown	17,3x220x1,35cm	100213801	G-257	8 x Cj	3,04 x Cj	24,81 x Cj
	6 3/4"x86 5/8"x1/2"	L165004057		256 x Pal	97,43 x Pal	793,86 x Pal
Skirting / Zócalo / Plinthe	8x220x1,4cm	100214461	G-128	12 x Cj	2,11 x Cj	16,56 x Cj
	3 1/8"x86 5/8"x9/16"	L165004127		600 x Pal	105,60 x Pal	828 x Pal
Transition Profile / Perfil Transición / Profilé jointoiment	4x270x1,3cm	100214408	G-161	10 x Cj	1,08 x Cj	10,20 x Cj
	1 5/8"x106 1/4"x1/2"	L165004107		1000 x Pal	108 x Pal	1020 x Pal
Levelling Profile / Perfil Igualación / Profilé Égalisation	4,5x270x1,3cm	100214411	G-161	10 x Cj	1,08 x Cj	10,20 x Cj
	1 3/4"x106 1/4"x1/2"	L165004106		1000 x Pal	108 x Pal	1020 x Pal
Stair Nosing / Mampierlan / Nez de Marche	120x7x3cm	100214398	G-163	2 x Cj	0,17 x Cj	3,28 x Cj
	47 1/4"x2 3/4"x1 1/8"	L165004136		200 x Pal	16,80 x Pal	327,80 x Pal

NEW

Nature



Nature 1L Grey

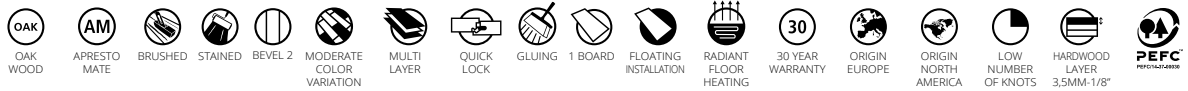

Description	Format	Codes	Group	Pcs	m2	Kg
Nature 1L Grey	17,3x220x1,35cm 6 3/4"x86 5/8"x1/2"	100213783 L165004053	G-257	8 x Cj 256 x Pal	3,04 x Cj 97,43 x Pal	24,81 x Cj 793,86 x Pal
Skirting / Zócalo / Plinthe	8x220x1,4cm 3 1/8"x86 5/8"x9/16"	100214419 L165004086	G-128	12 x Cj 600 x Pal	2,11 x Cj 105,60 x Pal	16,56 x Cj 828 x Pal
Transition Profile / Perfil Transición / Profilé Jointolement	4x270x1,3cm 1 5/8"x106 1/4"x1/2"	100214423 L165004128	G-161	10 x Cj 1000 x Pal	1,08 x Cj 108 x Pal	10,20 x Cj 1020 x Pal
Levelling Profile / Perfil Igualación / Profilé Egalisation	4,5x270x1,3cm 1 3/4"x106 1/4"x1/2"	100214394 L165004092	G-161	10 x Cj 1000 x Pal	1,08 x Cj 108 x Pal	10,20 x Cj 1020 x Pal
Stair Nosing / Mampelran / Nez de Marche	120x7x3cm 47 1/4"x2 3/4"x1 1/8"	100214379 L165004089	G-163	2 x Cj 200 x Pal	0,17 x Cj 16,80 x Pal	3,28 x Cj 327,80 x Pal

STOCK

NEW



Nature 1L White



Description	Format	Codes	Group	Pcs	m2	Kg
Nature 1L White	17,3x220x1,35cm 6 3/4"x86 5/8"x1/2"	100213810 L165004060	G-257	8 x Cj 256 x Pal	3,04 x Cj 97,43 x Pal	24,81 x Cj 793,86 x Pal
Skirting / Zócalo / Plinthe	8x220x1,4cm 3 1/8"x86 5/8"x9/16"	100214433 L165004138	G-128	12 x Cj 600 x Pal	2,11 x Cj 105,60 x Pal	16,56 x Cj 828 x Pal
Transition Profile / Perfil Transición / Profilé Jointolement	4x270x1,3cm 1 5/8"x106 1/4"x1/2"	100214388 L165004133	G-161	10 x Cj 1000 x Pal	1,08 x Cj 108 x Pal	10,20 x Cj 1020 x Pal
Levelling Profile / Perfil Igualación / Profilé Egalisation	4,5x270x1,3cm 1 3/4"x106 1/4"x1/2"	100214401 L165004131	G-161	10 x Cj 1000 x Pal	1,08 x Cj 108 x Pal	10,20 x Cj 1020 x Pal
Stair Nosing / Mampelran / Nez de Marche	120x7x3cm 47 1/4"x2 3/4"x1 1/8"	100214416 L165004098	G-163	2 x Cj 200 x Pal	0,17 x Cj 16,80 x Pal	3,28 x Cj 327,80 x Pal

NEW



Nature 1L
Natural

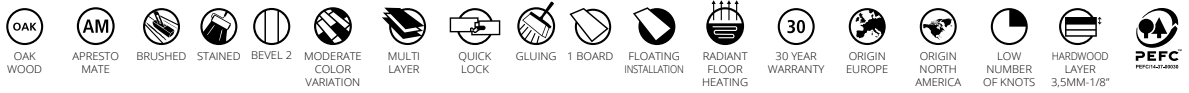

Description	Format	Codes	Group	Pcs	m2	Kg
Nature 1L Natural	17,3x220x1,35cm	100213749	G-257	8 x Cj	3,04 x Cj	24,81 x Cj
	6 3/4"x86 5/8"x1/2"	L165004056		256 x Pal	97,43 x Pal	793,86 x Pal
Skirting / Zócalo / Plinthe	8x220x1,4cm	100214462	G-128	12 x Cj	2,11 x Cj	16,56 x Cj
	3 1/8"x86 5/8"x9/16"	L165004116		600 x Pal	105,60 x Pal	828 x Pal
Transition Profile / Perfil Transición / Profilé jointoiment	4x270x1,3cm	100214424	G-161	10 x Cj	1,08 x Cj	10,20 x Cj
	1 5/8"x106 1/4"x1/2"	L165004120		1000 x Pal	108 x Pal	1020 x Pal
Levelling Profile / Perfil Igualación / Profilé Égalisation	4,5x270x1,3cm	100214412	G-161	10 x Cj	1,08 x Cj	10,20 x Cj
	1 3/4"x106 1/4"x1/2"	L165004123		1000 x Pal	108 x Pal	1020 x Pal
Stair Nosing / Mampelran / Nez de Marche	120x7x3cm	100214414	G-163	2 x Cj	0,17 x Cj	3,28 x Cj
	47 1/4"x2 3/4"x1 1/8"	L165004091		200 x Pal	16,80 x Pal	327,80 x Pal

STOCK

NEW



Wood Lovers

CREATED BY YOU FOR YOU

Wood Lovers is about a passion for wood and a love for its natural forms. But above all, it is collection designed especially for you. Our selection process allows you to design the surface of your floor down to the last detail, giving a central role to versatility and resistance over time. First, select the colour of wood that best suits your project from eight shades that conjure up images of nature in its purest state.

Then, choose the finish you like best. Two options which also guarantee the protection and durability of the wood with the use of the most advanced types of varnish.

Next, select the texture. Evoke the feel of a wood worn by the passage of time, recall traditional pieces or reminisce over age-old techniques used in the treatment of wood.

Lastly, decide on the format you wish to use for the boards. Combine different lengths and widths, depending on whether you are looking for a uniform result or something more random and original.

Our selection process lets you discover a unique and unrepeatable product, designed by you and for you. Share the Woodlovers' passion. Fall in love with us.

POR TI Y PARA TI

Wood Lovers es pasión por la madera y amor por sus formas naturales. Pero sobre todo, es una colección pensada para ti. Nuestro proceso de selección permite que configures la superficie de tu suelo hasta el más mínimo detalle, apostando por la versatilidad y la resistencia al paso del tiempo.

En primer lugar, elige el color de la madera que mejor se adapte a tu proyecto mediante ocho tonos que evocan la naturaleza en estado puro.

A continuación, escoge el acabado que más te guste. Dos opciones que, además, garantizan la protección y durabilidad de la madera a través de los barnices más avanzados.

Selecciona la textura. Evoca la madera desgastada por el paso del tiempo, recuerda las piezas tradicionales o rememora las técnicas milenarias en el tratamiento de la madera.

Finalmente, decide qué formato deseas para las lamas. Puedes combinar las piezas con distintos anchos y largos, buscando un resultado homogéneo o más arbitrario y original.

Con nuestro proceso descubrirás un producto final único e irreplicable, pensado por ti y para ti. Comparte la pasión de Woodlovers. Enamórate con nosotros.

FAIT PAR VOUS ET POUR VOUS

Wood Lovers fait référence à la passion du bois et l'amour de ses formes naturelles. Mais c'est avant tout une collection imaginée pour vous. Notre processus de sélection vous permet de congurer la surface de votre plancher dans le moindre détail, misant ainsi sur l'adaptabilité et la résistance au passage du temps.

Tout d'abord, vous choisissez la couleur du bois qui convient le mieux à votre projet parmi huit tons qui évoquent la nature à l'état pur.

Vous sélectionnez ensuite la finition que vous préférez. Ces choix vous permettent en outre de garantir la protection et la durabilité du bois grâce aux vernis les plus performants.

Choisissez la texture. Rappelez le bois usé par le temps, remémorez les pièces traditionnelles ou faites revivre les techniques millénaires de traitement du bois. Enn, décidez du format que vous souhaitez pour vos lames.

Vous pouvez combiner des pièces de différentes longueurs et largeurs pour un résultat homogène ou plus aléatoire et original.

Notre processus vous offre un produit nal unique et inimitable, imaginé par vous et pour vous. Laissez-vous séduire, vivez la passion Woodlovers.



1. Select the colour of your wood
Elige el color de tu madera
Choisissez la couleur de votre bois



Wood Lovers 1L Brown

Embracing classic forms.
Abraza las formas clásicas.
Embrasse les formes classiques.

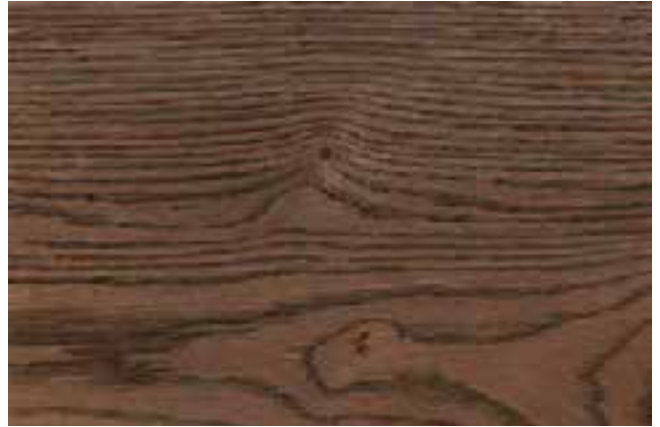

Wood Lovers 1L Brown Lisbon

The elegance of cosmopolitan wood.
La elegancia de la madera cosmopolita.
L'élégance du bois cosmopolite.



Wood Lovers 1L Grey Night

Where distinction and modernism come together.
Donde se unen distinción y modernidad.
Alliance de distinction et modernité.



Wood Lovers 1L Natural

Let yourself be wrapped up in nature.
Déjate envolver por la naturaleza.
Laissez la nature vous envelopper.



Wood Lovers 1L Grey Newman

On the horizon of simple pleasures.
En el horizonte de las cosas sencillas.
Sur la voie des choses simples.



Wood Lovers 1L Warm Ocean

A cascade of sensations.
Una cascada de sensaciones.
Une cascade de sensations.

Wood Lovers

2. Define the texture

Define el tipo de textura

Dénissez le type de texture

Select or combine any of our textures to obtain an exclusive effect.

Escoge cualquiera de nuestras texturas o combínalas como más te guste para lograr un efecto exclusivo.

Choisissez l'une de nos textures ou combinez-en plusieurs selon vos envies pour un effet exclusif.



Distressed Effect

The long sides of each strip are worn away using a plane that chips the wood, achieving an imperfect finish and giving the floor pattern a certain unevenness.

Efecto Distressed

Los perfiles largos de cada lama están desgastados mediante un cepillo que astilla la madera, logrando un acabado imperfecto que huye de la homogeneidad en el patrón del suelo.

Effet Distressed

Les proles longs de chaque lame sont usés à l'aide d'un rabot qui fend le bois, on obtient ainsi une finition imparfaite qui s'éloigne de l'homogénéité du patron de plancher.



Artisan Effect

In the way of carpenters of old, this finish imitates the traditional hand planing of wood, giving it a rough artisan look.

Efecto Artisan

Como hicieran los ebanistas de antaño, el acabado imita el tradicional cepillado a mano de la madera, proporcionando un aspecto rudo y artesano.

Effet Artisan

Comme chez les ébénistes d'antan, la finition imite le brossage traditionnel à la main, donnant au bois un aspect rude et artisanal.



Handcraft Effect

A "handmade" finish producing a more natural effect, maintaining the original knots of the branches and bark of the trees. The result enhances the grain of the wood and achieves a unique design for each piece.

Efecto Handcraft

Un acabado "hecho a mano" que provoca un efecto más natural, manteniendo los nudos propios de las ramas y la corteza de los árboles. El resultado aumenta las vetas de la madera y logra un diseño único en cada pieza.

Effet Handcraft

Une finition de produit «fait à la main» qui donne un effet plus naturel, tout en conservant les noeuds propres aux branches et à l'écorce des arbres. Le résultat est un design unique à chaque pièce qui favorise les veines du bois.

3. Select strip format

Selecciona el formato de las lamas
Sélectionnez le format des lames

Selecting one width measurement which is repeated for all the pieces, while the length varies from 210 to 420cm. The variation in length is at maximum 20% with respect to the shortest strip and 20% or more of the longest strip.

Eligiendo una medida en cuanto al ancho de la lama que se repetirá en todas las piezas mientras que el largo variará de 210 a 420cm. La variación del largo será de un 20% como máximo con respecto a la lama más corta y un 20% o más de la medida más larga.

Choix d'une largeur de lame appliquée à toutes les pièces; la longueur varie entre 210 et 420cm. La longueur variera au maximum de 20% par rapport à la lame la plus courte et de 20% ou plus par rapport à la mesure la plus longue.

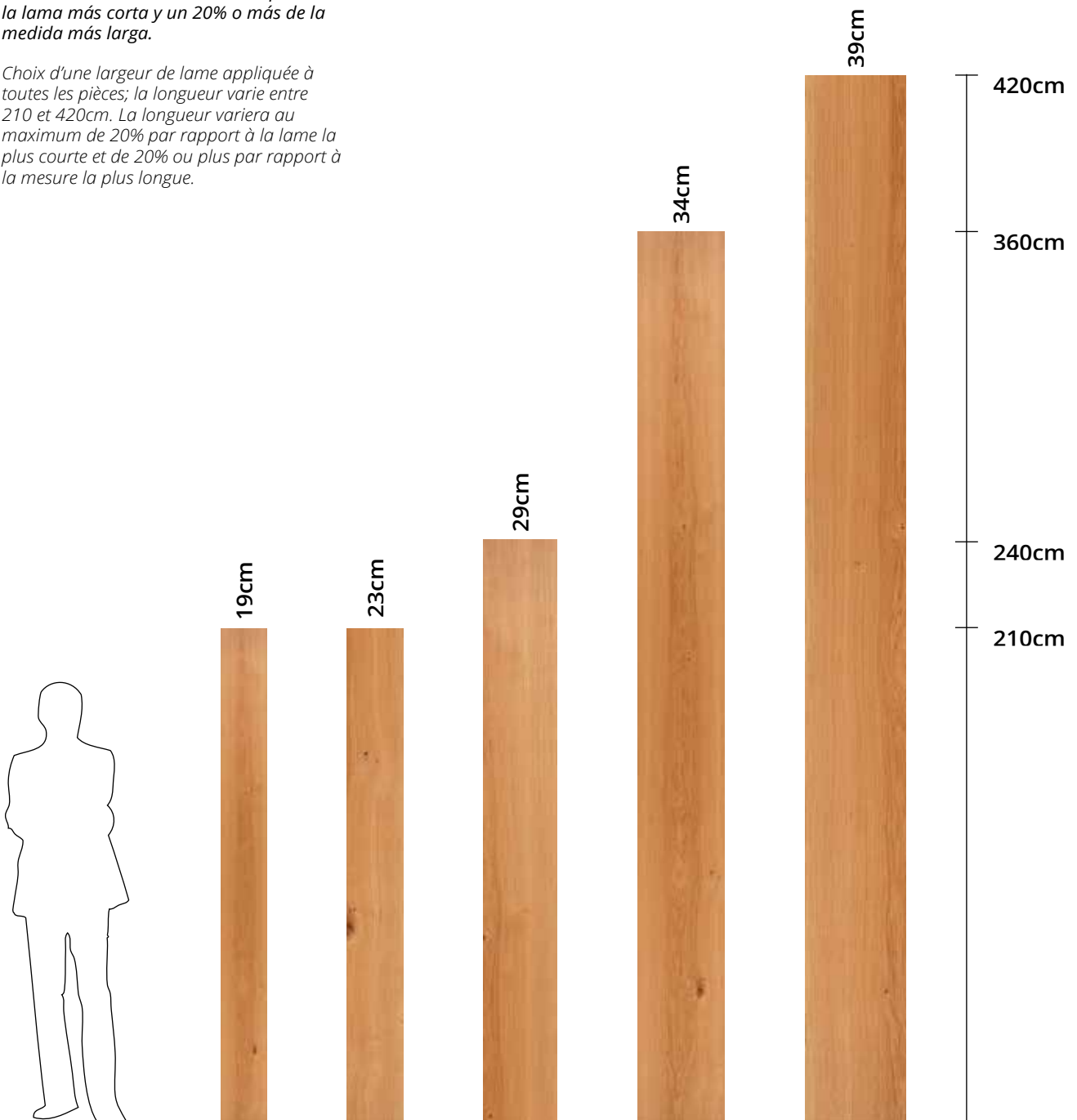

Wood Lovers

4. Enjoy an exclusive natural wood floor
Disfruta tu suelo exclusivo de madera natural
Jouissez d'un sol exclusif en bois naturel



SPECIAL PIECES / PIEZAS ESPECIALES / PIÈCES SPÉCIALES

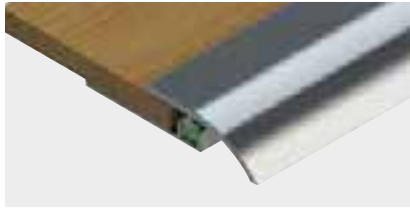

Aluminium Levelling Profile
 Perfil Igualación Aluminio
 Profilé égalisation Aluminium

4,5x270x1,3cm - 1 3/4"x106 1/4"x1/2"

100031458 - L164705091 - G-161

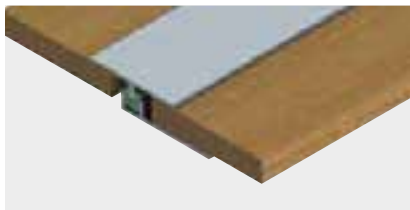

Aluminium Transition Profile
 Perfil Transición Aluminio
 Profilé Jointoiement Aluminium

4x270x1,3cm - 1 5/8"x106 1/4"x1/2"

100049265 - L164531141 - G-161



White Skirting
 Zócalo Parquet Blanco
 Plinthe Parquet Blanc

8x220x1,5cm - 3 1/8"x86 5/8"x5/8"

100115023 - L165002603 - G-107



Stair Nosing
 Mamperlan
 Nez de Marche

120x7x3cm - 47 1/4"x2 3/4"x1 1/8"

The nosing can be made with three different locking systems: Quick Lock, Lock, or Tongue and Groove. These pieces are made with the same base as the parquet with mitered slats.

El mamperlán puede estar realizado con tres sistemas diferentes de unión: Quick Lock, Lock o Machihembrado. Estas piezas están realizadas con la misma base que el Parquet ingletando lamas.

Le nez de marche peut être réalisé avec trois systèmes d'assemblage différents: Quick Lock, Lock ou à rainures et languettes. Ces pièces sont fabriquées avec la même base que le parquet avec des coupes d'onglets sur les lames.

SUBSTRATES / SUBSUELOS / SOUS-COUCHES



Antistatic Underfloor Heating Layer
 Lamina Suelo Radiante Antiestática
 Sous-Couche Plancher Rayonnant Antistatique

25m2 - 100175300 - L165003722 - G-169

A lining made of recycled closed-cell rubber with an aluminium layer that dissipates heat and eliminates static electricity. This protection can be used over underfloor heating and reduces impact noise by 26dB airborne noise by 22dB.

Lámina realizada con caucho reciclado de celda cerrada que cuenta con una capa de aluminio capaz de repartir el calor y eliminar la electricidad estática. Esta protección se puede utilizar sobre suelo radiante y reduce el sonido de impacto en 26dB y el aéreo en 22dB.

Sous-couche en caoutchouc recyclé à cellules fermées composée d'une couche d'aluminium capable de répartir la chaleur et d'éliminer l'électricité statique. Cette protection peut être utilisée sous un plancher rayonnant, elle réduit les sons d'impact de 26dB et les sons aériens de 22dB.



Insulating Layer
 Lamina Aislante
 Sous-Couche Isolante

79x59x0,5cm - 100059778 - L180112013 - G-104

5mm-thick sound insulation useful for rectifying uneven patches.

Aislante acústico de 5 mm de grosor, útil para corregir desniveles.

Isolant phonique de 5 mm d'épaisseur, utile pour compenser des différences de niveaux.



Sous-Couche Anti-Humidité + Mousse
 Lamina Antihumedad + Espuma
 Damp Proofing Sheet + Foam

22m2 - 100169988 - L180112046 - G-151

140m2 - 100170010 - L180112045 - G-169

Sound insulation and damp proofing for parquet and laminate flooring.

Aislante acústico y antihumedad para el parquet y el laminado.

Isolant phonique et anti-humidité pour les parquets et les planchers stratifiés.

Wood Products / Productos Madera / Produits Bois

MAINTENANCE PRODUCTS / PRODUCTOS MANTENIMIENTO / PRODUITS D'ENTRETIEN N N+



Regular cleaning of wood floors. Removes deeply ingrained dust and grease, without leaving a film.
Limpieza habitual de suelos de madera. Elimina en profundidad el polvo y la grasa, sin dejar una película.
Nettoyage habituel des sols en bois. Élimine en profondeur la poussière et la graisse, sans laisser de pellicule.

Rmc Soap 1L

100158383 - L180112039 - G-140

Solution / Dilución / Dilution 1:100
One litre covers / Rendimiento / Rendement 1500 m²/L



Stain and spot remover for varnished and oiled wood floors.
Limpieza de las manchas localizadas de suelos de parquet tanto barnizados como aceitados.
Nettoyage des tâches localisées sur les parquets vernis ou huilés.

Rmc Surface Care 750 mL

100158385 - L180112038 - G-140

Use without diluting / Usar sin diluir / À utiliser non dilué



Hard water stain remover for varnished and oiled wood floors.
Limpieza de las manchas de agua con cal en suelos de parquet tanto barnizados como aceitados.
Nettoyage des traces d'eau calcaire sur les parquets vernis ou huilés.

Rmc Limespot Remove 0,5 L

100158382 - L180112041 - G-140

Use without diluting / Usar sin diluir / À utiliser non dilué



Maintenance of all oiled and varnished floors. This product can also be used on varnished surfaces in which micro-cracks are starting to appear.
Mantenimiento de todos los suelos aceitados y barnizados. Este producto también se puede utilizar sobre superficies barnizadas que empiecen a tener micro grietas.
Entretien de tous les sols huilés et vernis. Ce produit peut également être appliqué sur des surfaces vernies qui présentent des microfissures naissantes.

Rmc Universal Maintenance Oil Voc Free Pure 0,5 L

100158387 - L180112037 - G-169

Rmc Universal Maintenance Oil Voc Free Color 0,5 L

100158386 - L180112035 - G-169

Use without diluting / Usar sin diluir / À utiliser non dilué
One litre covers / Rendimiento / Rendement (35-50) m²/L



Oil stain and spot remover for varnished and oiled wood floors.
Limpieza de las manchas recientes de grasa en suelos de parquet tanto barnizados como aceitados.
Nettoyage des tâches récentes de graisse sur les parquets vernis ou huilés.

Rmc Grease Remove 0,5 L

100158381 - L180112040 - G-140

Use without diluting / Usar sin diluir / À utiliser non dilué



Natur and Naturplus wood surface protection.
Protección de superficies de madera Natur y Naturplus.
Protection de surface des bois Natur et Naturplus.

Clean and Green Aqua Oil 1L

100148088 - L167012434 - G-163

Use without diluting / Usar sin diluir / À utiliser non dilué
One litre covers / Rendimiento / Rendement (50-65) m²/L

MAINTENANCE PRODUCTS / PRODUCTOS MANTENIMIENTO / PRODUITS D'ENTRETIEN A AM



Regular cleaning of wood floors. Removes deeply ingrained dust and grease, without leaving a film.
Limpieza habitual de suelos de madera. Elimina en profundidad el polvo y la grasa, sin dejar una película.
Nettoyage habituel des sols en bois. Élimine en profondeur la poussière et la graisse, sans laisser de pellicule.

Rmc Soap 1L

100158383 - L180112039 - G-140

Solution / Dilución / Dilution 1:100
One litre covers / Rendimiento / Rendement 1500 m²/L



Stain and spot remover for varnished and oiled wood floors.
Limpieza de las manchas localizadas de suelos de parquet tanto barnizados como aceitados.
Nettoyage des tâches localisées sur les parquets vernis ou huilés.

Rmc Surface Care 750 ML

100158385 - L180112038 - G-140

Use without diluting / Usar sin diluir / À utiliser non dilué



Hard water stain remover for varnished and oiled wood floors.
Limpieza de las manchas de agua con cal en suelos de parquet tanto barnizados como aceitados.
Nettoyage des traces d'eau calcaire sur les parquets vernis ou huilés.

Rmc Limespot Remove 0,5 L

100158382 - L180112041 - G-140

Use without diluting / Usar sin diluir / À utiliser non dilué



Maintenance of all oiled and varnished floors. This product can also be used on varnished surfaces in which micro-cracks are starting to appear.
Mantenimiento de todos los suelos aceitados y barnizados. Este producto también se puede utilizar sobre superficies barnizadas que empiecen a tener micro grietas.
Entretien de tous les sols huilés et vernis. Ce produit peut également être appliqué sur des surfaces vernies qui présentent des microfissures naissantes.

Rmc Universal Maintenance Oil Voc Free Pure 0,5 L

100158387 - L180112037 - G-169

Rmc Universal Maintenance Oil Voc Free Color 0,5 L

100158386 - L180112035 - G-169

Use without diluting / Usar sin diluir / À utiliser non dilué
One litre covers / Rendimiento / Rendement (35-50) m²/L



Oil stain and spot remover for varnished and oiled wood floors.
Limpieza de las manchas recientes de grasa en suelos de parquet tanto barnizados como aceitados.
Nettoyage des tâches récentes de graisse sur les parquets vernis ou huilés.

Rmc Grease Remove 0,5 L

100158381 - L180112040 - G-140

Use without diluting / Usar sin diluir / À utiliser non dilué



Intensive maintenance and cleaning of laminate wood.
Mantenimiento laminado y limpieza intensiva de maderas.
Entretien et nettoyage intensif de bois stratifié.

Clean and Green Active 0,5 L

100148087 - L167012432 - G-128

Solution / Dilución / Dilution 1:200
One litre covers / Rendimiento / Rendement 1500 m²/L

PARQUET INSTALLATION / INSTALACIÓN PARQUET / POSE DE PARQUET



Printing of single-component polyurethane for disaggregated floors prior to gluing of parquets.
Imprimación de poliuretano monocomponente destinada a la consolidación de soleras disgregadas previo al encolado de parquets.
Imprégnation en polyuréthane monocomposant conçue pour la consolidation des sols désagrégés avec l'encollage des parquets.

Imprimacion 99 (25 Lt)

100221365 - L180112048 - G-173

Use without thinning / Usar sin diluir / À utiliser non dilué
 Coverage / Rendimiento / Rendement: 250 ml/m²



Hybrid based single-component adhesive, spreadable for all types of parquet floors.
Adhesivo base híbrida, monocomponente y espatulable para todo tipo de parquets.
Mortier-collé à base hybride, monocomposant et applicable à la spatule, pour tout type de parquet.

Hpa 180 21 Kg

100221354 - L180112047 - G-171

Use without thinning / Usar sin diluir / À utiliser non dilué
 Coverage / Rendimiento / Rendement: 0,6-1 Kg/m²



Adhesive to bond the strips together.
Adhesivo para unir las lamas entre si.
Colle pour le raccordement des lames.

Cola Blanca 750 Gr.

100148089 - L180112023 - G-128

Use without thinning / Usar sin diluir / À utiliser non dilué
 Coverage / Rendimiento / Rendement: 10 m²/L

SHADE VARIATION / VARIACIÓN DE COLOR / ALTÉRATION DE LA COULEUR

Natural Wood

NOT EXPOSED
 NO EXPUESTA
 NON EXPOSÉ

EXPOSED TO SUNLIGHT
 EXPUESTA A LA LUZ
 EXPOSÉ À LA LUMIÈRE



MERBAU

NOT EXPOSED
 NO EXPUESTA
 NON EXPOSÉ

EXPOSED TO SUNLIGHT
 EXPUESTA A LA LUZ
 EXPOSÉ À LA LUMIÈRE



JATOBA

NOT EXPOSED
 NO EXPUESTA
 NON EXPOSÉ

EXPOSED TO SUNLIGHT
 EXPUESTA A LA LUZ
 EXPOSÉ À LA LUMIÈRE



EBANO

NOT EXPOSED
 NO EXPUESTA
 NON EXPOSÉ

EXPOSED TO SUNLIGHT
 EXPUESTA A LA LUZ
 EXPOSÉ À LA LUMIÈRE



IROKO

NOT EXPOSED
 NO EXPUESTA
 NON EXPOSÉ

EXPOSED TO SUNLIGHT
 EXPUESTA A LA LUZ
 EXPOSÉ À LA LUMIÈRE



HAYA

NOT EXPOSED
 NO EXPUESTA
 NON EXPOSÉ

EXPOSED TO SUNLIGHT
 EXPUESTA A LA LUZ
 EXPOSÉ À LA LUMIÈRE



ROBLE

COLOUR CHANGES IN NATURAL WOOD

Real wood parquet flooring is a living product that changes with the passing of time. These unique floor coverings can undergo changes in colour as a result of constant exposure to light. These changes are foreseeable, and they can be reduced by altering the position of the room's furniture from time to time. These photographs show the shade variation that different woods can undergo through constant exposure to light.

CAMBIOS DE COLOR EN LA MADERA NATURAL

Los parquets de madera natural son productos vivos que cambian con el paso del tiempo. Elementos únicos que, si se exponen continuamente a la luz pueden sufrir alteraciones de color. Estas variaciones son previsibles y se pueden mitigar con movimientos periódicos del mobiliario de la estancia. Estas imágenes muestran las variaciones de tonos que sufren las diferentes maderas al estar expuestas continuamente a la luz.

CHANGEMENTS DE COULEUR SUR LE BOIS NATUREL

Les parquets en bois naturel sont des produits vivants qui évoluent au fil du temps. Il s'agit d'éléments uniques dont les couleurs peuvent s'altérer sous l'effet d'une exposition constante à la lumière. Ces variations sont prévisibles et peuvent être atténuées en déplaçant périodiquement le mobilier de la pièce d'habitation. Les images ci-dessus illustrent les variations de tons que les différents bois subissent lorsqu'ils sont exposés à la lumière en permanence.

Wood Products / Productos Madera / Produits Bois

HYGROSCOPIC BALANCE MOISTURE OF THE WOOD / HUMEDAD EQUILIBRIO HIGROSCÓPICO DE LA MADERA / HUMIDITÉ ÉQUILIBRE HYGROSCOPIQUE DU BOIS

The Kollman index provides a value that determines the hygroscopic balance of wood. The internal moisture content of the wood, which indicates if it is in satisfactory condition for use, can be ascertained by taking the relative humidity and room temperature data into account. For example, in a dwelling with the following hygrometric features: Relative humidity 60% and temperature 20°C; the moisture content of the wood should be between 11% and 12%. Any value above or below this range indicates that the wood will be subject to stress that could give rise to distortion or cracks in the boards if installed.

El Abaco de Kollman es un valor que marca el equilibrio higroscópico de la madera. Teniendo en cuenta los datos de la humedad relativa y temperatura de la estancia podemos saber la humedad interna de la madera, que nos marcará si ésta tiene las condiciones óptimas para ser instalada. Por ejemplo, en una vivienda cuyas condiciones higrométricas son: Hr 60% y T 20°C; la humedad de la madera debe oscilar entre el 11% y 12%. Cualquier valor que esté por encima o por debajo de este resultado indica que la madera está sometida a estrés, lo que puede provocar deformaciones o grietas en las tablas.

L'abaque de Kollman est une valeur qui dénit l'équilibre hygroscofique du bois. En tenant compte de l'humidité relative et la température d'une pièce, on peut déterminer l'humidité interne du bois, ce qui nous permet de savoir s'il se trouve dans des conditions optimales pour être installé. Par exemple, dans une habitation présentant les conditions hygrométriques suivantes: Hr = 60% et T = 20°C; l'humidité du bois doit varier entre 11% et 12%. Toute résultat non compris dans ces valeurs indique que le bois est soumis à des contraintes, ce qui peut entraîner des déformations ou des ssures des planches.

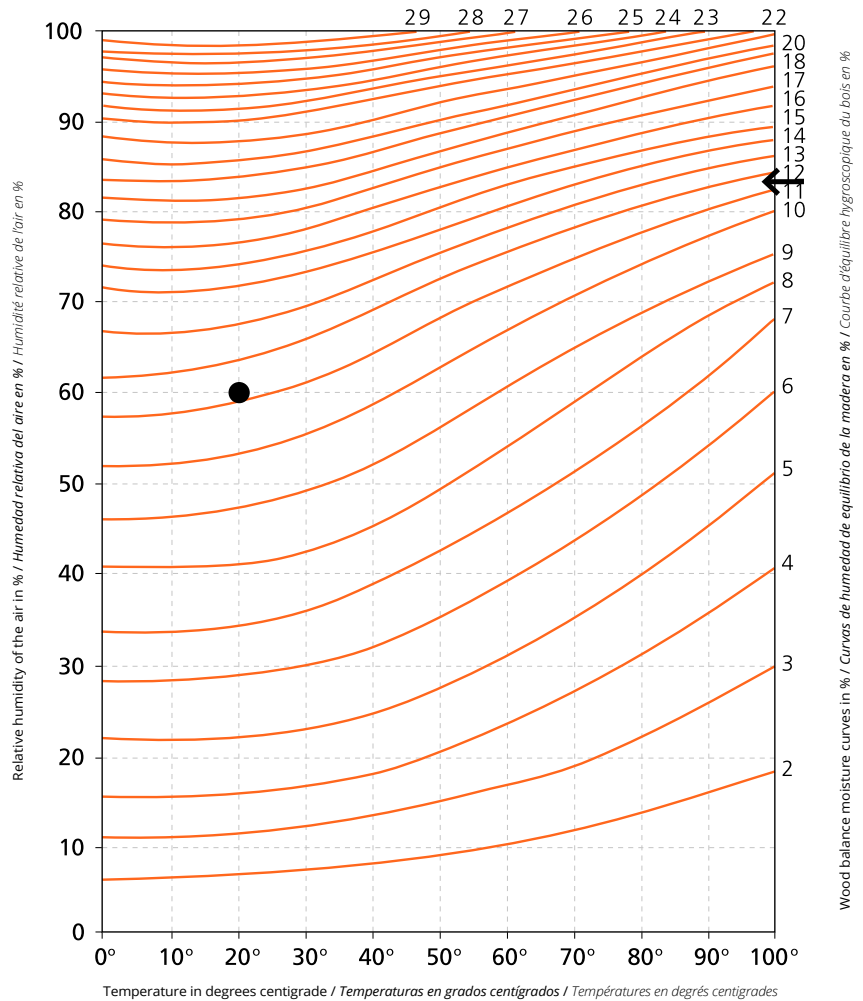

Natural Wood



Floor Coverings Artisan 1L Woven

The use of natural wood in baths shall be the responsibility of the client. / El uso de la madera natural en baños es bajo la responsabilidad del cliente. / Il est de la responsabilité du client l'utilisation du bois naturel dans les bains

BEFORE INSTALLING

ANTES DE INSTALAR

AVANT L'INSTALLATION

1. Receiving and storage.

1. Recepción y almacenaje.

1. Réception et stockage.

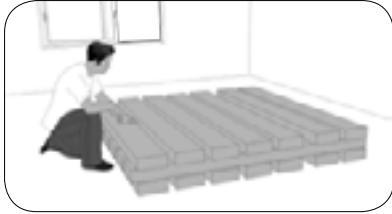

Verify the material and the installation location.

Verificar el material y el lugar de la instalación.

Vérifier le matériel et le lieu de l'installation.

2. Climatic conditions.

2. Condiciones climáticas.

2. Conditions climatiques.

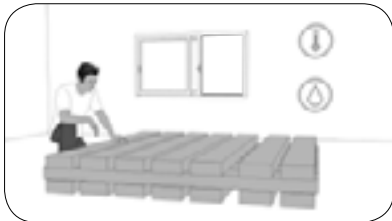

Temp. 10-27°C/65-80°F; 40-65% relative humidity.

T° 10-27°C/65-80°F; Humedad relativa 40-65%.

Température: 10-27°C/65-80°F; humidité relative: 40-65%.

3. Subfloor

3. Subsuelo

3. Sous-sol



3.1 Measure humidity with a carbide hygrometer, max 2.5%.

3.1 Medir la humedad con un higrómetro de carburo Max 2,5%

3.1 Mesurer l'humidité avec un hygromètre de carbure. Maximum: 2,5%.

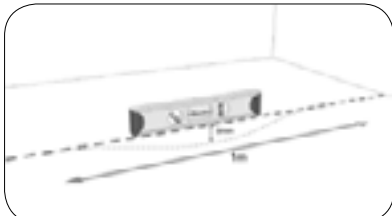

3.2 Flatness and horizontality: max. deflections admitted, 3mm and 1mm.

3.2 Planimetría y horizontalidad: se admite como max. flechas de 3mm y 1mm.

3.2 Planimétrie et horizontalité: des flèches d'un maximum de 3mm et 1mm sont admises.



3.3 Cleaning: clean base slab, and free from elements.

3.3 Limpieza: solera limpia y libre de elementos.

3.3 Nettoyage: lisse de terre propre et dépourvue d'éléments.



4. Direction of the installation: Boards arranged longitudinally in relation to the main light source.

4. Sentido de la instalación: lamas dispuestas en sentido longitudinal con respecto a la fuente de luz principal.

4. Sens de l'installation: lames disposées en sens longitudinal par rapport à la source de lumière principale.

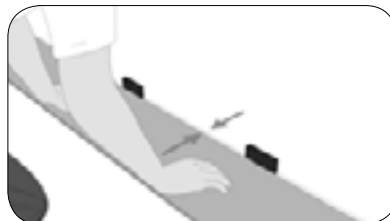

5. Planning the installation

5. Planificación de la instalación

5. Planification de l'installation

5.1 Perimeter joint: leave at least 10mm.

5.1 Junta perimetral: dejar como mínimo 10mm.

5.1 Joint périphérique: laisser minimum 10mm.

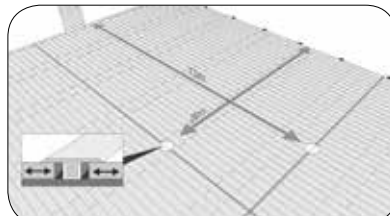

5.2 Expansion joints when the room exceeds 12 longitudinal meters and 8 meters across. Minimum width 15 mm. Where to install them: start of corridors, doorway areas, narrowing between partition walls that separate one single space...

5.2 Juntas de expansión cuando el local sobrepase 12m longitudinales y 8 metros transversales. Ancho mínimo 15mm. Lugares para colocar los arranques de pasillos, zonas de paso de puertas, estrechamientos entre tabiques que separan un mismo espacio...

5.2 Joints de dilatation lorsque la pièce dépasse les 12 m longitudinaux et 8 m transversaux. Largeur minimale : 15 mm. Lieux pour la mise en place des naissances des couloirs, des zones de passage des portes, des rétrécissements entre les cloisons qui séparent une même pièce.

5.3. To install with tongue and groove, glue the boards throughout their perimeter with our recommended white glue.

5.3 Para colocación con Machihembrado encolar las lamas en todo su perímetro con nuestra cola blanca recomendada.

5.3 Pour la pose en bouvetage, coller les lames sur tout leur périmètre avec notre colle blanche recommandée.

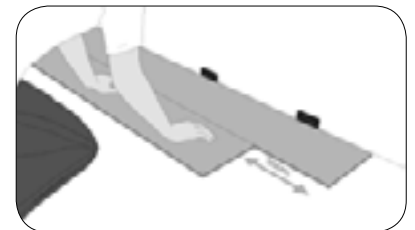

5.4 Offset: the installation shall advance so that the ends of each board are separated at least 30cm from the next one.

5.4 Decalaje: la colocación debe progresar de forma que los extremos de cada tabla queden separados respecto a la siguiente de 30cm.

5.4 Décalage: les extrémités de chaque planche soient séparées de 30cm par rapport à la suivante lors de la pose.



5.5 Skirting boards nailed to the wall using a pneumatic gun.

5.5 Zócalos clavados a la pared mediante pistola neumática.

5.5 Socles cloués au mur avec une cloueuse à air comprimé.

Installation / Instalación / Installation

INSTALLATION

INSTALACIÓN

INSTALLATION

6. Floating system

6. Sistema flotante

6. Système flottant



6.1. We recommend installing the L'Antic Colonial sheet, whether it is the moisture barrier+foam sheet or the antistatic radiant-floor film.

6.1 Se recomienda la instalación de la lámina de L'Antic Colonial. Ya sea la lámina anti-humedad+ espuma o la lámina de suelo radiante antiestática.

6.1 Il est recommandé d'installer la lame de L'Antic Colonial. Soit la lame anti-humidité + mousse, soit la lame de plancher rayonnant anti-statique.

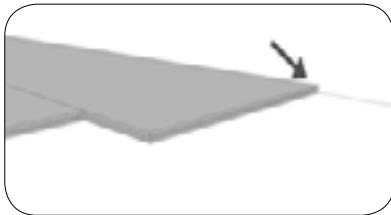

6.2 Start the installation with the female ends towards the wall, keeping the minimum distance of 10mm using wedges.

6.2 Iniciar con las hembras hacia la pared, con la distancia mínima de 10mm mediante cuñas.

6.2 Commencer avec les femelles vers le mur, avec une distance minimale de 10mm en utilisant des cales.

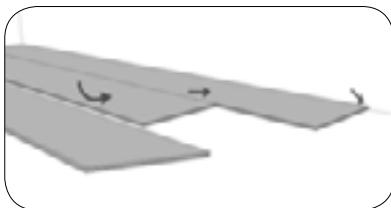

6.3 On the third board and the rest for the new rows, use the same installation method. The first rows have to be perfectly straight and be parallel. Check with the ruler.

6.3 En la tercera lama, y las siguientes para las nuevas hileras, efectuar la misma colocación. Las primeras hileras tienen que estar rigurosamente rectas y ser paralelas. Controlar con regla.

6.3 Vous devez effectuer la même pose à la troisième lame et les suivantes pour les files suivantes. Les premières files doivent être rigoureusement droites et être parallèles. Contrôler avec la règle.

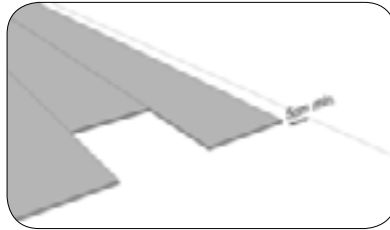

6.4 The width of the boards on the last row cannot be under 5cm.

6.4 El ancho de las lamas de la última hilera no debe ser inferior a 5cm.

6.4 La largeur des lames de la dernière file ne doit pas être inférieure à 5cm.

7. Glued

7. Pegada

7. Collée

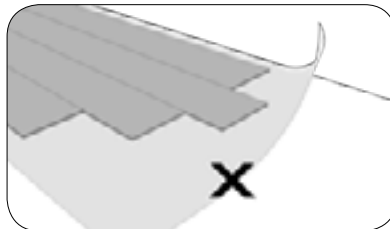

7.1. An insulation sheet is not required.

7.1. No es necesaria una lámina aislante.

7.1. Une lame isolante n'est pas nécessaire.

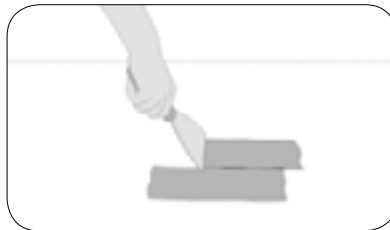

7.2 Apply the adhesive recommended by L'Antic: slc Flex, with a trowel with an adequate tooth depth, forming circles or seams. Apply a primer; we recommend Primer PU31 for absorbent substrates and Preparatore Pulep for non-absorbent substrates.

7.2 Aplicar el adhesivo recomendado por L'Antic: slc Flex, con espátula, de profundidad de diente adecuada, formando círculos o cordones. Aplicar una imprimación, recomendamos Primer PU31 para soportes absorbentes y Preparatore Pulep para soportes no absorbentes.

7.2 Appliquer l'adhésif recommandé par L'Antic Colonial : slc Flex, avec spatule, une profondeur de dent adéquate, en formant des cercles ou des cordons. Appliquer un apprêt, nous recommandons Primer PU31 pour des supports absorbants et Preparatore Pulep pour des supports non absorbants.

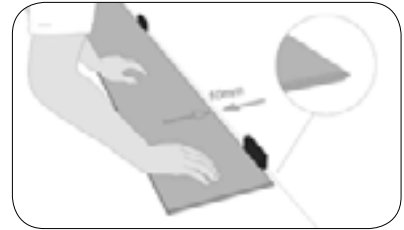

7.3 Glue the first row along the wall with the male side facing the wall, leaving an expansion joint of 10mm.

7.3 Pegar la primera fila a la pared con el macho mirando hacia esta, respetando la junta de dilatación de 10mm.

7.3 Coller la première file au mur avec le mâle en regardant vers celui-ci et en laissant un joint de dilatation de 10mm.

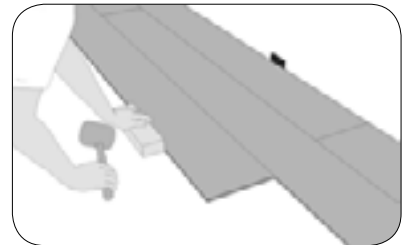

7.4 The rest of the row shall fit easily, joining male with female using a rubber hammer and a wood block.

7.4 El resto de hileras encajarán cómodamente, uniendo macho con hembra usando un martillo de goma y un bloque de madera.

7.4 Les autres files s'emboîteront facilement, en unissant le mâle à la femelle à l'aide d'un marteau en caoutchouc et un bloc en bois.

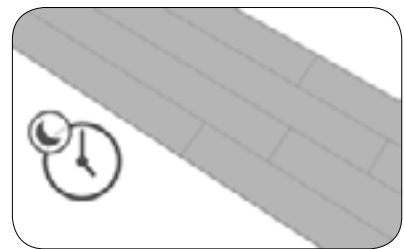

7.5 Install 3 or 4 rows and let them dry for at least one full night. They shall be the starting point the next day for installing the rest.

7.5 Colocar 3 o 4 filas y dejar secar al menos una noche completa. Punto de partida al siguiente día para instalar el resto.

7.5 Placer 3 ou 4 files et laisser sécher au moins une nuit entière. Point de départ le lendemain pour poursuivre l'installation.

8. Nailed

8. Clavada

8. Clouage

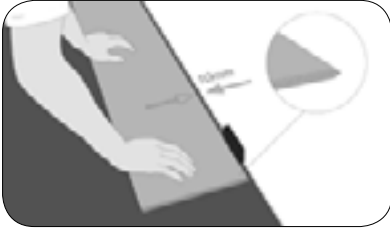

8.1 Install the first board with the male side facing the wall. Leave an expansion joint of 10mm.

8.1 Colocar la primera lama con el macho hacia la pared. Respetar junta de dilatación de 10mm.

8.1 Placer la première lame avec le mâle vers le mur. Laisser un joint de dilatation de 10 mm.



8.2 Install the first row by fixing on the male side, usually with flat head iron nails or staples. Install perfectly straight to prevent deviations from spreading.

8.2 Instalar la primera fila fijando el macho, normalmente con clavos de hierro de cabeza plana o grapas. Colocar perfectamente recta para evitar que la desviación se propague.

8.2 Installer la première file en fixant le mâle, normalement avec des clous en fer à tête plate ou des agrafes. La placer parfaitement droite pour éviter une propagation de la déviation.

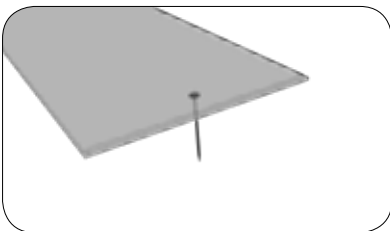

8.3 Nails shall be inserted perpendicular to the wood along its entire length in order to avoid problems of the floor elements fastening to each other.

8.3 Clavar perpendicularmente los clavos en la madera en toda su longitud para evitar problemas de fijación entre sí de los elementos del suelo.

8.3 Clouer les clous dans le bois perpendiculairement sur toute sa longueur pour éviter des problèmes de fixation entre les éléments du revêtement du sol.

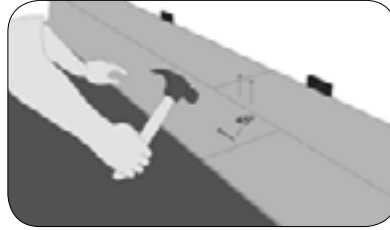

8.4 The second row of nails must be slanted at a 45°.

8.4 Introducir la segunda fila de clavos inclinados en un ángulo de 45°.

8.4 Introduire la deuxième file de clous inclinés à un angle de 45°.



8.5 Introduce the male side into the female side with the hammer until the joint for both boards is completely closed in the following rows.

8.5 Introducir el macho en la hembra con el martillo hasta que la junta de ambas lamas se haya cerrado totalmente en las filas sucesivas.

8.5 Introduire le mâle dans la femelle avec le marteau jusqu'à ce que le joint des deux lames soit complètement fermé dans les files suivantes.

8.6 Install all rows until reaching the last one, where the last row of nails is introduced perpendicularly.

8.6 Colocar todas las filas hasta llegar a la última donde la última fila de clavos se introduce de forma perpendicular.

8.6 Placer toutes les files jusqu'à la dernière, où la dernière file de clous est introduite perpendiculairement.

9. Radiant floor heating

9. Suelo radiante

9. Plancher rayonnant

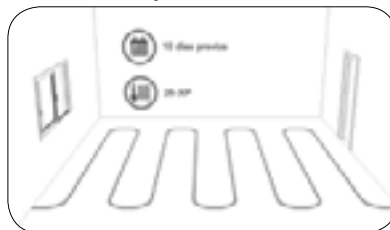

9.1 Turn on the radiant system to 25-30°C, 10 days before installing.

9.1 Los 10 días previos a la instalación, encender el sistema radiante a 25-30°C.

9.1 Pendant les 10 jours préalables à la pose, allumer le système de chauffage rayonnant à une température de 25-30°C.

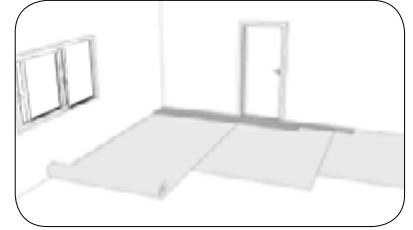

9.2. We recommend installing the L'Antic Colonial antistatic radiant floor film.

9.2 Se recomienda la instalación de la lámina para suelo radiante antiestática de L'Antic Colonial.

9.2 Il est recommandé d'installer la lame pour plancher rayonnant anti-statique de L'Antic Colonial.



9.3 Once it is installed, increase the temperature 2-3°C per day up to the maximum.

9.3 Una vez instalado incrementar la Tª 2- 3°C al día hasta llegar al máximo.

9.3 Après l'installation, augmenter la température entre 2 et 3°C chaque jour jusqu'à atteindre la température maximale.



9.4 Once the max temperature is reached, it must be maintained one day per cm of thickness of the sub-floor (overnight).

9.4 Una vez alcanzada la Tª max mantener un día por cada cm de espesor del subsuelo (por la noche).

9.4 Dès que la température maximale est atteinte, la maintenir une journée pour chaque centimètre d'épaisseur du sous-sol (la nuit).



9.5 Lastly, the temperature must be lowered 2-3°C until the floor reaches 15°C (about 10 days.)

9.5 Por último disminuir la Tª 2-3°C hasta que el suelo alcance los 15°C (unos 10 días).

Installation / Instalación / Installation

9.5 Finalement, diminuer la température entre 2 et 3°C jusqu'à ce que la température du sol arrive à 15°C (environ 10 jours).

IMPORTANT

IMPORTANTE

IMPORTANT

Right after installing and before the first use, we recommend using Clean & Green Aqua Oil 1 L for our Natur and Natur Plus finishes.

Justo después de la instalación y antes del primer uso recomendamos la utilización de Clean & Green Aqua Oil 1L para nuestros acabados Natur y Natur Plus.

Dès que l'installation est finie et avant le premier usage, nous recommandons d'utiliser Clean & Green Aqua Oil 1L pour les finitions Natur et Natur Plus.

You can see these updated installation instructions by visiting our website www.anticcolonial.com

Puedes revisar estas instrucciones de instalación actualizadas y con más detalle visitando nuestra página web www.anticcolonial.com

Pour réviser ces instructions d'installation, mises à jour et plus détaillées, veuillez visiter notre site Internet www.anticcolonial.com



Wall Flooring Advance 1L Warm Oak



Floor Coverings Authentic 1L Anthracite

06



Floor Coverings Styledeck Plus Brown

Outdoor Decking

All L'Antic Colonial outdoor decking may be subject to variations in shade. The colour of the material supplied may differ slightly from that shown. Our website (<http://anticcolonial.com/en/outdoor-decking/>) contains further information in respect of our outdoor decking, such as installation guides and videos, technical specifications, details on textures or recommendations for use.

La tarima de exterior de L'Antic Colonial pueden sufrir variaciones de tono. El color del material servido puede no ser exactamente igual al de la muestra. En nuestra página web (<http://anticcolonial.com/tarima-exterior/>) encontrará información adicional de nuestra tarima de exterior como guías y vídeos de instalación, fichas técnicas, texturas o recomendaciones de uso.

Le plancher extérieur de L'Antic Colonial peut subir des variations de tonalité. La couleur du matériau fourni peut être légèrement différente de celle de l'échantillon. Sur notre site Internet (<http://anticcolonial.com/fr/plancher-exterieur/>), vous trouverez des informations supplémentaires sur notre plancher extérieur : manuels et vidéos d'installations, fiches techniques, textures ou recommandations d'utilisation.

Styledeck Plus

—
Dark
Grey
Brown

Outdoor Decking





Styledeck Plus Dark

Description	Format	Codes	Group	Pcs	m2	Kg
Kit Styledeck Plus Dark*	-	100153494 L167012473	G-263	-	-	-
Styledeck Plus Dark	14,4x210x2,2cm 5 5/8"x82 6/8"x7/8"	100153496 L167012474	G-252	3 x Cj 120 x Pal	1,90 x Cj 76,20 x Pal	9,90 x Cj 396 x Pal
Rastrel Pino	4,5x3,8x210cm 1 3/4"x1 1/2"x82 5/8"	100156133 L167012498	G-121	1 x Cj 504 x Cj	0,09 x Cj 47,37 x Pal	1,99 x Cj 1002,45 x Pal
Clips Styledeck Plus	-	100155280 L167012494	G-166	450 x Cj 90000 x Pal	-	4,50 x Cj 900 x Pal

*The kit includes the following for every 1m² / *Por cada 1m² tarima el Kit incluye / Pour chaque mètre carré, le Kit inclut:*
 -1 m² of decking / 1 m² de tarima / 1 m² de plancher.
 -4 m of joists / 4 ML de rastrel / 4 mètres linéaires de lambourdes.
 -27 clips with screws / 27 Clips con tornillos / 27 attaches avec vis.



Styledeck Plus Grey

Description	Format	Codes	Group	Pcs	m2	Kg
Kit Styledeck Plus Grey*	-	100153520 L167012470	G-263	-	-	-
Styledeck Plus Grey	14,4x210x2,2cm 5 5/8"x82 6/8"x7/8"	100153497 L167012475	G-252	3 x Cj 120 x Pal	1,90 x Cj 76,20 x Pal	9,90 x Cj 396 x Pal
Rastrel Pino	4,5x3,8x210cm 1 3/4"x1 1/2"x82 5/8"	100156133 L167012498	G-121	1 x Cj 504 x Cj	0,09 x Cj 47,37 x Pal	1,99 x Cj 1002,45 x Pal
Clips Styledeck Plus	-	100155280 L167012494	G-166	450 x Cj 90000 x Pal	-	4,50 x Cj 900 x Pal

*The kit includes the following for every 1m² / *Por cada 1m² tarima el Kit incluye / Pour chaque mètre carré, le Kit inclut:*
 -1 m² of decking / 1 m² de tarima / 1 m² de plancher.
 -4 m of joists / 4 ML de rastrel / 4 mètres linéaires de lambourdes.
 -27 clips with screws / 27 Clips con tornillos / 27 attaches avec vis.

Styledeck Plus



Styledeck Plus Brown

Description	Format	Codes	Group	Pcs	m2	Kg
Kit Styledeck Plus Brown*	-	100153493 L167012471	G-263	-	-	-
Styledeck Plus Brown	14.4x210x2.2cm 5 5/8"x82 6/8"x7/8"	100153495 L167012472	G-252	3 x Cj 120 x Pal	1,90 x Cj 76,20 x Pal	9,90 x Cj 396 x Pal
Rastrel Pino	4,5x3,8x210cm 1 3/4"x1 1/2"x82 5/8"	100156133 L167012498	G-121	1 x Cj 504 x Cj	0,09 x Cj 47,37 x Pal	1,99 x Cj 1002,45 x Pal
Clips Styledeck Plus	-	100155280 L167012494	G-166	450 x Cj 90000 x Pal	-	4,50 x Cj 900 x Pal

*The kit includes the following for every 1m² / *Par cada 1m² tarima el Kit incluye / Pour chaque mètre carré, le Kit inclut:*
 -1 m² of decking / 1 m² de tarima / 1 m² de plancher.
 -4 m of joists / 4 ML de rastrel / 4 mètres linéaires de lambourdes.
 -27 clips with screws / 27 Clips con tornillos / 27 attaches avec vis.



Floor Coverings Styledeck Plus Brown

BEFORE INSTALLING
 ANTES DE LA INSTALACIÓN
 AVANT L'INSTALLATION

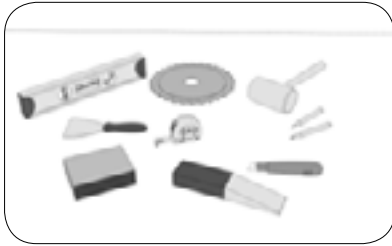

Tools: circular saw, wedges, pegs, rubber hammer, measuring tape, ruler, and pencil.

Herramientas: sierra circular, cuñas, tacos, martillo de goma, metro, regla y lápiz.

Outils: scie circulaire, cales, chevilles, marteau en caoutchouc, mètre, règle et crayon.

Installing the battens
 Colocación de los rastreles
 Pose des tasseaux

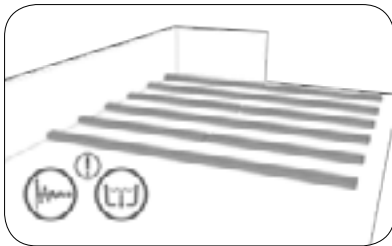

The lower structural supports or battens must rest on a stable base that has the necessary slope for water drainage.

Los apoyos estructurales inferiores o rastreles, deben descansar sobre una base estable y con pendiente para el drenaje del agua.

Les soutiens structurels inférieurs ou tasseaux doivent être posés sur une base stable ayant une pente pour le drainage de l'eau.

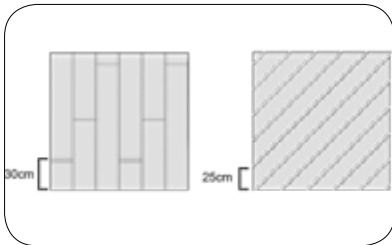

Maximum spacing between centers:
 30 cm for residential use.
 25 cm for public use applications.

Separación máxima entre centros de: 30cm para aplicaciones residenciales. 25cm para aplicaciones de uso público.

Séparation maximale entre les centres de: 30 cm pour des applications résidentielles. 25 cm pour des applications d'usage public.

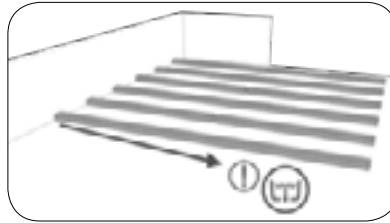

Install parallel to the slope direction.
Instalar paralelamente a la dirección de la "caída" de las aguas.

Installation en parallèle à la direction de «chute» des eaux.

Profiles
 Perfiles
 Profilés

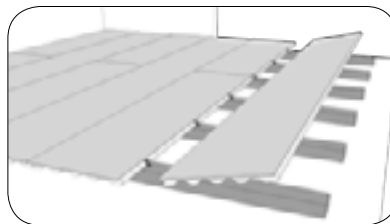

The ends shall rest on battens and be attached to them with the included clip, to avoid any possibility of deformation from weight and bending of the wood flooring.

Los extremos deben descansar sobre rastreles y fijarse a estos mediante la grapa que viene incluida para eliminar toda posibilidad de deformación por el peso y la flexión de la tarima.

Les extrémités doivent être posées sur des tasseaux et fixées avec l'agrafe qui est incluse pour éliminer les éventuelles déformations provoquées par le poids et la flexion du plancher.

Spacing
 Separación
 Séparation

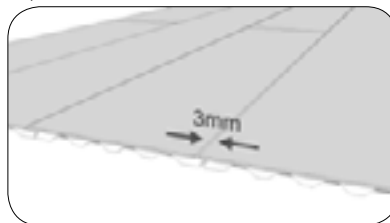

3mm between profiles to allow drainage and ventilation.

3mm entre perfiles para permitir el drenaje y la ventilación.

Laisser 3mm entre les profils pour permettre le drainage et l'aération.

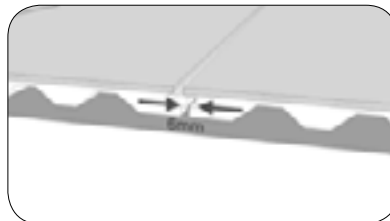

6 to 8mm separation joint between the profile heads.

Junta de separación entre las testas de los perfiles de 6 a 8mm.

Joint de séparation entre les têtes des profilés de 6 à 8mm.

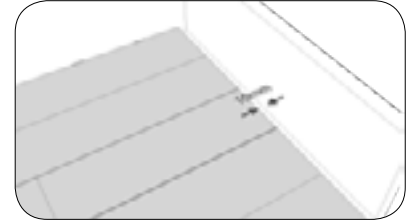

If it is perpendicular to the wall, leave a 10mm separation between the wall and the deck.

En montaje perpendicular a la pared, dejar 10mm entre esta y la tarima.

Pour le montage perpendiculaire au mur, laisser 10mm entre le mur et le plancher.

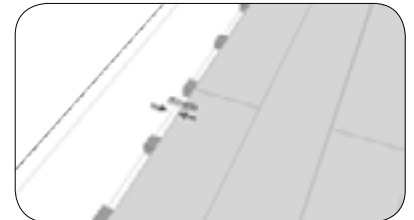

If it is to be mounted parallel to the wall, leave a 5mm space.

En montaje paralelo a la pared, dejar un margen de 5mm.

Pour le montage parallèle au mur, laisser une marge de 5mm.

Fastening
 Fijación
 Fixation

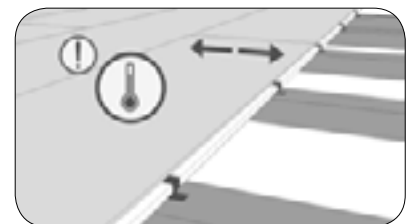

Fasten the profiles with clips, allowing for their movement during thermal expansion.

Fijar los perfiles con grapas, permitiendo el movimiento de estos durante la acción de dilatación térmica.

Fixer les profilés avec les agrafes, pour permettre leur mouvement lors de la dilatation thermique.



Installation / Instalación / Installation

Use 20 to 25 clips per square meter.

Usar de 20-25 grapas por metro cuadrado.

Utiliser entre 20 et 25 agrafes par mètre carré.

Deck finishing

Acabado de la terraza

Finition de la terrasse

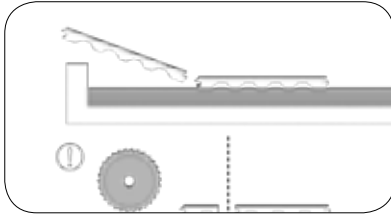

Level the ends of the profiles forming the deck using a circular saw and a ruler.

Igualar el final de los perfiles que forman la tarima usando una sierra circular y una regla.

Égaliser la finition des profilés qui forment le plancher à l'aide de la scie circulaire et la règle.

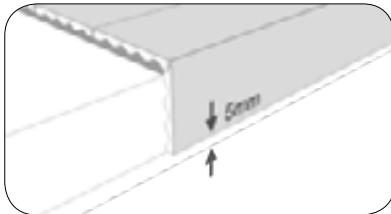

Distance of 5mm between the skirt and the base to allow the deck to ventilate.

Distancia de 5mm entre la falda y el suelo para permitir la ventilación de la tarima.

Distance de 5mm entre la jupe et le sol pour permettre l'aération du plancher.

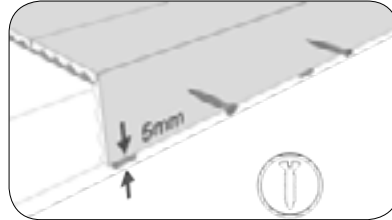

Fasten the skirt to the battens using stainless steel screws, leaving a 5mm space between the profile and the skirting board.

Fijar la falda a los rastreles mediante tornillos de acero inoxidable, dejando una separación de 5mm entre el perfil y el friso.

Fixer la jupe aux tasseaux avec des vis en acier inoxydable, en laissant une séparation de 5mm entre le profilé et la frise.

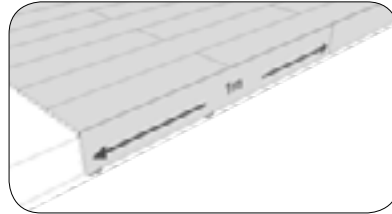

We recommend using short length (1m) profile sections for making the skirt.

Se recomienda usar secciones de perfil de poca longitud, 1m, para realizar la falda.

Il est recommandé d'utiliser des sections de profilé de faible longueur (1m) pour réaliser la jupe.

You can see these updated installation instructions by visiting our website www.anticcolonial.com

Puedes revisar estas instrucciones de instalación actualizadas y con más detalle visitando nuestra página web www.anticcolonial.com

Pour réviser ces instructions d'installation, mises à jour et plus détaillées, veuillez visiter notre site Internet www.anticcolonial.com



Floor Coverings Styledeck Plus Brown

07



Laminate Flooring

All L'Antic Colonial laminates may be subject to variations in shade. The colour of the material supplied may differ slightly from that shown. Our website (<http://anticcolonial.com/en/laminate-flooring/>) contains further information in respect of our products, such as installation guides and videos, technical specifications, details on textures, recommendations for use and maintenance.

Todos los laminados de L'Antic Colonial pueden sufrir variaciones de tono. El color del material servido puede no ser exactamente igual al de la muestra. En nuestra página web (<http://anticcolonial.com/suelo-laminado/>) encontrará información adicional de nuestros productos como guías y vídeos de instalación, fichas técnicas, consejos para su mantenimiento, texturas o recomendaciones de uso.

Tous les stratifiés de L'Antic Colonial peuvent subir des variations de tonalité. La couleur du matériau fourni peut être légèrement différente de celle de l'échantillon. Sur notre site Internet (<http://anticcolonial.com/fr/stratifie/>), vous trouverez des informations supplémentaires sur nos produits : manuels et vidéos d'installations, fiches techniques, conseils pour l'entretien, textures ou recommandations d'utilisation.

**NATURAL**

Simulation of lightly textured wood in a wide range of colours.

Simulación a madera ligeramente cepillada con una gran gama cromática.

Imite le bois légèrement raboté dans une large gamme chromatique.

**SUPREME**

High performance, wide format natural wood effect laminate flooring.

Cualidades de laminado con formato de madera natural de una lama ancha.

Qualités du stratifié au format d'une lame large de bois naturel.

**RESIDENCE**

Contemporary colours with elegant designs.

Colores actuales con diseños elegantes.

Couleurs actuelles, designs élégants.

**STYLE**

Synchronised designs and textures with a contemporary touch.

Diseños y relieves sincronizados con tonos de actualidad.

Design et reliefs synchronisés sur tons actuels.

Collections / Colecciones / Collections



REVELATION

Extremely durable, with avant garde designs and colours.

Gran resistencia con diseños y colores vanguardistas.

Grande résistance, designs et couleurs avant-gardistes.



ENDLESS

Natural finishes with effect of continuity between boards.

Acabados Natural con efecto continuo entre las lamas.

Finition Natural, effet continu entre lames.



GENUINE

Superior quality wood-effect decorative film with wide shade variations.

Gran calidad de película decorativa que simula madera con una alta destonificación.

Film décoratif de grande qualité qui imite le bois avec un délavage très prononcé.



QUERCUS

Laminated in size 15.9x138.3x0.8cm with a natural finish where knots are the main feature thanks to its design and texture

Laminado de formato 15,9x138,3x0,8cm que cuenta con un acabado natural donde los nudos son los protagonistas gracias a su dibujo y textura.

Laminé au format 15,9x138,3x0,8 cm avec une finition naturelle qui souligne les nœuds à travers le dessin et la texture.

07 Description of Finishes / Descripción Acabados / Description Finitions



LIFE

Laminate with texture similar to brushed wood.
Laminado con textura similar a la madera cepillada.
Stratifié dont la texture est semblable à celle du bois brossé.



BEVEL 4

Beveled cut on all 4 edges of the board in order to emphasize its size.

BISEL 4
Corte oblicuo en los 4 bordes de las lamas para resaltar el tamaño.

BISEAU 4
Coupe oblique sur les 4 bords des lames pour mettre en valeur la dimension.



BEVEL 2

Beveled cut on the long sides of the board in order to create a continuity effect.

BISEL 2
Corte oblicuo en los lados largos de las lamas para crear efecto de continuidad.

BISEAU 2
Coupe oblique sur la longueur des lames pour créer des effets de continuité.



MATT

Gloss-free laminate.

MATE
Laminado que carece de Brillo.

MAT
Stratifié non brillant.

Description of Finishes / Descripción Acabados / Description Finitions



TEXTURE

Laminate with texture similar to hand-smoothed wood.

TEXTURA

Laminado con textura similar a la madera desbastada a mano.

TEXTURE

Stratifié dont la texture est semblable à celle du bois dégrossi manuellement.



NATURAL

Laminate that imitates the surface of the wood.

NATURAL

Laminado que imita la superficie de la madera.

NATUREL

Stratifié qui imite la surface du bois.



SENSE & SENSE PLUS

Laminate which has a microstructured surface that is similar to that of natural wood pores. It gives the material a feel that is similar to wood, increased in relation to the Sense version.

Laminado que cuenta con una superficie microestructurada similar los poros de la madera natural. Otorga al material un tacto similar al de madera incrementado con respecto a la versión Sense.

Stratifié qui présente une surface microstructurée semblable à celle des pores du bois naturel. Il donne au matériau un toucher semblable à celui du bois, plus prononcé par rapport à la version Sense.

07 Key to Symbols / Descripción Iconos / Description des Symboles



20 YEAR WARRANTY

Quality product made of selected raw materials, guaranteeing its full performance in residential private use for 20 years in AC4 and AC5 models.

GARANTÍA 20 AÑOS

Producto de calidad, elaborado con materias primas seleccionadas, garantizando su uso pleno en vivienda por 20 años en los modelos AC4 y AC5 de uso privado.

GARANTIE 20 ANS

Produit de qualité élaboré avec des matières premières de choix, avec une garantie de 20 ans d'utilisation en logement privé sur les modèles AC4 et AC5.



5 YEAR WARRANTY

Quality product made of selected raw materials, guaranteeing its full performance for 5 years in the AC5 models for public use.

GARANTÍA 5 AÑOS

Producto de calidad, elaborado con materias primas seleccionadas, garantizando su uso pleno por 5 años en los modelos AC5 de uso público.

GARANTIE 5 ANS

Produit de qualité élaboré avec des matières premières de choix, avec une garantie de 5 ans sur les modèles AC5 d'utilisation publique.



FLOATING INSTALLATION

Installation system in which it is not necessary to glue the boards to the floor. They are installed on a foam and joined together.

INSTALACIÓN FLOTANTE

Sistema de instalación en el que no es necesario encolar las tablas al suelo. Se colocan sobre un foam unidas entre si.

SYSTÈME FLOTTANT

Système d'installation où il n'est pas nécessaire de coller les planches au sol. Elles doivent être posées sur une mousse, assemblées entre elles.



1 BOARD

Laminate format where only one board has been used to finish the entire base surface.

1 LAMA

Formato de laminado en el que se ha utilizado solo una tabla para completar toda la superficie de la base.

1 LAME

Format de stratifié où n'a été utilisée qu'une seule planche pour compléter toute la surface de la base.



2 BOARDS

Laminate format where the decorative layer has been divided into two smaller slats for finishing the base surface.

2 LAMAS

Formato de laminado en el que la capa decorativa se ha dividido en dos lamas de menor tamaño para completar la superficie de la base.

2 LAMES

Format de stratifié où la couche décorative a été divisée en deux lames plus petites pour compléter la surface de la base.



3 BOARDS

Laminate format where the decorative layer has been divided into three smaller slats for finishing the base surface.

3 LAMAS

Formato de laminado en el que la capa decorativa se ha dividido en tres lamas de menor tamaño para completar la superficie de la base.

3 LAMES

Format de stratifié où la couche décorative a été divisée en trois lames plus petites pour compléter la surface de la base.



SUITABLE RADIANT WATER FLOOR HEATING

Laminate that is suitable for installing on radiant water floor heating.

APTO CALEFACCIÓN RADIANTE POR AGUA

Laminado apto para su instalación sobre calefacción radiante por agua.

ADAPTÉ À UN PLANCHER CHAUFFANT À EAU

Stratifié adapté à une installation sur un sol chauffant à l'eau.



ENDLESS

Boards that have continuity between them, thus achieving the optical effect of much longer formats.

Lamas que tienen continuidad entre ellas, consiguiendo así un efecto óptico de formatos mucho más largos.

Lames continues qui présentent une continuité entre elles, ce qui permet d'obtenir un effet d'optique de formats beaucoup plus longs.



ANTI-STATIC FLOOR

Floor capable of dissipating excess electrical charges and spread them over the entire surface.

SUELO ANTIESTÁTICO

Suelo capaz de disipar los excesos de cargas eléctricas y repartirlos por toda la superficie.

SOL ANTISTATIQUE

Sol en mesure de dissiper les excès de charges électriques et de les répartir sur toute la surface.



AC4 ABRASION RESISTANCE LEVEL

Abrasion-resistance level as per Standard UNE-EN 13329.

NIVEL RESISTENCIA A LA ABRASIÓN AC4

Nivel de resistencia a la abrasión según norma UNE-EN 13329.

NIVEAU DE RÉSISTANCE À L'ABRASION AC4

Niveau de résistance à l'abrasion, conformément à la norme UNE-EN 13329.



AC5 ABRASION RESISTANCE LEVEL

Abrasion-resistance level as per Standard UNE-EN 13329.

NIVEL RESISTENCIA A LA ABRASIÓN AC5

Nivel de resistencia a la abrasión según norma UNE-EN 13329.

NIVEAU DE RÉSISTANCE À L'ABRASION AC5

Niveau de résistance à l'abrasion, conformément à la norme UNE-EN 13329.



FSC® CERTIFICATE

Independent (non-governmental) certificate that warrants to the consumer that forest products originate from rationally-used forests.

CERTIFICADO FSC®

Certificado independiente (no gubernamental) que garantiza al consumidor que los productos forestales proceden de montes aprovechados de forma racional.

CERTIFICAT FSC®

Certificat indépendant (non gouvernemental) qui garantit au consommateur que les produits forestiers proviennent de montagnes exploitées de façon rationnelle.



PEFC CERTIFIED

PanEuropean Forest Certification that warrants the consumer the origin of the products from sustainably managed forests.

CERTIFICADO PEFC

Certificación Forestal Paneuropea que garantiza al consumidor la procedencia de los productos de masas forestales gestionadas de forma sostenible.

CERTIFICAT PEFC

Certification forestière paneuropéenne qui garantit au consommateur que les produits proviennent de forêts gérées de façon durable.

Composition / Composición / Composition

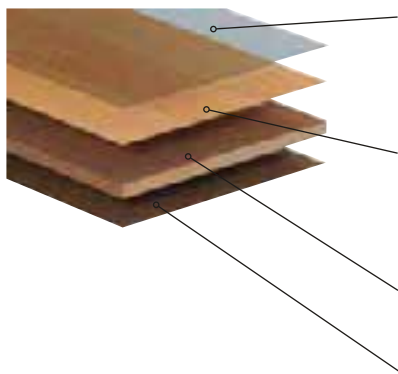

- C1. Protective upper layer (overlay).** Clear cellulose paper impregnated with melamine resin and aluminium dioxide and corundum particles.
Capa superior protectora (overlay). Papel de celulosa transparente impregnada con resina melamínica y partículas de dióxido de aluminio y corindón.
Couche de protection supérieure (overlay). Feuille de cellulose transparente imprégnée de résine de mélamine et de particules de dioxyde d'aluminium et corindon.
- C2. Decorative layer.** High-resolution printed paper impregnated with aminoplast resins. Some models also have 2 extra specially impregnated layers.
Laminado decorativo. Papel impreso de alta definición impregnado en resinas aminoplásticas. Algunos modelos llevan además 2 capas de estrazas especialmente impregnadas.
Film décoratif. Papier imprimé haute définition imprégné de résines aminoplastiques. Certains modèles comportent également 2 couches de papier kraft spécialement imprégné.
- C3. Core layer.** High density fibreboard (HDF) and water-repellent glues. 7-10mm.
Placa base. Tablero de fibra de alta densidad (HDF) y colas hidrófugas. 7-10mm.
Plaque de base. Panneau en bre haute densité (HDF) et colles hydrofuges. 7-10 mm.
- C4. Balancing layer.** Sheet of Kraft paper impregnated with various layers of resins.
Lamina de contracción. Hoja de papel kraft impregnado con resinas en varias capas.
Stratié de contraction. Feuille en papier kraft imprégnée de plusieurs couches de résines.

Installation Systems / Sistemas de Instalación / Systèmes de Pose



QUICK LOCK



1. Fit Together
Encajar
Emboîtement



2. Press Into Place
Presionar
Compression



3. Ready
Listo
Et Voilà

- Tool-free installation system. / *Montaje sin herramientas. / Montage sans outils.*
- Very quick to lay. / *Muy rápida instalación. / Installation très rapide.*
- Professional end results. / *Acabado profesional. / Finition professionnelle.*
- Easy to lay and just as easy to take up. / *Tan sencillo de instalar como de desinstalar. / Aussi simple à poser qu'à retirer.*
- Secure locking system on all four sides of the boards. / *Uniones seguras en los cuatro lados de las lamas. / Unions sûres sur les quatre côtés des lames.*
- Can be bonded to the floor. / *Se puede pegar al suelo / Le produit peut être collé sur le sol.*

One of the easiest, most secure installation systems on the market. Just angle boards against the long side of the previously fitted one and press down gently. No tools are needed. The boards will lock into place and remain firmly secure, thanks to the tongue and groove system. The flooring is just as swift and easy to take up.

Es uno de los sistemas de más fácil instalación y seguro del mercado. Tan sólo se tiene que ajustar la lama que se va a instalar en sentido longitudinal a la ya colocada ejercer una suave presión sin ningún tipo de herramienta. Las dos piezas encajarán y quedarán sujetas gracias a la lengüeta de seguridad. Su desinstalación es igual de sencilla, lo que permite que sea desmontado rápidamente.

Système parmi les plus simples à poser et les plus sûrs du marché. Il suffit de positionner la lame à installer dans le sens de la longueur contre une lame déjà posée et d'exercer une légère pression sans aucun type d'outillage. Les deux pièces s'emboîtent et restent unies grâce à une languette de sécurité. Le démontage est tout aussi simple, ce qui permet un retrait rapide.



LOCK



1. Tip
Inclinar
Inclinaison



2. Fit Together
Encajar
Emboîtement



3. Press Into Place
Presionar
Compression



4. Ready
Listo
Et Voilà

One of the main features of this easy-to-install system is the long-lasting secure locking mechanism, ensuring that no gaps appear between the boards during the floor's useful life. Pressure is exerted on the boards when fitted, locking them securely into place and preventing them from being wrongly aligned.

La seguridad y la durabilidad de unión entre juntas son las principales características de este sistema de fácil instalación que garantiza la eliminación de las rendijas entre las lamas durante toda la vida útil del suelo. La presión que se ejerce entre las lamas refuerza la unión e impide que ésta no se realice de forma incorrecta.

La sécurité et la durabilité du raccord entre les planches constituent les principales caractéristiques de ce système facile à poser qui garantit l'élimination de fentes entre les planches tout au long de la vie utile du revêtement de sol. La pression exercée entre les planches renforce leur assemblage et empêche toute erreur de pose.



Supreme 24,3x220cm - 9 5/8"x96 5/8"



Quercus 15,9x138,3cm - 6 1/4"x54 1/2"x3/8"

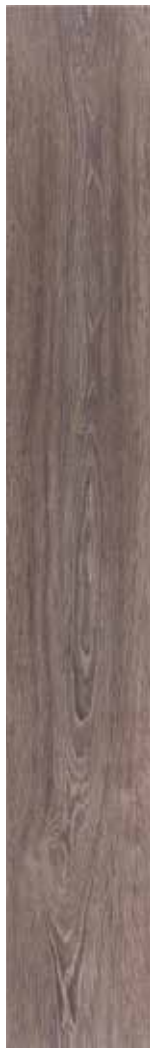

Residence 19,3x138cm - 7 5/8"x54 3/8"



Revelation 16x128,7cm - 6 1/4"x50 5/8"



1 Lama 19,3x128,2cm - 7 5/8"x50 1/2"

Formats / Formatos / Formats



2 Lamas 19,3x128,2cm - 7 5/8"x50 1/2"



3 Lamas 19,3x128,2cm - 7 5/8"x50 1/2"



Endless 24,4x126,1cm - 9 5/8"x49 5/8"

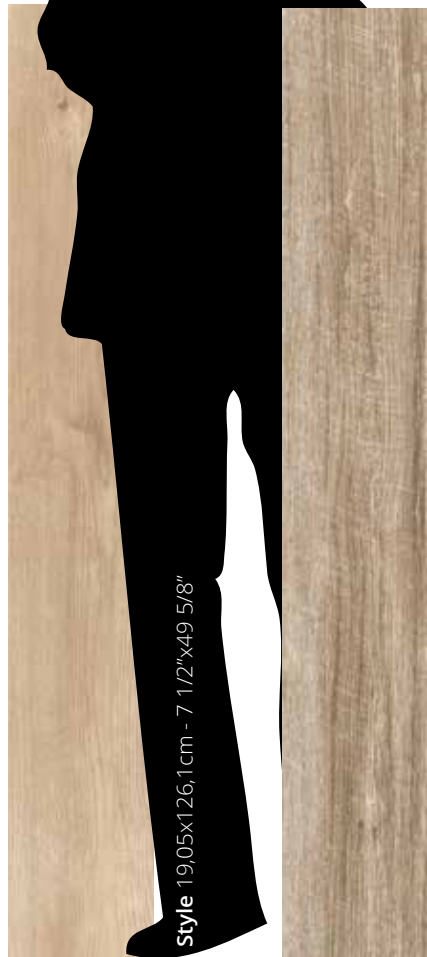

Style 19,05x126,1cm - 7 1/2"x49 5/8"

Genuine 19x125,7cm - 7 5/8"x54 3/8"

Natural

—
Ebano
Texas
Loft

Marron Decape
Amazon Light
Michigan Brown
Roble Life
Michigan Clear





Natural 1L
Ebano



Description	Format	Codes	Group	Pcs	m2	Kg
AC4 Natural 1L Ebano	19,3x128,2x0,8cm	100086949	G-207	8 x Cj	1,98 x Cj	16,42 x Cj
	7 5/8"x50 1/2"x5/16"	L163122088		416 x Pal	102,75 x Pal	853,63 x Pal
Skirting / Zócalo / Plinthe	8x220x1,5cm	100155445	G-107	14 x Cj	2,46 x Cj	19,32 x Cj
	3 1/8"x86 5/8"x5/8"	L165003249		560 x Pal	98,56 x Pal	772,80 x Pal
Transition Profile / Perfil Transición / Profilé Jointoiment	4x270x1cm	100168396	G-155	20 x Cj	2,16 x Cj	15,92 x Cj
	1 3/4"x106 1/4"x3/8"	L165003541		1000 x Pal	108,00 x Pal	796 x Pal
Levelling Profile / Perfil Igualación / Profilé Égalisation	4x270x1cm	100168422	G-155	20 x Cj	2,16 x Cj	15,92 x Cj
	1 3/4"x106 1/4"x3/8"	L165003542		1000 x Pal	108,00 x Pal	796 x Pal
Stair Nosing / Mampierlan / Nez de Marche	120x7x3cm	100176721	G-163	2 x Cj	0,17 x Cj	3,28 x Cj
	47 1/4"x2 3/4"x1 1/8"	L165003697		200 x Pal	16,80 x Pal	327,80 x Pal



Natural 1L
Texas

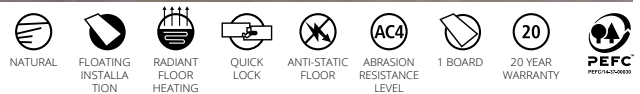

Description	Format	Codes	Group	Pcs	m2	Kg
AC4 Natural 1L Texas	19,3x128,2x0,8cm	100080783	G-207	8 x Cj	1,98 x Cj	15,86 x Cj
	7 5/8"x50 1/2"x5/16"	L163341451		416 x Pal	102,93 x Pal	824,93 x Pal
Skirting / Zócalo / Plinthe	8x220x1,5cm	100155450	G-107	14 x Cj	2,46 x Cj	19,32 x Cj
	3 1/8"x86 5/8"x5/8"	L165003235		560 x Pal	98,56 x Pal	772,80 x Pal
Transition Profile / Perfil Transición / Profilé Jointoiment	4x270x1cm	100164862	G-155	20 x Cj	2,16 x Cj	15,92 x Cj
	1 3/4"x106 1/4"x3/8"	L165003486		1000 x Pal	108,00 x Pal	796 x Pal
Levelling Profile / Perfil Igualación / Profilé Égalisation	4x270x1cm	100164842	G-155	20 x Cj	2,16 x Cj	15,92 x Cj
	1 3/4"x106 1/4"x3/8"	L165003485		1000 x Pal	108,00 x Pal	796 x Pal
Stair Nosing / Mampierlan / Nez de Marche	120x7x3cm	100176714	G-163	2 x Cj	0,17 x Cj	3,28 x Cj
	47 1/4"x2 3/4"x1 1/8"	L165003701		200 x Pal	16,80 x Pal	327,80 x Pal

Natural



Natural 1L Loft



Description	Format	Codes	Group	Pcs	m2	Kg
AC4 Natural 1L Loft	19,3x128,2x0,8cm	100086956	G-207	8 x Cj	1,98 x Cj	16,42 x Cj
	7 5/8"x50 1/2"x5/16"	L163122092		416 x Pal	102,75 x Pal	853,63 x Pal
Skirting / Zócalo / Plinthe	8x220x1,5cm	100155447	G-107	14 x Cj	2,46 x Cj	19,32 x Cj
	3 1/8"x86 5/8"x5/8"	L165003234		560 x Pal	98,56 x Pal	772,80 x Pal
Transition Profile / Perfil Transición / Profilé Jointolement	4x270x1cm	100160337	G-155	20 x Cj	2,16 x Cj	15,92 x Cj
	1 3/4"x106 1/4"x3/8"	L165003455		1000 x Pal	108,00 x Pal	796 x Pal
Levelling Profile / Perfil Igualación / Profilé Égalisation	4x270x1cm	100160334	G-155	20 x Cj	2,16 x Cj	15,92 x Cj
	1 3/4"x106 1/4"x3/8"	L165003454		1000 x Pal	108,00 x Pal	796 x Pal
Stair Nosing / Mampelran / Nez de Marche	120x7x3cm	100176722	G-163	2 x Cj	0,17 x Cj	3,28 x Cj
	47 1/4"x2 3/4"x1 1/8"	L165003702		200 x Pal	16,80 x Pal	327,80 x Pal



Natural 1L Marron Decape



Description	Format	Codes	Group	Pcs	m2	Kg
AC4 Natural 1L Marron Decape	19,3x128,2x0,8cm	100086951	G-207	8 x Cj	1,98 x Cj	16,42 x Cj
	7 5/8"x50 1/2"x5/16"	L163122090		416 x Pal	102,75 x Pal	853,63 x Pal
Skirting / Zócalo / Plinthe	8x220x1,5cm	100155448	G-107	14 x Cj	2,46 x Cj	19,32 x Cj
	3 1/8"x86 5/8"x5/8"	L165003237		560 x Pal	98,56 x Pal	772,80 x Pal
Transition Profile / Perfil Transición / Profilé Jointolement	4x270x1cm	100164825	G-155	20 x Cj	2,16 x Cj	15,92 x Cj
	1 3/4"x106 1/4"x3/8"	L165003475		1000 x Pal	108,00 x Pal	796 x Pal
Levelling Profile / Perfil Igualación / Profilé Égalisation	4x270x1cm	100164813	G-155	20 x Cj	2,16 x Cj	15,92 x Cj
	1 3/4"x106 1/4"x3/8"	L165003464		1000 x Pal	108,00 x Pal	796 x Pal
Stair Nosing / Mampelran / Nez de Marche	120x7x3cm	100176713	G-163	2 x Cj	0,17 x Cj	3,28 x Cj
	47 1/4"x2 3/4"x1 1/8"	L165003703		200 x Pal	16,80 x Pal	327,80 x Pal



Natural 1L
Amazon Light



Description	Format	Codes	Group	Pcs	m2	Kg
AC4 Natural 1L Amazon Light	19,3x128,2x0,8cm 7 5/8"x50 1/2"x5/16"	100114150 L167011833	G-207	8 x Cj 416 x Pal	1,98 x Cj 102,75 x Pal	16,42 x Cj 853,63 x Pal
Skirting / Zócalo / Plinthe	8x220x1,5cm 3 1/8"x86 5/8"x5/8"	100155443 L165003229	G-107	14 x Cj 560 x Pal	2,46 x Cj 98,56 x Pal	19,32 x Cj 772,80 x Pal
Transition Profile / Perfil Transición / Profilé Jointoiment	4x270x1cm 1 3/4"x106 1/4"x3/8"	100164581 L165003487	G-155	20 x Cj 1000 x Pal	2,16 x Cj 108,00 x Pal	15,92 x Cj 796 x Pal
Levelling Profile / Perfil Igualación / Profilé Égalisation	4x270x1cm 1 3/4"x106 1/4"x3/8"	100164580 L165003458	G-155	20 x Cj 1000 x Pal	2,16 x Cj 108,00 x Pal	15,92 x Cj 796 x Pal
Stair Nosing / Mampelan / Nez de Marche	120x7x3cm 47 1/4"x2 3/4"x1 1/8"	100176696 L165003695	G-163	2 x Cj 200 x Pal	0,17 x Cj 16,80 x Pal	3,28 x Cj 327,80 x Pal



Natural 1L
Michigan Brown

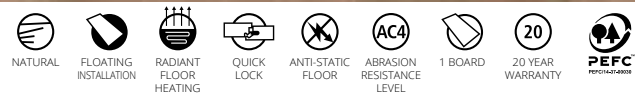

Description	Format	Codes	Group	Pcs	m2	Kg
AC4 Natural 1L Michigan Brown	19,3x128,2x0,8cm 7 5/8"x50 1/2"x5/16"	100156404 L165003278	G-207	8 x Cj 416 x Pal	1,97 x Cj 102,75 x Pal	15,86 x Cj 824,93 x Pal
Skirting / Zócalo / Plinthe	8x220x1,5cm 3 1/8"x86 5/8"x5/8"	100156443 L165003304	G-107	14 x Cj 560 x Pal	2,46 x Cj 98,56 x Pal	19,32 x Cj 772,80 x Pal
Transition Profile / Perfil Transición / Profilé Jointoiment	4x270x1cm 1 3/4"x106 1/4"x3/8"	100164833 L165003476	G-155	20 x Cj 1000 x Pal	2,16 x Cj 108,00 x Pal	15,92 x Cj 796 x Pal
Levelling Profile / Perfil Igualación / Profilé Égalisation	4x270x1cm 1 3/4"x106 1/4"x3/8"	100164588 L165003465	G-155	20 x Cj 1000 x Pal	2,16 x Cj 108,00 x Pal	15,92 x Cj 796 x Pal
Stair Nosing / Mampelan / Nez de Marche	120x7x3cm 47 1/4"x2 3/4"x1 1/8"	100176723 L165003700	G-163	2 x Cj 200 x Pal	0,17 x Cj 16,80 x Pal	3,28 x Cj 327,80 x Pal

Natural



Natural 1L Roble Life



Description	Format	Codes	Group	Pcs	m2	Kg
AC4 Natural 1L Roble Life	19,3x128,2x0,8cm 7 5/8"x50 1/2"x5/16"	100086955 L163122100	G-207	8 x Cj 416 x Pal	1,98 x Cj 102,75 x Pal	16,42 x Cj 853,63 x Pal
Skirting / Zócalo / Plinthe	8x220x1,5cm 3 1/8"x86 5/8"x5/8"	100158020 L165003374	G-107	14 x Cj 560 x Pal	2,46 x Cj 98,56 x Pal	19,32 x Cj 772,80 x Pal
Transition Profile / Perfil Transición / Profilé Jointolement	4x270x1cm 1 3/4"x106 1/4"x3/8"	100174655 L165003609	G-155	20 x Cj 1000 x Pal	2,16 x Cj 108,00 x Pal	15,92 x Cj 796 x Pal
Levelling Profile / Perfil Igualación / Profilé Égalisation	4x270x1cm 1 3/4"x106 1/4"x3/8"	100174654 L165003608	G-155	20 x Cj 1000 x Pal	2,16 x Cj 108,00 x Pal	15,92 x Cj 796 x Pal
Stair Nosing / Mampferlan / Nez de Marche	120x7x3cm 47 1/4"x2 3/4"x1 1/8"	100176753 L165003706	G-163	2 x Cj 200 x Pal	0,17 x Cj 16,80 x Pal	3,28 x Cj 327,80 x Pal



Natural 1L Michigan Clear



Description	Format	Codes	Group	Pcs	m2	Kg
AC4 Natural 1L Michigan Clear	19,3x128,2x0,8cm 7 5/8"x50 1/2"x5/16"	100156391 L165003274	G-207	8 x Cj 416 x Pal	1,97 x Cj 102,75 x Pal	15,86 x Cj 824,93 x Pal
Skirting / Zócalo / Plinthe	8x220x1,5cm 3 1/8"x86 5/8"x5/8"	100156444 L165003308	G-107	14 x Cj 560 x Pal	2,46 x Cj 98,56 x Pal	19,32 x Cj 772,80 x Pal
Transition Profile / Perfil Transición / Profilé Jointolement	4x270x1cm 1 3/4"x106 1/4"x3/8"	100173981 L165003606	G-155	20 x Cj 1000 x Pal	2,16 x Cj 108,00 x Pal	15,92 x Cj 796 x Pal
Levelling Profile / Perfil Igualación / Profilé Égalisation	4x270x1cm 1 3/4"x106 1/4"x3/8"	100173949 L165003729	G-155	20 x Cj 1000 x Pal	2,16 x Cj 108,00 x Pal	15,92 x Cj 796 x Pal
Stair Nosing / Mampferlan / Nez de Marche	120x7x3cm 47 1/4"x2 3/4"x1 1/8"	100176705 L165003689	G-163	2 x Cj 200 x Pal	0,17 x Cj 16,80 x Pal	3,28 x Cj 327,80 x Pal





Supreme

—
Ebano
Michigan Dark Brown
Africa
Amazon
Michigan Brown
Illinois
Valley
Michigan Clear
Michigan Grey
Texas
Boston
Castaño Sunset
Blanco Decape



LS 1L
Ebano



Description	Format	Codes	Group	Pcs	m2	Kg
AC4 LS 1L Ebano	24,3x220x0,8cm 9 5/8"x86 5/8"x3/8"	100086972 L159900314	G-224	5 x Cj 195 x Pal	2,67 x Cj 104,25 x Pal	20 x Cj 779,81 x Pal
Skirting / Zócalo / Plinthe	8x220x1,5cm 3 1/8"x86 5/8"x5/8"	100155407 L165003246	G-107	14 x Cj 560 x Pal	2,46 x Cj 98,56 x Pal	19,32 x Cj 772,80 x Pal
Transition Profile / Perfil Transición / Profilé Jointoiment	4x270x1cm 1 3/4"x106 1/4"x3/8"	100173614 L165003592	G-155	20 x Cj 1000 x Pal	2,16 x Cj 108,00 x Pal	15,92 x Cj 796 x Pal
Levelling Profile / Perfil Igualación / Profilé Égalisation	4x270x1cm 1 3/4"x106 1/4"x3/8"	100173606 L165003593	G-155	20 x Cj 1000 x Pal	2,16 x Cj 108,00 x Pal	15,92 x Cj 796 x Pal
Stair Nosing / Mampelan / Nez de Marche	120x7x3cm 47 1/4"x2 3/4"x1 1/8"	100176712 L165003686	G-163	2 x Cj 200 x Pal	0,17 x Cj 16,80 x Pal	3,28 x Cj 327,80 x Pal



LS 1L
Michigan Dark Brown



Description	Format	Codes	Group	Pcs	m2	Kg
AC4 LS 1L Michigan Dark Brown	24,3x220x0,8cm 9 5/8"x86 5/8"x3/8"	100156402 L165003296	G-224	5 x Cj 195 x Pal	2,67 x Cj 104,24 x Pal	19,99 x Cj 779,80 x Pal
Skirting / Zócalo / Plinthe	8x220x1,5cm 3 1/8"x86 5/8"x5/8"	100156409 L165003290	G-107	14 x Cj 560 x Pal	2,46 x Cj 98,56 x Pal	19,32 x Cj 772,80 x Pal
Transition Profile / Perfil Transición / Profilé Jointoiment	4x270x1cm 1 3/4"x106 1/4"x3/8"	100167320 L165003510	G-155	20 x Cj 1000 x Pal	2,16 x Cj 108,00 x Pal	15,92 x Cj 796 x Pal
Levelling Profile / Perfil Igualación / Profilé Égalisation	4x270x1cm 1 3/4"x106 1/4"x3/8"	100167314 L165003508	G-155	20 x Cj 1000 x Pal	2,16 x Cj 108,00 x Pal	15,92 x Cj 796 x Pal
Stair Nosing / Mampelan / Nez de Marche	120x7x3cm 47 1/4"x2 3/4"x1 1/8"	100176706 L165003690	G-163	2 x Cj 200 x Pal	0,17 x Cj 16,80 x Pal	3,28 x Cj 327,80 x Pal

Supreme



LS iL Africa



Description	Format	Codes	Group	Pcs	m2	Kg
AC4 LS 1L Africa	24.3x220x0.8cm 9 5/8"x86 5/8"x3/8"	100086966 L159900312	G-224	5 x Cj 195 x Pal	2,67 x Cj 104,25 x Pal	20 x Cj 779,81 x Pal
Skirting / Zócalo / Plinthe	8x220x1,5cm 3 1/8"x86 5/8"x5/8"	100155430 L165003243	G-107	14 x Cj 560 x Pal	2,46 x Cj 98,56 x Pal	19,32 x Cj 772,80 x Pal
Transition Profile / Perfil Transición / Profilé Jointolement	4x270x1cm 1 3/4"x106 1/4"x3/8"	100164832 L165003469	G-155	20 x Cj 1000 x Pal	2,16 x Cj 108,00 x Pal	15,92 x Cj 796 x Pal
Levelling Profile / Perfil Igualación / Profilé Égalisation	4x270x1cm 1 3/4"x106 1/4"x3/8"	100164835 L165003480	G-155	20 x Cj 1000 x Pal	2,16 x Cj 108,00 x Pal	15,92 x Cj 796 x Pal
Stair Nosing / Mampelran / Nez de Marche	120x7x3cm 47 1/4"x2 3/4"x1 1/8"	100176666 L165003682	G-163	2 x Cj 200 x Pal	0,17 x Cj 16,80 x Pal	3,28 x Cj 327,80 x Pal



LS iL Amazon



Description	Format	Codes	Group	Pcs	m2	Kg
AC4 LS 1L Amazon	24.3x220x0.8cm 9 5/8"x86 5/8"x3/8"	100113707 L167011762	G-224	5 x Cj 195 x Pal	2,67 x Cj 104,25 x Pal	20 x Cj 779,81 x Pal
Skirting / Zócalo / Plinthe	8x220x1,5cm 3 1/8"x86 5/8"x5/8"	100155440 L165003244	G-107	14 x Cj 560 x Pal	2,46 x Cj 98,56 x Pal	19,32 x Cj 772,80 x Pal
Transition Profile / Perfil Transición / Profilé Jointolement	4x270x1cm 1 3/4"x106 1/4"x3/8"	100160335 L165003405	G-155	20 x Cj 1000 x Pal	2,16 x Cj 108,00 x Pal	15,92 x Cj 796 x Pal
Levelling Profile / Perfil Igualación / Profilé Égalisation	4x270x1cm 1 3/4"x106 1/4"x3/8"	100160332 L165003404	G-155	20 x Cj 1000 x Pal	2,16 x Cj 108,00 x Pal	15,92 x Cj 796 x Pal
Stair Nosing / Mampelran / Nez de Marche	120x7x3cm 47 1/4"x2 3/4"x1 1/8"	100176702 L165003681	G-163	2 x Cj 200 x Pal	0,17 x Cj 16,80 x Pal	3,28 x Cj 327,80 x Pal



LS 1L
Michigan Brown



Description	Format	Codes	Group	Pcs	m2	Kg
AC4 LS 1L Michigan Brown	24,3x220x0,8cm 9 5/8"x86 5/8"x3/8"	100156400 L165003292	G-224	5 x Cj 195 x Pal	2,67 x Cj 104,24 x Pal	20 x Cj 779,80 x Pal
Skirting / Zócalo / Plinthe	8x220x1,5cm 3 1/8"x86 5/8"x5/8"	100156407 L165003287	G-107	14 x Cj 560 x Pal	2,46 x Cj 98,56 x Pal	19,32 x Cj 772,80 x Pal
Transition Profile / Perfil Transición / Profilé Jointoiment	4x270x1cm 1 3/4"x106 1/4"x3/8"	100177184 L165003726	G-155	20 x Cj 1000 x Pal	0,22 x Cj 10,8 x Pal	15,92 x Cj 796 x Pal
Levelling Profile / Perfil Igualación / Profilé Égalisation	4x270x1cm 1 3/4"x106 1/4"x3/8"	100177169 L165003724	G-155	20 x Cj 1000 x Pal	0,22 x Cj 10,8 x Pal	15,92 x Cj 796 x Pal
Stair Nosing / Mampelan / Nez de Marche	120x7x3cm 47 1/4"x2 3/4"x1 1/8"	100176693 L165003688	G-163	2 x Cj 200 x Pal	0,17 x Cj 16,80 x Pal	3,28 x Cj 327,80 x Pal



LS 1L
Illinois

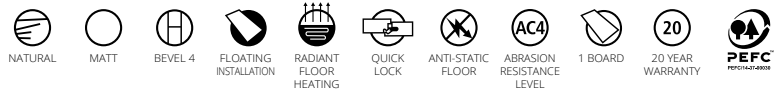

Description	Format	Codes	Group	Pcs	m2	Kg
AC4 LS 1L Illinois	24,3x220x0,8cm 9 5/8"x86 5/8"x3/8"	100086973 L159900315	G-224	5 x Cj 195 x Pal	2,67 x Cj 104,25 x Pal	20 x Cj 779,81 x Pal
Skirting / Zócalo / Plinthe	8x220x1,5cm 3 1/8"x86 5/8"x5/8"	100155408 L165003238	G-107	14 x Cj 560 x Pal	2,46 x Cj 98,56 x Pal	19,32 x Cj 772,80 x Pal
Transition Profile / Perfil Transición / Profilé Jointoiment	4x270x1cm 1 3/4"x106 1/4"x3/8"	100164823 L165003473	G-155	20 x Cj 1000 x Pal	2,16 x Cj 108,00 x Pal	15,92 x Cj 796 x Pal
Levelling Profile / Perfil Igualación / Profilé Égalisation	4x270x1cm 1 3/4"x106 1/4"x3/8"	100164587 L165003462	G-155	20 x Cj 1000 x Pal	2,16 x Cj 108,00 x Pal	15,92 x Cj 796 x Pal
Stair Nosing / Mampelan / Nez de Marche	120x7x3cm 47 1/4"x2 3/4"x1 1/8"	100176720 L165003687	G-163	2 x Cj 200 x Pal	0,17 x Cj 16,80 x Pal	3,28 x Cj 327,80 x Pal

STOCK

Supreme



LS 1L Valley

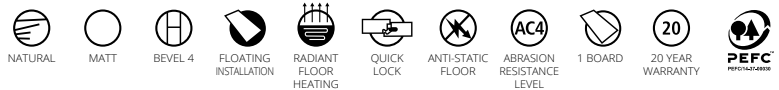

Description	Format	Codes	Group	Pcs	m2	Kg	
AC4 LS 1L Valley	24.3x220x0.8cm 9 5/8"x86 5/8"x3/8"	100086977 L159900309	G-224	5 x Cj 195 x Pal	2,67 x Cj 104,25 x Pal	20 x Cj 779,81 x Pal	STOCK
Skirting / Zócalo / Plinthe	8x220x1,5cm 3 1/8"x86 5/8"x5/8"	100155442 L165003259	G-107	14 x Cj 560 x Pal	2,46 x Cj 98,56 x Pal	19,32 x Cj 772,80 x Pal	
Transition Profile / Perfil Transición / Profilé Jointolement	4x270x1cm 1 3/4"x106 1/4"x3/8"	100164574 L165003491	G-155	20 x Cj 1000 x Pal	2,16 x Cj 108,00 x Pal	15,92 x Cj 796 x Pal	
Levelling Profile / Perfil Igualación / Profilé Égalisation	4x270x1cm 1 3/4"x106 1/4"x3/8"	100164605 L165003461	G-155	20 x Cj 1000 x Pal	2,16 x Cj 108,00 x Pal	15,92 x Cj 796 x Pal	
Stair Nosing / Mampelran / Nez de Marche	120x7x3cm 47 1/4"x2 3/4"x1 1/8"	100176695 L165003694	G-163	2 x Cj 200 x Pal	0,17 x Cj 16,80 x Pal	3,28 x Cj 327,80 x Pal	



LS 1L Michigan Clear



Description	Format	Codes	Group	Pcs	m2	Kg	
AC4 LS 1L Michigan Clear	24.3x220x0.8cm 9 5/8"x86 5/8"x3/8"	100156401 L165003276	G-224	5 x Cj 195 x Pal	2,67 x Cj 104,24 x Pal	20 x Cj 779,80 x Pal	STOCK
Skirting / Zócalo / Plinthe	8x220x1,5cm 3 1/8"x86 5/8"x5/8"	100156408 L165003293	G-107	14 x Cj 560 x Pal	2,46 x Cj 98,56 x Pal	19,32 x Cj 772,80 x Pal	
Transition Profile / Perfil Transición / Profilé Jointolement	4x270x1cm 1 3/4"x106 1/4"x3/8"	100164559 L165003490	G-155	20 x Cj 1000 x Pal	2,16 x Cj 108,00 x Pal	15,92 x Cj 796 x Pal	
Levelling Profile / Perfil Igualación / Profilé Égalisation	4x270x1cm 1 3/4"x106 1/4"x3/8"	100164604 L165003460	G-155	20 x Cj 1000 x Pal	2,16 x Cj 108,00 x Pal	15,92 x Cj 796 x Pal	
Stair Nosing / Mampelran / Nez de Marche	120x7x3cm 47 1/4"x2 3/4"x1 1/8"	100176762 L165003704	G-159	2 x Cj 200 x Pal	0,17 x Cj 16,80 x Pal	3,28 x Cj 327,80 x Pal	



LS 1L
Michigan Grey



Description	Format	Codes	Group	Pcs	m2	Kg
AC4 LS 1L Michigan Grey	24,3x220x0,8cm 9 5/8"x86 5/8"x3/8"	100156403 L165003280	G-224	5 x CJ 195 x Pal	2,67 x CJ 104,24 x Pal	20 x CJ 779,80 x Pal
Skirting / Zócalo / Plinthe	8x220x1,5cm 3 1/8"x86 5/8"x5/8"	100156440 L165003297	G-107	14 x CJ 560 x Pal	2,46 x CJ 98,56 x Pal	19,32 x CJ 772,80 x Pal
Transition Profile / Perfil Transición / Profilé Jointoiment	4x270x1cm 1 3/4"x106 1/4"x3/8"	100165090 L165003494	G-155	20 x CJ 1000 x Pal	0,22 x CJ 10,8 x Pal	15,92 x CJ 796 x Pal
Levelling Profile / Perfil Igualación / Profilé Égalisation	4x270x1cm 1 3/4"x106 1/4"x3/8"	100165059 L165003550	G-155	20 x CJ 1000 x Pal	0,22 x CJ 10,8 x Pal	15,92 x CJ 796 x Pal
Stair Nosing / Mampierlan / Nez de Marche	120x7x3cm 47 1/4"x2 3/4"x1 1/8"	100176707 L165003691	G-163	2 x CJ 200 x Pal	0,17 x CJ 16,80 x Pal	3,28 x CJ 327,80 x Pal



LS 1L
Texas



Description	Format	Codes	Group	Pcs	m2	Kg
AC4 LS 1L Texas	24,3x220x0,8cm 9 5/8"x86 5/8"x3/8"	100086975 L159900316	G-224	5 x CJ 195 x Pal	2,67 x CJ 104,25 x Pal	20 x CJ 779,81 x Pal
Skirting / Zócalo / Plinthe	8x220x1,5cm 3 1/8"x86 5/8"x5/8"	100155441 L165003231	G-107	14 x CJ 560 x Pal	2,46 x CJ 98,56 x Pal	19,32 x CJ 772,80 x Pal
Transition Profile / Perfil Transición / Profilé Jointoiment	4x270x1cm 1 3/4"x106 1/4"x3/8"	100160760 L165003400	G-155	20 x CJ 1000 x Pal	2,16 x CJ 108,00 x Pal	15,92 x CJ 796 x Pal
Levelling Profile / Perfil Igualación / Profilé Égalisation	4x270x1cm 1 3/4"x106 1/4"x3/8"	100160669 L165003453	G-155	20 x CJ 1000 x Pal	2,16 x CJ 108,00 x Pal	15,92 x CJ 796 x Pal
Stair Nosing / Mampierlan / Nez de Marche	120x7x3cm 47 1/4"x2 3/4"x1 1/8"	100176694 L165003693	G-163	2 x CJ 200 x Pal	0,17 x CJ 16,80 x Pal	3,28 x CJ 327,80 x Pal

Supreme



LS 1L Boston

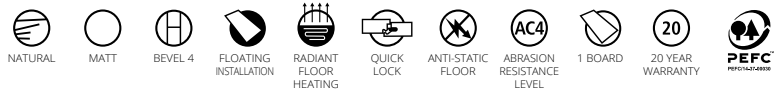

Description	Format	Codes	Group	Pcs	m2	Kg
AC4 LS 1L Boston	24.3x220x0.8cm	100086971	G-224	5 x Cj	2,67 x Cj	20 x Cj
	9 5/8"x86 5/8"x3/8"	L159900308		195 x Pal	104,25 x Pal	779,81 x Pal
Skirting / Zócalo / Plinthe	8x220x1.5cm	100155404	G-107	14 x Cj	2,46 x Cj	19,32 x Cj
	3 1/8"x86 5/8"x5/8"	L165003251		560 x Pal	98,56 x Pal	772,80 x Pal
Transition Profile / Perfil Transición / Profilé Jointoiment	4x270x1cm	100160336	G-155	20 x Cj	2,16 x Cj	15,92 x Cj
	1 3/4"x106 1/4"x3/8"	L165003502		1000 x Pal	108,00 x Pal	796 x Pal
Levelling Profile / Perfil Igualación / Profilé Egalisation	4x270x1cm	100160333	G-155	20 x Cj	2,16 x Cj	15,92 x Cj
	1 3/4"x106 1/4"x3/8"	L165003503		1000 x Pal	108,00 x Pal	796 x Pal
Stair Nosing / Mampelran / Nez de Marche	120x7x3cm	100176668	G-163	2 x Cj	0,17 x Cj	3,28 x Cj
	47 1/4"x2 3/4"x1 1/8"	L165003679		200 x Pal	16,80 x Pal	327,80 x Pal



Floor Coverings AC4 LS 1L Boston



LS 1L
Blanco Decape



Description	Format	Codes	Group	Pcs	m2	Kg
AC4 LS 1L Blanco Decape	24,3x220x0,8cm 9 5/8"x86 5/8"x3/8"	100086970 L159900305	G-224	5 x Cj 195 x Pal	2,67 x Cj 104,25 x Pal	20 x Cj 779,81 x Pal
Skirting / Zócalo / Plinthe	8x220x1,5cm 3 1/8"x86 5/8"x5/8"	100155403 L165003230	G-107	14 x Cj 560 x Pal	2,46 x Cj 98,56 x Pal	19,32 x Cj 772,80 x Pal
Transition Profile / Perfil Transición / Profilé Jointoiment	4x270x1cm 1 3/4"x106 1/4"x3/8"	100167252 L165003507	G-155	20 x Cj 1000 x Pal	0,22 x Cj 10,8 x Pal	15,92 x Cj 796 x Pal
Levelling Profile / Perfil Igualación / Profilé Égalisation	4x270x1cm 1 3/4"x106 1/4"x3/8"	100167242 L165003506	G-155	20 x Cj 1000 x Pal	0,22 x Cj 10,8 x Pal	15,92 x Cj 796 x Pal
Stair Nosing / Mampelran / Nez de Marche	120x7x3cm 47 1/4"x2 3/4"x1 1/8"	100176667 L165003680	G-163	2 x Cj 200 x Pal	0,17 x Cj 16,80 x Pal	3,28 x Cj 327,80 x Pal

STOCK

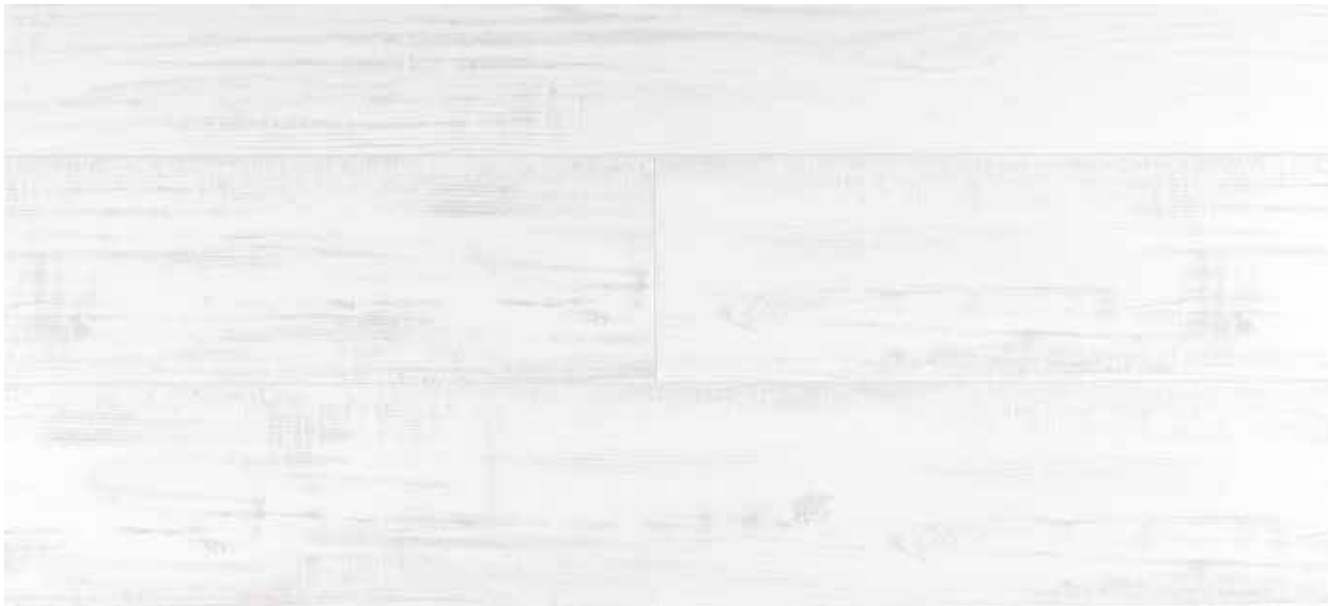

LS 1L
Castaño Sunset

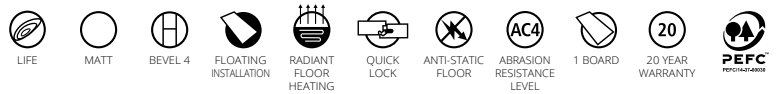

Description	Format	Codes	Group	Pcs	m2	Kg
AC4 LS 1L Castaño Sunset	24,3x220x0,8cm 9 5/8"x86 5/8"x3/8"	100113708 L167011760	G-224	5 x Cj 195 x Pal	2,67 x Cj 104,25 x Pal	20 x Cj 779,81 x Pal
Skirting / Zócalo / PlintheVv	8x220x1,5cm 3 1/8"x86 5/8"x5/8"	100155405 L165003233	G-107	14 x Cj 560 x Pal	2,46 x Cj 98,56 x Pal	19,32 x Cj 772,80 x Pal
Transition Profile / Perfil Transición / Profilé Jointoiment	4x270x1cm 1 3/4"x106 1/4"x3/8"	100164822 L165003471	G-155	20 x Cj 1000 x Pal	2,16 x Cj 108,00 x Pal	15,92 x Cj 796 x Pal
Levelling Profile / Perfil Igualación / Profilé Égalisation	4x270x1cm 1 3/4"x106 1/4"x3/8"	100164841 L165003482	G-155	20 x Cj 1000 x Pal	2,16 x Cj 108,00 x Pal	15,92 x Cj 796 x Pal
Stair Nosing / Mampelran / Nez de Marche	120x7x3cm 47 1/4"x2 3/4"x1 1/8"	100176711 L165003677	G-163	2 x Cj 200 x Pal	0,17 x Cj 16,80 x Pal	3,28 x Cj 327,80 x Pal







Residence

—
New Jersey
Iowa
Roble
Roble Decape
Vermont
Virginia
Ohio
Nogal
Idaho
Misuri
Nevada
Utah
Arizona



Residence 1L
New Jersey



Description	Format	Codes	Group	Pcs	m2	Kg
AC4 Residence 1L New Jersey	19,3x138x0,8cm 7 5/8"x54 3/8"x5/16"	100176290 L167012700	G-200	8 x Cj 448 x Pal	2,13 x Cj 119,32 x Pal	13,78 x Cj 771,90 x Pal
Skirting / Zócalo / Plinthe	8x220x1,5cm 3 1/8"x86 5/8"x5/8"	100181340 L167012807	G-107	14 x Cj 560 x Pal	2,46 x Cj 98,56 x Pal	19,32 x Cj 772,80 x Pal
Levelling Profile / Perfil Igualación / Profilé Égalisation	4x270x1cm 1 3/4"x106 1/4"x3/8"	100115884 L167011921	G-155	20 x Cj 1000 x Pal	2,15 x Cj 107,36 x Pal	14,06 x Cj 703 x Pal
Transition Profile / Perfil Transición / Profilé Jointoiment	4x270x1cm 1 3/4"x106 1/4"x3/8"	100115895 L167011920	G-155	20 x Cj 1000 x Pal	2,05 x Cj 102,48 x Pal	14,38 x Cj 719 x Pal
Stair Nosing / Mampelan / Nez de Marche	120x7x3cm 47 1/4"x2 3/4"x1 1/8"	100176725 L167012674	G-163	2 x Cj 200 x Pal	0,17 x Cj 16,80 x Pal	3,28 x Cj 327,80 x Pal



Residence 2L
Iowa

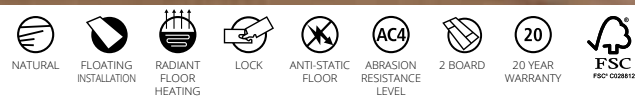

Description	Format	Codes	Group	Pcs	m2	Kg
AC4 Residence 2L Iowa	19,3x138x0,8cm 7 5/8"x54 3/8"x5/16"	100176300 L167012706	G-200	8 x Cj 448 x Pal	2,13 x Cj 119,32 x Pal	13,78 x Cj 771,90 x Pal
Skirting / Zócalo / Plinthe	8x220x1,5cm 3 1/8"x86 5/8"x5/8"	100181313 L167012806	G-107	14 x Cj 560 x Pal	2,46 x Cj 98,56 x Pal	19,32 x Cj 772,80 x Pal
Levelling Profile / Perfil Igualación / Profilé Égalisation	4x270x1cm 1 3/4"x106 1/4"x3/8"	100115882 L167011922	G-155	20 x Cj 1000 x Pal	2,15 x Cj 107,36 x Pal	14,06 x Cj 703 x Pal
Transition Profile / Perfil Transición / Profilé Jointoiment	4x270x1cm 1 3/4"x106 1/4"x3/8"	100115893 L167011928	G-155	20 x Cj 1000 x Pal	2,05 x Cj 102,48 x Pal	14,38 x Cj 719 x Pal
Stair Nosing / Mampelan / Nez de Marche	120x7x3cm 47 1/4"x2 3/4"x1 1/8"	100176755 L167012695	G-163	2 x Cj 200 x Pal	0,17 x Cj 16,80 x Pal	3,28 x Cj 327,80 x Pal

Residence



Residence 1L Roble



Description	Format	Codes	Group	Pcs	m2	Kg
AC4 Residence 1L Roble	19,3x138x0,8cm	100176291	G-200	8 x Cj	2,13 x Cj	13,78 x Cj
	7 5/8"x54 3/8"x5/16"	L167012705		448 x Pal	119,32 x Pal	771,90 x Pal
Skirting / Zócalo / Plinthe	8x220x1,5cm	100181312	G-107	14 x Cj	2,46 x Cj	19,32 x Cj
	3 1/8"x86 5/8"x5/8"	L167012804		560 x Pal	98,56 x Pal	772,80 x Pal
Transition Profile / Perfil Transición / Profilé Jointolement	4x270x1cm	100160662	G-155	20 x Cj	2,16 x Cj	15,92 x Cj
	1 3/4"x106 1/4"x3/8"	L167012566		1000 x Pal	108,00 x Pal	796 x Pal
Levelling Profile / Perfil Igualación / Profilé Égalisation	4x270x1cm	100160661	G-155	20 x Cj	2,16 x Cj	15,92 x Cj
	1 3/4"x106 1/4"x3/8"	L167012567		1000 x Pal	108,00 x Pal	796 x Pal
Stair Nosing / Mampelan / Nez de Marche	120x7x3cm	100176715	G-163	2 x Cj	0,17 x Cj	3,28 x Cj
	47 1/4"x2 3/4"x1 1/8"	L167012673		200 x Pal	16,80 x Pal	327,80 x Pal



Residence 1L Roble Decape



Description	Format	Codes	Group	Pcs	m2	Kg
AC4 Residence 1L Roble Decape	19,3x138x0,8cm	100176288	G-200	8 x Cj	2,13 x Cj	13,78 x Cj
	7 5/8"x54 3/8"x5/16"	L167012701		448 x Pal	119,32 x Pal	771,90 x Pal
Skirting / Zócalo / Plinthe	8x220x1,5cm	100181314	G-107	14 x Cj	2,46 x Cj	19,32 x Cj
	3 1/8"x86 5/8"x5/8"	L167012809		560 x Pal	98,56 x Pal	772,80 x Pal
Transition Profile / Perfil Transición / Profilé Jointolement	4x270x1cm	100164952	G-155	20 x Cj	2,16 x Cj	15,92 x Cj
	1 3/4"x106 1/4"x3/8"	L167012592		1000 x Pal	108,00 x Pal	796 x Pal
Levelling Profile / Perfil Igualación / Profilé Égalisation	4x270x1cm	100164933	G-155	20 x Cj	2,16 x Cj	15,92 x Cj
	1 3/4"x106 1/4"x3/8"	L167012600		1000 x Pal	108,00 x Pal	796 x Pal
Stair Nosing / Mampelan / Nez de Marche	120x7x3cm	100176726	G-163	2 x Cj	0,17 x Cj	3,28 x Cj
	47 1/4"x2 3/4"x1 1/8"	L167012672		200 x Pal	16,80 x Pal	327,80 x Pal



Residence 1L Vermont



Description	Format	Codes	Group	Pcs	m2	Kg
AC4 Residence 1L Vermont	19,3x138x0,8cm	100176289	G-200	8 x Cj	2,13 x Cj	13,78 x Cj
	7 5/8"x54 3/8"x5/16"	L167012702		448 x Pal	119,32 x Pal	771,90 x Pal
Skirting / Zócalo / Plinthe	8x220x1,5cm	100181315	G-107	14 x Cj	2,46 x Cj	19,32 x Cj
	3 1/8"x86 5/8"x5/8"	L167012805		560 x Pal	98,56 x Pal	772,80 x Pal
Levelling Profile / Perfil Igualación / Profilé Égalisation	4x270x1cm	100115886	G-155	20 x Cj	2,15 x Cj	14,06 x Cj
	1 3/4"x106 1/4"x3/8"	L167011911		1000 x Pal	107,36 x Pal	703 x Pal
Transition Profile / Perfil Transición / Profilé Jointoiment	4x270x1cm	100115897	G-155	20 x Cj	2,05 x Cj	14,38 x Cj
	1 3/4"x106 1/4"x3/8"	L167011908		1000 x Pal	102,48 x Pal	719 x Pal
Stair Nosing / Mampelan / Nez de Marche	120x7x3cm	100176754	G-163	2 x Cj	0,17 x Cj	3,28 x Cj
	47 1/4"x2 3/4"x1 1/8"	L167012675		200 x Pal	16,80 x Pal	327,80 x Pal



Residence 1L Virginia



Description	Format	Codes	Group	Pcs	m2	Kg
AC4 Residence 1L Virginia	19,3x138x0,8cm	100175398	G-200	8 x Cj	2,13 x Cj	13,78 x Cj
	7 5/8"x54 3/8"x5/16"	L167012704		448 x Pal	119,32 x Pal	771,90 x Pal
Skirting / Zócalo / Plinthe	8x220x1,5cm	100181316	G-107	14 x Cj	2,46 x Cj	19,32 x Cj
	3 1/8"x86 5/8"x5/8"	L167012803		560 x Pal	98,56 x Pal	772,80 x Pal
Levelling Profile / Perfil Igualación / Profilé Égalisation	4x270x1cm	100115887	G-155	20 x Cj	2,15 x Cj	14,06 x Cj
	1 3/4"x106 1/4"x3/8"	L167011915		1000 x Pal	107,36 x Pal	703 x Pal
Transition Profile / Perfil Transición / Profilé Jointoiment	4x270x1cm	100115898	G-155	20 x Cj	2,05 x Cj	14,38 x Cj
	1 3/4"x106 1/4"x3/8"	L167011914		1000 x Pal	102,48 x Pal	719 x Pal
Stair Nosing / Mampelan / Nez de Marche	120x7x3cm	100176744	G-163	2 x Cj	0,17 x Cj	3,28 x Cj
	47 1/4"x2 3/4"x1 1/8"	L167012676		200 x Pal	16,80 x Pal	327,80 x Pal

Residence



Residence 3L Ohio



Description	Format	Codes	Group	Pcs	m2	Kg
AC4 Residence 3L Ohio	19,3x138x0,8cm	100175399	G-200	8 x Cj	2,13 x Cj	13,78 x Cj
	7 5/8"x54 3/8"x5/16"	L167012707		448 x Pal	119,32 x Pal	771,90 x Pal
Skirting / Zócalo / Plinthe	8x220x1,5cm	100181331	G-107	14 x Cj	2,46 x Cj	19,32 x Cj
	3 1/8"x86 5/8"x5/8"	L167012808		560 x Pal	98,56 x Pal	772,80 x Pal
Levelling Profile / Perfil Igualación / Profilé Egalisation	4x270x1cm	100115885	G-155	20 x Cj	2,15 x Cj	14,06 x Cj
	1 3/4"x106 1/4"x3/8"	L167011907		1000 x Pal	107,36 x Pal	703 x Pal
Transition Profile / Perfil Transición / Profilé Jointolement	4x270x1cm	100115896	G-155	20 x Cj	2,05 x Cj	14,38 x Cj
	1 3/4"x106 1/4"x3/8"	L167011925		1000 x Pal	102,48 x Pal	719 x Pal
Stair Nosing / Mamporan / Nez de Marche	120x7x3cm	100176763	G-163	2 x Cj	0,17 x Cj	3,28 x Cj
	47 1/4"x2 3/4"x1 1/8"	L167012677		200 x Pal	16,80 x Pal	327,80 x Pal



Laminate Flooring

Floor Coverings AC4 Residence 3L Ohio



Residence 1L
Nogal

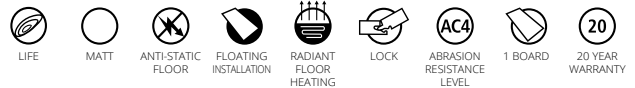

Description	Format	Codes	Group	Pcs	m2	Kg
AC4 Residence 1L Nogal	19,3x138x0,8cm 7 5/8"x54 3/8"x5/16"	100202966 L167012908	G-200	8 x Cj 448 x Pal	2,13 x Cj 119,32 x Pal	14,80 x Cj 828,80 x Pal
Skirting / Zócalo / Plinthe	8x220x1,5cm 3 1/8"x86 5/8"x5/8"	100202973 L167012907	G-107	14 x Cj 560 x Pal	2,46 x Cj 98,56 x Pal	19,32 x Cj 772,80 x Pal
Levelling Profile / Perfil Igualación / Profilé Égalisation	4x270x1cm 1 3/4"x106 1/4"x3/8"	100202970 L167012904	G-155	20 x Cj 1000 x Pal	2,16 x Cj 108 x Pal	14,06 x Cj 703 x Pal
Transition Profile / Perfil Transición / Profilé Jointoiment	4x270x1cm 1 3/4"x106 1/4"x3/8"	100202972 L167012905	G-155	20 x Cj 1000 x Pal	2,16 x Cj 108 x Pal	14,38 x Cj 719 x Pal
Stair Nosing / Mampelan / Nez de Marche	120x7x3cm 47 1/4"x2 3/4"x1 1/8"	100202971 L167012906	G-163	2 x Cj 200 x Pal	0,16 x Cj 16,80 x Pal	3,27 x Cj 327,80 x Pal

NEW



Residence 1L
Idaho

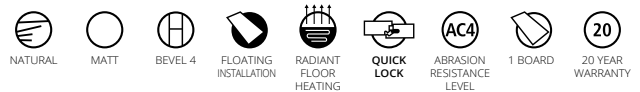

Description	Format	Codes	Group	Pcs	m2	Kg
AC4 Residence 1L Idaho	19,3x138x0,8cm 7 5/8"x54 3/8"x5/16"	100201389 L167012880	G-200	8 x Cj 448 x Pal	2,13 x Cj 119,32 x Pal	14,80 x Cj 828,80 x Pal
Skirting / Zócalo / Plinthe	8x220x1,5cm 3 1/8"x86 5/8"x5/8"	100202662 L167012900	G-107	14 x Cj 560 x Pal	2,46 x Cj 98,56 x Pal	19,32 x Cj 772,80 x Pal
Levelling Profile / Perfil Igualación / Profilé Égalisation	4x270x1cm 1 3/4"x106 1/4"x3/8"	100202651 L167012885	G-155	20 x Cj 1000 x Pal	2,16 x Cj 108 x Pal	14,06 x Cj 703 x Pal
Transition Profile / Perfil Transición / Profilé Jointoiment	4x270x1cm 1 3/4"x106 1/4"x3/8"	100202655 L167012895	G-155	20 x Cj 1000 x Pal	2,16 x Cj 108 x Pal	14,38 x Cj 719 x Pal
Stair Nosing / Mampelan / Nez de Marche	120x7x3cm 47 1/4"x2 3/4"x1 1/8"	100202638 L167012890	G-163	2 x Cj 200 x Pal	0,16 x Cj 16,80 x Pal	3,27 x Cj 327,80 x Pal

NEW

Residence



Residence 1L Misuri



Description	Format	Codes	Group	Pcs	m2	Kg
AC4 Residence 1L Misuri	19,3x138x0,8cm 7 5/8"x54 3/8"x5/16"	100201397 L167012882	G-200	8 x Cj 448 x Pal	2,13 x Cj 119,32 x Pal	14,80 x Cj 828,80 x Pal
Skirting / Zócalo / Plinthe	8x220x1,5cm 3 1/8"x86 5/8"x5/8"	100202656 L167012901	G-107	14 x Cj 560 x Pal	2,46 x Cj 98,56 x Pal	19,32 x Cj 772,80 x Pal
Levelling Profile / Perfil Igualación / Profilé Égalisation	4x270x1cm 1 3/4"x106 1/4"x3/8"	100202645 L167012886	G-155	20 x Cj 1000 x Pal	2,16 x Cj 108 x Pal	14,06 x Cj 703 x Pal
Transition Profile / Perfil Transición / Profilé Jointoierment	4x270x1cm 1 3/4"x106 1/4"x3/8"	100202660 L167012896	G-155	20 x Cj 1000 x Pal	2,16 x Cj 108 x Pal	14,38 x Cj 719 x Pal
Stair Nosing / Mampelran / Nez de Marche	120x7x3cm 47 1/4"x2 3/4"x1 1/8"	100202653 L167012891	G-163	2 x Cj 200 x Pal	0,16 x Cj 16,80 x Pal	3,27 x Cj 327,80 x Pal

NEW



Residence 1L Nevada



Description	Format	Codes	Group	Pcs	m2	Kg
AC4 Residence 1L Nevada	19,3x138x0,8cm 7 5/8"x54 3/8"x5/16"	100201404 L167012881	G-200	8 x Cj 448 x Pal	2,13 x Cj 119,32 x Pal	14,80 x Cj 828,80 x Pal
Skirting / Zócalo / Plinthe	8x220x1,5cm 3 1/8"x86 5/8"x5/8"	100202657 L167012902	G-107	14 x Cj 560 x Pal	2,46 x Cj 98,56 x Pal	19,32 x Cj 772,80 x Pal
Levelling Profile / Perfil Igualación / Profilé Égalisation	4x270x1cm 1 3/4"x106 1/4"x3/8"	100202637 L167012887	G-155	20 x Cj 1000 x Pal	2,16 x Cj 108 x Pal	14,06 x Cj 703 x Pal
Transition Profile / Perfil Transición / Profilé Jointoierment	4x270x1cm 1 3/4"x106 1/4"x3/8"	100202627 L167012897	G-155	20 x Cj 1000 x Pal	2,16 x Cj 108 x Pal	14,38 x Cj 719 x Pal
Stair Nosing / Mampelran / Nez de Marche	120x7x3cm 47 1/4"x2 3/4"x1 1/8"	100202647 L167012892	G-163	2 x Cj 200 x Pal	0,16 x Cj 16,80 x Pal	3,27 x Cj 327,80 x Pal

NEW



Residence 1L
Utah

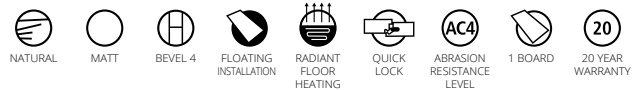

Description	Format	Codes	Group	Pcs	m2	Kg
AC4 Residence 1L Utah	19,3x138x0,8cm 7 5/8"x54 3/8"x5/16"	100201410 L167012883	G-200	8 x Cj 448 x Pal	2,13 x Cj 119,32 x Pal	14,80 x Cj 828,80 x Pal
Skirting / Zócalo / Plinthe	8x220x1,5cm 3 1/8"x86 5/8"x5/8"	100202649 L167012903	G-107	14 x Cj 560 x Pal	2,46 x Cj 98,56 x Pal	19,32 x Cj 772,80 x Pal
Levelling Profile / Perfil Igualación / Profilé Égalisation	4x270x1cm 1 3/4"x106 1/4"x3/8"	100202652 L167012888	G-155	20 x Cj 1000 x Pal	2,16 x Cj 108 x Pal	14,06 x Cj 703 x Pal
Transition Profile / Perfil Transición / Profilé Jointoiment	4x270x1cm 1 3/4"x106 1/4"x3/8"	100202661 L167012898	G-155	20 x Cj 1000 x Pal	2,16 x Cj 108 x Pal	14,38 x Cj 719 x Pal
Stair Nosing / Mampelan / Nez de Marche	120x7x3cm 47 1/4"x2 3/4"x1 1/8"	100202654 L167012893	G-163	2 x Cj 200 x Pal	0,16 x Cj 16,80 x Pal	3,27 x Cj 327,80 x Pal

NEW



Residence 1L
Arizona



Description	Format	Codes	Group	Pcs	m2	Kg
AC4 Residence 1L Arizona	19,3x138x0,8cm 7 5/8"x54 3/8"x5/16"	100201388 L167012879	G-200	8 x Cj 448 x Pal	2,13 x Cj 119,32 x Pal	14,80 x Cj 828,80 x Pal
Skirting / Zócalo / Plinthe	8x220x1,5cm 3 1/8"x86 5/8"x5/8"	100202648 L167012899	G-107	14 x Cj 560 x Pal	2,46 x Cj 98,56 x Pal	19,32 x Cj 772,80 x Pal
Levelling Profile / Perfil Igualación / Profilé Égalisation	4x270x1cm 1 3/4"x106 1/4"x3/8"	100202626 L167012884	G-155	20 x Cj 1000 x Pal	2,16 x Cj 108 x Pal	14,06 x Cj 703 x Pal
Transition Profile / Perfil Transición / Profilé Jointoiment	4x270x1cm 1 3/4"x106 1/4"x3/8"	100202639 L167012894	G-155	20 x Cj 1000 x Pal	2,16 x Cj 108 x Pal	14,38 x Cj 719 x Pal
Stair Nosing / Mampelan / Nez de Marche	120x7x3cm 47 1/4"x2 3/4"x1 1/8"	100202646 L167012889	G-163	2 x Cj 200 x Pal	0,16 x Cj 16,80 x Pal	3,27 x Cj 327,80 x Pal

NEW



Style

—
Smooth
Mild
Quiet
Calm
Soft





Style 1L
Smooth



Description	Format	Codes	Group	Pcs	m2	Kg
AC4 Style 1L Smooth	19,05x126,1x0,7cm 7 1/2"x49 5/8"x1/4"	100199499 L167012871	G-204	10 x Cj 480 x Pal	2,40 x Cj 115,30 x Pal	16,48 x Cj 791,04 x Pal
Skirting / Zócalo / Plinthe	8x220x1,4cm 3 1/8"x86 5/8"x9/16"	100174148 L167012662	G-107	12 x Cj 600 x Pal	2,11 x Cj 105,60 x Pal	31,22 x Cj 1561,20 x Pal
Levelling Profile / Perfil Igualación / Profilé Égalisation	4x270x1cm 1 3/4"x106 1/4"x3/8"	100115892 L167011916	G-155	20 x Cj 1000 x Pal	2,16 x Cj 108 x Pal	15,38 x Cj 769 x Pal
Transition Profile / Perfil Transición / Profilé Jointoiment	4x270x1cm 1 3/4"x106 1/4"x3/8"	100115903 L167011909	G-155	20 x Cj 1000 x Pal	0,22 x Cj 10,80 x Pal	15,92 x Cj 796 x Pal
Stair Nosing / Mampelan / Nez de Marche	120x7x3cm 47 1/4"x2 3/4"x1 1/8"	100176738 L167012679	G-163	2 x Cj 200 x Pal	0,17 x Cj 16,80 x Pal	3,28 x Cj 327,80 x Pal

STOCK



Style 1L
Mild



Description	Format	Codes	Group	Pcs	m2	Kg
AC4 Style 1L Mild	19,05x126,1x0,7cm 7 1/2"x49 5/8"x1/4"	100199461 L167012868	G-204	10 x Cj 480 x Pal	2,40 x Cj 115,30 x Pal	16,48 x Cj 791,04 x Pal
Skirting / Zócalo / Plinthe	8x220x1,4cm 3 1/8"x88 5/8"x1/2"	100174137 L167012659	G-107	12 x Cj 600 x Pal	2,16 x Cj 105,60 x Pal	31,22 x Cj 1561,20 X Pal
Levelling Profile / Perfil Igualación / Profilé Égalisation	4x270x1cm 1 3/4"x106 1/4"x3/8"	100115890 L167011927	G-155	20 x Cj 1000 x Pal	2,16 x Cj 108 x Pal	15,38 x Cj 769 x Pal
Transition Profile / Perfil Transición / Profilé Jointoiment	4x270x1cm 1 3/4"x106 1/4"x3/8"	100115901 L167011912	G-155	20 x Cj 1000 x Pal	0,22 x Cj 10,80 x Pal	15,92 x Cj 796 x Pal
Stair Nosing / Mampelan / Nez de Marche	120x7x3cm 47 1/4"x2 3/4"x1 1/8"	100176764 L167012682	G-163	2 x Cj 200 x Pal	0,17 x Cj 16,80 x Pal	3,28 x Cj 327,80 x Pal

Style



Style iL Quiet



Description	Format	Codes	Group	Pcs	m2	Kg	
AC4 Style 1L Quiet	19,05x126,1x0,7cm 7 1/2"x49 5/8"x1/4"	100199476 L167012870	G-204	10 x Cj 480 x Pal	2,40 x Cj 115,30 x Pal	16,48 x Cj 791,04 x Pal	STOCK
Skirting / Zócalo / Plinthe	8x220x1,4cm 3 1/8"x86 5/8"x9/16"	100174138 L167012664	G-107	12 x Cj 600 x Pal	2,11 x Cj 105,60 x Pal	31,22 x Cj 1561,20 x Pal	
Levelling Profile / Perfil Igualación / Profilé Égalisation	4x270x1cm 1 3/4"x106 1/4"x3/8"	100115891 L167011918	G-155	20 x Cj 1000 x Pal	2,16 x Cj 108 x Pal	15,38 x Cj 769 x Pal	
Transition Profile / Perfil Transición / Profilé Jointoierment	4x270x1cm 1 3/4"x106 1/4"x3/8"	100115902 L167011926	G-155	20 x Cj 1000 x Pal	0,22 x Cj 10,80 x Pal	15,92 x Cj 796 x Pal	
Stair Nosing / Mampelran / Nez de Marche	120x7x3cm 47 1/4"x2 3/4"x1 1/8"	100176737 L167012683	G-163	2 x Cj 200 x Pal	0,17 x Cj 16,80 x Pal	3,28 x Cj 327,80 x Pal	



Style iL Calm



Description	Format	Codes	Group	Pcs	m2	Kg	
AC4 Style 1L Calm	19,05x126,1x0,7cm 7 1/2"x49 5/8"x1/4"	100199495 L167012869	G-204	10 x Cj 480 x Pal	2,40 x Cj 115,30 x Pal	16,48 x Cj 791,04 x Pal	STOCK
Skirting / Zócalo / Plinthe	8x220x1,4cm 3 1/8"x86 5/8"x9/16"	100174157 L167012663	G-107	12 x Cj 600 x Pal	2,11 x Cj 105,60 x Pal	31,22 x Cj 1561,20 x Pal	
Levelling Profile / Perfil Igualación / Profilé Égalisation	4x270x1cm 1 3/4"x106 1/4"x3/8"	100115889 L167011910	G-155	20 x Cj 1000 x Pal	2,16 x Cj 108 x Pal	15,38 x Cj 769 x Pal	
Transition Profile / Perfil Transición / Profilé Jointoierment	4x270x1cm 1 3/4"x106 1/4"x3/8"	100115900 L167011919	G-155	20 x Cj 1000 x Pal	0,22 x Cj 10,80 x Pal	15,92 x Cj 796 x Pal	
Stair Nosing / Mampelran / Nez de Marche	120x7x3cm 47 1/4"x2 3/4"x1 1/8"	100176745 L167012678	G-163	2 x Cj 200 x Pal	0,17 x Cj 16,80 x Pal	3,28 x Cj 327,80 x Pal	



Style 1L Soft



Description	Format	Codes	Group	Pcs	m2	Kg
AC4 Style 1L Soft	19,05x126,1x0,7cm	100199511	G-204	10 x Cj	2,40 x Cj	16,48 x Cj
	7 1/2"x49 5/8"x1/4"	L167012876		480 x Pal	115,30 x Pal	791,04 x Pal
Skirting / Zócalo / Plinthe	8x220x1,4cm	100162143	G-107	12 x Cj	2,16 x Cj	19,45 x Cj
	3 1/8"x88 5/8"x1/2"	L167012591		696 x Pal	125,28 x Pal	1128,21 x Pal
Levelling Profile / Perfil Igualación / Profilé Égalisation	4x270x1cm	100162127	G-155	20 x Cj	2,16 x Cj	15,38 x Cj
	1 3/4"x106 1/4"x3/8"	L167012590		1000 x Pal	108 x Pal	769 x Pal
Transition Profile / Perfil Transición / Profilé Jointoiment	4x270x1cm	100162135	G-155	20 x Cj	2,16 x Cj	15,38 x Cj
	1 3/4"x106 1/4"x3/8"	L167012589		1000 x Pal	108 x Pal	796 x Pal
Stair Nosing / Mampelran / Nez de Marche	120x7x3cm	100176756	G-163	2 x Cj	0,17 x Cj	3,28 x Cj
	47 1/4"x2 3/4"x1 1/8"	L167012681		200 x Pal	16,80 x Pal	327,80 x Pal

STOCK



Revelation

—
Yellowstone
Yosemite
Everglades
Katmai





Revelation 1L
Yellowstone



Description	Format	Codes	Group	Pcs	m2	Kg
ACS Revelation 1L Yellowstone	16x128,7x1cm	100173877	G-213	8 x Cj	1,64 x Cj	12,65 x Cj
	6 1/4"x50 5/8"x3/8"	L167012649		400 x Pal	82,37 x Pal	632,80 x Pal
Skirting / Zócalo / Plinthe	8x220x1,4cm	100222942	G-107	14 x Cj	2,46 x Cj	36,43 x Cj
	3 1/8"x86 5/8"x9/16"	L167012940		560 x Pal	98,56 x Pal	1457,12 x Pal
Transition Profile / Perfil Transición / Profilé Jointoiment	4x270x1cm	100146805	G-155	20 x Cj	0,22 x Cj	15,92 x Cj
	1 3/4"x106 1/4"x3/8"	L167012423		1000 x Pal	10,80 x Pal	796 x Pal
Levelling Profile / Perfil Igualación / Profilé Égalisation	4x270x1cm	100146811	G-155	20 x Cj	0,22 x Cj	15,92 x Cj
	1 3/4"x106 1/4"x3/8"	L167012422		1000 x Pal	10,80 x Pal	796 x Pal
Stair Nosing / Mampelan / Nez de Marche	120x7x3cm	100176770	G-163	2 x Cj	0,17 x Cj	3,28 x Cj
	47 1/4"x2 3/4"x1 1/8"	L167012689		200 x Pal	16,80 x Pal	327,80 x Pal



Revelation 1L
Yosemite



Description	Format	Codes	Group	Pcs	m2	Kg
ACS Revelation 1L Yosemite	16x128,7x1cm	100173878	G-213	8 x Cj	1,64 x Cj	12,65 x Cj
	6 1/4"x50 5/8"x3/8"	L167012652		400 x Pal	82,37 x Pal	632,80 x Pal
Skirting / Zócalo / Plinthe	8x220x1,4cm	100174162	G-107	14 x Cj	2,46 x Cj	36,43 x Cj
	3 1/8"x86 5/8"x9/16"	L167012660		560 x Pal	98,56 x Pal	1457,12 x Pal
Transition Profile / Perfil Transición / Profilé Jointoiment	4x270x1cm	100146806	G-155	20 x Cj	0,22 x Cj	15,92 x Cj
	1 3/4"x106 1/4"x3/8"	L167012412		1000 x Pal	10,80 x Pal	796 x Pal
Levelling Profile / Perfil Igualación / Profilé Égalisation	4x270x1cm	100146812	G-155	20 x Cj	0,22 x Cj	15,92 x Cj
	1 3/4"x106 1/4"x3/8"	L167012406		1000 x Pal	10,80 x Pal	796 x Pal
Stair Nosing / Mampelan / Nez de Marche	120x7x3cm	100176767	G-163	2 x Cj	0,17 x Cj	3,28 x Cj
	47 1/4"x2 3/4"x1 1/8"	L167012690		200 x Pal	16,80 x Pal	327,80 x Pal

Revelation



Revelation 1L Everglades



Description	Format	Codes	Group	Pcs	m2	Kg
AC5 Revelation 1L Everglades	16x128,7x1cm	100173875	G-213	8 x Cj	1,64 x Cj	12,65 x Cj
	6 1/4"x50 5/8"x3/8"	L167012650		400 x Pal	82,37 x Pal	632,80 x Pal
Skirting / Zócalo / Plinthe	8x220x1,4cm	100174156	G-107	12 x Cj	2,11 x Cj	31,22 x Cj
	3 1/8"x86 5/8"x9/16"	L167012657		600 x Pal	105,60 x Pal	1561,20 x Pal
Transition Profile / Perfil Transición / Profilé Jointolement	4x270x1cm	100146708	G-155	20 x Cj	0,22 x Cj	15,92 x Cj
	1 3/4"x106 1/4"x3/8"	L167012402		1000 x Pal	10,80 x Pal	796 x Pal
Levelling Profile / Perfil Igualación / Profilé Égalisation	4x270x1cm	100146802	G-155	20 x Cj	0,22 x Cj	15,92 x Cj
	1 3/4"x106 1/4"x3/8"	L167012410		1000 x Pal	10,80 x Pal	796 x Pal
Stair Nosing / Mampelan / Nez de Marche	120x7x3cm	100176766	G-163	2 x Cj	0,17 x Cj	3,28 x Cj
	47 1/4"x2 3/4"x1 1/8"	L167012687		200 x Pal	16,80 x Pal	327,80 x Pal



Revelation 1L Katmai



Description	Format	Codes	Group	Pcs	m2	Kg
AC5 Revelation 1L Katmai	16x128,7x1cm	100173876	G-213	8 x Cj	1,64 x Cj	12,65 x Cj
	6 1/4"x50 5/8"x3/8"	L167012651		400 x Pal	82,37 x Pal	632,80 x Pal
Skirting / Zócalo / Plinthe	8x220x1,4cm	100174136	G-107	12 x Cj	2,11 x Cj	31,22 x Cj
	3 1/8"x86 5/8"x9/16"	L167012656		600 x Pal	105,60 x Pal	1561,20 x Pal
Transition Profile / Perfil Transición / Profilé Jointolement	4x270x1cm	100146709	G-155	20 x Cj	0,22 x Cj	15,92 x Cj
	1 3/4"x106 1/4"x3/8"	L167012409		1000 x Pal	10,80 x Pal	796 x Pal
Levelling Profile / Perfil Igualación / Profilé Égalisation	4x270x1cm	100146803	G-155	20 x Cj	0,22 x Cj	15,92 x Cj
	1 3/4"x106 1/4"x3/8"	L167012415		1000 x Pal	10,80 x Pal	796 x Pal
Stair Nosing / Mampelan / Nez de Marche	120x7x3cm	100176758	G-163	2 x Cj	0,17 x Cj	3,28 x Cj
	47 1/4"x2 3/4"x1 1/8"	L167012688		200 x Pal	16,80 x Pal	327,80 x Pal





Endless

—
Queens
Brooklyn
Brooklyn
Long Island



Endless 1L
Queens



Description	Format	Codes	Group	Pcs	m2	Kg
AC4 Endless 1L Queens	24.4x126.1x0.8cm 9 5/8"x49 5/8"x3/8"	100199486 L167012874	G-210	8 x Cj 240 x Pal	2,46 x Cj 73,84 x Pal	18,11 x Cj 543,36 x Pal
Skirting / Zócalo / Plinthe	8x220x1,5cm 3 1/8"x86 5/8"x5/8"	100153895 L167012480	G-107	14 x Cj 560 x Pal	2,46 x Cj 98,56 x Pal	22,69 x Cj 907,76 x Pal
Transition Profile / Perfil Transición / Profilé Jointoiment	4x270x1cm 1 3/4"x106 1/4"x3/8"	100153888 L167012516	G-155	20 x Cj 1000 x Pal	0,22 x Cj 10,80 x Pal	15,92 x Cj 769 x Pal
Levelling Profile / Perfil Igualación / Profilé Égalisation	4x270x1cm 1 3/4"x106 1/4"x3/8"	100153881 L167012510	G-155	20 x Cj 1000 x Pal	2,16 x Cj 108 x Pal	15,92 x Cj 796 x Pal
Stair Nosing / Mampelan / Nez de Marche	120x7x3cm 47 1/4"x2 3/4"x1 1/8"	100176687 L167012694	G-163	2 x Cj 200 x Pal	0,17 x Cj 16,80 x Pal	3,28 x Cj 327,80 x Pal

STOCK



Endless 1L
Broadway



Description	Format	Codes	Group	Pcs	m2	Kg
AC4 Endless 1L Broadway	24.4x126.1x0.8cm 9 5/8"x49 5/8"x3/8"	100199463 L167012873	G-210	8 x Cj 240 x Pal	2,46 x Cj 73,84 x Pal	18,11 x Cj 543,36 x Pal
Skirting / Zócalo / Plinthe	8x220x1,5cm 3 1/8"x86 5/8"x5/8"	100153892 L167012482	G-107	14 x Cj 560 x Pal	2,46 x Cj 98,56 x Pal	22,69 x Cj 907,76 x Pal
Transition Profile / Perfil Transición / Profilé Jointoiment	4x270x1cm 1 3/4"x106 1/4"x3/8"	100153885 L167012515	G-155	20 x Cj 1000 x Pal	0,22 x Cj 10,80 x Pal	15,92 x Cj 769 x Pal
Levelling Profile / Perfil Igualación / Profilé Égalisation	4x270x1cm 1 3/4"x106 1/4"x3/8"	100153848 L167012512	G-155	20 x Cj 1000 x Pal	2,16 x Cj 108 x Pal	15,92 x Cj 796 x Pal
Stair Nosing / Mampelan / Nez de Marche	120x7x3cm 47 1/4"x2 3/4"x1 1/8"	100176686 L167012696	G-163	2 x Cj 200 x Pal	0,17 x Cj 16,80 x Pal	3,28 x Cj 327,80 x Pal

Endless



Endless 1L Brooklyn



Description	Format	Codes	Group	Pcs	m2	Kg	
AC4 Endless 1L Brooklyn	24,4x126,1x0,8cm 9 5/8"x49 5/8"x3/8"	100199491 L167012872	G-210	8 x Cj 240 x Pal	2,46 x Cj 73,84 x Pal	18,11 x Cj 543,36 x Pal	STOCK
Skirting / Zócalo / Plinthe	8x220x1,5cm 3 1/8"x86 5/8"x5/8"	100153893 L167012479	G-107	14 x Cj 560 x Pal	2,46 x Cj 98,56 x Pal	22,69 x Cj 907,76 x Pal	
Transition Profile / Perfil Transición / Profilé Jointolement	4x270x1cm 1 3/4"x106 1/4"x3/8"	100153886 L167012514	G-155	20 x Cj 1000 x Pal	0,22 x Cj 10,80 x Pal	15,92 x Cj 769 x Pal	
Levelling Profile / Perfil Igualación / Profilé Égalisation	4x270x1cm 1 3/4"x106 1/4"x3/8"	100153849 L167012511	G-155	20 x Cj 1000 x Pal	2,16 x Cj 108 x Pal	15,92 x Cj 796 x Pal	
Stair Nosing / Mampelran / Nez de Marche	120x7x3cm 47 1/4"x2 3/4"x1 1/8"	100176679 L167012697	G-163	2 x Cj 200 x Pal	0,17 x Cj 16,80 x Pal	3,28 x Cj 327,80 x Pal	



Endless 1L Long Island



Description	Format	Codes	Group	Pcs	m2	Kg	
AC4 Endless 1L Long Island	24,4x126,1x0,8cm 9 5/8"x49 5/8"x3/8"	100199485 L167012875	G-210	8 x Cj 240 x Pal	2,46 x Cj 73,84 x Pal	18,11 x Cj 543,36 x Pal	STOCK
Skirting / Zócalo / Plinthe	8x220x1,5cm 3 1/8"x86 5/8"x5/8"	100153894 L167012483	G-107	14 x Cj 560 x Pal	2,46 x Cj 98,56 x Pal	22,69 x Cj 907,76 x Pal	
Transition Profile / Perfil Transición / Profilé Jointolement	4x270x1cm 1 3/4"x106 1/4"x3/8"	100153887 L167012517	G-155	20 x Cj 1000 x Pal	0,22 x Cj 10,80 x Pal	15,92 x Cj 769 x Pal	
Levelling Profile / Perfil Igualación / Profilé Égalisation	4x270x1cm 1 3/4"x106 1/4"x3/8"	100153880 L167012513	G-155	20 x Cj 1000 x Pal	2,16 x Cj 108 x Pal	15,92 x Cj 796 x Pal	
Stair Nosing / Mampelran / Nez de Marche	120x7x3cm 47 1/4"x2 3/4"x1 1/8"	100176700 L167012692	G-163	2 x Cj 200 x Pal	0,17 x Cj 16,80 x Pal	3,28 x Cj 327,80 x Pal	

Genuine

—
Mojave
Sonoran
Great Basin





**Genuine 1L
Mojave**

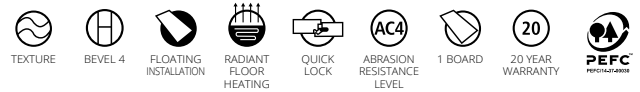

Description	Format	Codes	Group	Pcs	m2	Kg
AC4 Genuine 1L Mojave	19x125,7x0,8cm 7 1/2"x49 1/2"x3/8"	100173109 L165003583	G-210	9 x Cj 432 x Pal	2,15 x Cj 103,17 x Pal	15,86 x Cj 761,18 x Pal
White Skirting / Zócalo Blanco / Plinthe Blanc	8x220x1,5cm 3 1/8"x86 5/8"x5/8"	100155425 L167012495	G-107	14 x Cj 560 x Pal	2,46 x Cj 98,56 x Pal	19,32 x Cj 772,80 x Pal
Aluminium Transition Profile / Perfil Transición Aluminio / Profilé jointoiment Aluminium	4x270x1cm 1 5/8"x106 1/4"x3/8"	100174612 L167012667	G-155	10 x Cj 1000 x Pal	1,08 x Cj 108,0 x Pal	10,20 x Cj 1020 x Pal
Aluminium Levelling Profile / Perfil Igualación Aluminio / Profilé Egalisation Aluminium	4,5x270x1cm 1 3/4"x106 1/4"x3/8"	100174623 L167012666	G-155	10 x Cj 1000 x Pal	1,08 x Cj 108,0 x Pal	10,20 x Cj 1020 x Pal

*Strong color variation / Variación de tono fuerte / Forte variation de tonalité.



**Genuine 1L
Sonoran**

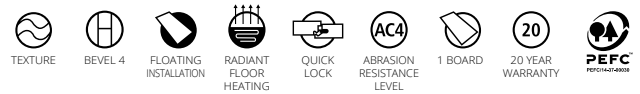

Description	Format	Codes	Group	Pcs	m2	Kg
AC4 Genuine 1L Sonoran	19x125,7x0,8cm 7 1/2"x49 1/2"x3/8"	100173142 L165003584	G-210	9 x Cj 432 x Pal	2,15 x Cj 103,17 x Pal	15,86 x Cj 761,18 x Pal
White Skirting / Zócalo Blanco / Plinthe Blanc	8x220x1,5cm 3 1/8"x86 5/8"x5/8"	100155425 L167012495	G-107	14 x Cj 560 x Pal	2,46 x Cj 98,56 x Pal	19,32 x Cj 772,80 x Pal
Aluminium Transition Profile / Perfil Transición Aluminio / Profilé jointoiment Aluminium	4x270x1cm 1 5/8"x106 1/4"x3/8"	100174612 L167012667	G-155	10 x Cj 1000 x Pal	1,08 x Cj 108,0 x Pal	10,20 x Cj 1020 x Pal
Aluminium Levelling Profile / Perfil Igualación Aluminio / Profilé Egalisation Aluminium	4,5x270x1cm 1 3/4"x106 1/4"x3/8"	100174623 L167012666	G-155	10 x Cj 1000 x Pal	1,08 x Cj 108,0 x Pal	10,20 x Cj 1020 x Pal

*Strong color variation / Variación de tono fuerte / Forte variation de tonalité.

Genuine



Genuine 1L Great Basin

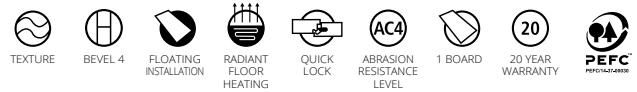

Description	Format	Codes	Group	Pcs	m2	Kg
AC4 Genuine 1L Great Basin	19x125,7x0,8cm	100173150	G-210	9 x Cj	2,15 x Cj	15,86 x Cj
	7 1/2"x49 1/2"x3/8"	L165003585		432 x Pal	103,17 x Pal	761,18 x Pal
White Skirting / Zócalo Blanco / Plinthe Blanc	8x220x1,5cm	100155425	G-107	14 x Cj	2,46 x Cj	19,32 x Cj
	3 1/8"x86 5/8"x5/8"	L167012495		560 x Pal	98,56 x Pal	772,80 x Pal
Aluminium Transition Profile / Perfil Transición Aluminio / Profilé Jointoiment Aluminium	4x270x1cm	100174612	G-155	10 x Cj	1,08 x Cj	10,20 x Cj
	1 5/8"x106 1/4"x3/8"	L167012667		1000 x Pal	108,0 x Pal	1020 x Pal
Aluminium Levelling Profile / Perfil Igualación Aluminio / Profilé Égalisation Aluminium	4,5x270x1cm	100174623	G-155	10 x Cj	1,08 x Cj	10,20 x Cj
	1 3/4"x106 1/4"x3/8"	L167012666		1000 x Pal	108,0 x Pal	1020 x Pal

*Strong color variation / Variación de tono fuerte / Forte variation de tonalité.



Laminate Flooring

Floor Coverings AC4 Genuine 1L Great Basin



Quercus

—
Brown
Light Grey
Natural



**Quercus 1L
Brown**

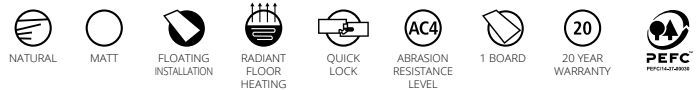

Description	Format	Codes	Group	Pcs	m2	Kg
AC4 Quercus 1L Brown	15,9x138,3x0,8cm 6 1/4"x54 1/2"x3/8"	100203096 L165003940	G-210	10 x Cj 480 x Pal	2,20 x Cj 105,55 x Pal	15 x Cj 720 x Pal
Skirting / Zócalo / Plinthe	8x220x1,4cm 3 1/8"x86 5/8"x1/2"	100203512 L165003947	G-107	14 x Cj 560 x Pal	2,46 x Cj 98,56 x Pal	36,42 x Cj 1457,12 x Pal
Levelling Profile / Perfil Igualación / Profilé Égalisation	4x270x1cm 1 3/4"x106 1/4"x3/8"	100203491 L165003953	G-155	20 x Cj 1000 x Pal	2,16 x Cj 108 x Pal	15,92 x Cj 796 x Pal
Transition Profile / Perfil Transición / Profilé Jointoiment	4x270x1cm 1 3/4"x106 1/4"x3/8"	100203521 L165003948	G-155	20 x Cj 1000 x Pal	2,16 x Cj 108 x Pal	15,92 x Cj 796 x Pal
Stair Nosing / Mampelran / Nez de Marche	120x7x3cm 47 1/4"x2 3/4"x1 1/8"	100203492 L165003955	G-163	2 x Cj 200x Pal	0,16 x Cj 16,80 x Pal	3,27 x Cj 327,80 x Pal

NEW



**Quercus 1L
Light Grey**

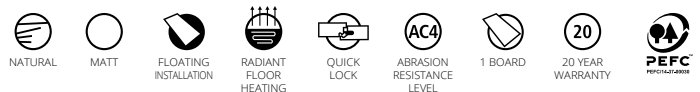

Description	Format	Codes	Group	Pcs	m2	Kg
AC4 Quercus 1L Light Grey	15,9x138,3x0,8cm 6 1/4"x54 1/2"x3/8"	100203105 L165003941	G-210	10 x Cj 480 x Pal	2,20 x Cj 105,55 x Pal	15,60 x Cj 748,80 x Pal
Skirting / Zócalo / Plinthe	8x220x1,4cm 3 1/8"x86 5/8"x1/2"	100203503 L165003943	G-107	14 x Cj 560 x Pal	2,46 x Cj 98,56 x Pal	36,42 x Cj 1457,12 x Pal
Levelling Profile / Perfil Igualación / Profilé Égalisation	4x270x1cm 1 3/4"x106 1/4"x3/8"	100203501 L165003944	G-155	20 x Cj 1000 x Pal	2,16 x Cj 108 x Pal	15,92 x Cj 796 x Pal
Transition Profile / Perfil Transición / Profilé Jointoiment	4x270x1cm 1 3/4"x106 1/4"x3/8"	100203511 L165003949	G-155	20 x Cj 1000 x Pal	2,16 x Cj 108 x Pal	15,92 x Cj 796 x Pal
Stair Nosing / Mampelran / Nez de Marche	120x7x3cm 47 1/4"x2 3/4"x1 1/8"	100203502 L165003946	G-163	2 x Cj 200x Pal	0,16 x Cj 16,80 x Pal	3,27 x Cj 327,80 x Pal

NEW

Quercus



Quercus 1L Natural

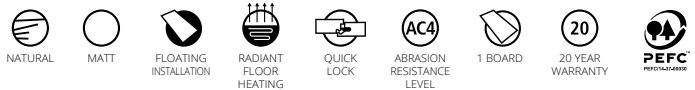

Description	Format	Codes	Group	Pcs	m2	Kg
AC4 Quercus 1L Natural	15,9x138,3x0,8cm	100203114	G-210	10 x Cj	2,20 x Cj	15,80 x Cj
	6 1/4"x54 1/2"x3/8"	L165003942		480 x Pal	105,55 x Pal	758,40 x Pal
Skirting / Zócalo / Plinthe	8x220x1,4cm	100203513	G-107	14 x Cj	2,46 x Cj	36,42 x Cj
	3 1/8"x86 5/8"x1/2"	L165003950		560 x Pal	98,56 x Pal	1457,12 x Pal
Levelling Profile / Perfil Igualación / Profilé Égalisation	4x270x1cm	100203510	G-155	20 x Cj	2,16 x Cj	15,92 x Cj
	1 3/4"x106 1/4"x3/8"	L165003956		1000 x Pal	108 x Pal	796 x Pal
Transition Profile / Perfil Transición / Profilé Jointoiment	4x270x1cm	100203493	G-155	20 x Cj	2,16 x Cj	15,92 x Cj
	1 3/4"x106 1/4"x3/8"	L165003958		1000 x Pal	108 x Pal	796 x Pal
Stair Nosing / Mamporan / Nez de Marche	120x7x3cm	100203520	G-163	2 x Cj	0,16 x Cj	3,27 x Cj
	47 1/4"x2 3/4"x1 1/8"	L165003945		200x Pal	16,80 x Pal	327,80 x Pal

NEW



Floor Coverings AC4 Quercus 1L Brown



**Antistatic Underfloor Heating Layer
Lamina Suelo Radiante Antiestática
Sous-Couche Plancher Rayonnant Antistatique**

25m² - 100175300 - L165003722 - G-169

A lining made of recycled closed-cell rubber with an aluminium layer that dissipates heat and eliminates static electricity. This protection can be used over underfloor heating and reduces impact noise by 26dB airborne noise by 22dB.

Lámina realizada con caucho reciclado de celda cerrada que cuenta con una capa de aluminio capaz de repartir el calor y eliminar la electricidad estática. Esta protección se puede utilizar sobre suelo radiante y reduce el sonido de impacto en 26dB y el aéreo en 22dB.

Sous-couche en caoutchouc recyclé à cellules fermées composée d'une couche d'aluminium capable de répartir la chaleur et d'éliminer l'électricité statique. Cette protection peut être utilisée sous un plancher rayonnant, elle réduit les sons d'impact de 26dB et les sons aériens de 22dB.



**Sous-Couche Anti-Humidité + Mousse
Lamina Antihumedad + Espuma
Damp Proofing Sheet + Foam**

22m² - 100169988 - L180112046 - G-151

140m² - 100170010 - L180112045 - G-169

Sound insulation and damp proofing for parquet and laminate flooring.

Aislante acústico y antihumedad para el parquet y el laminado.

Isolant phonique et anti-humidité pour les parquets et les planchers stratifiés.



**Insulating Layer
Lamina Aislante
Sous-Couche Isolante**

79x59x0,5cm - 100059778 - L180112013 - G-104

5mm-thick sound insulation useful for rectifying uneven patches.

Aislante acústico de 5 mm de grosor, útil para corregir desniveles.

Isolant phonique de 5 mm d'épaisseur, utile pour compenser des différences de niveaux.

Cleaner / Limpiador / Nettoyants



Intensive maintenance and cleaning laminate wood.

Mantenimiento laminado y limpieza intensiva de maderas.

Entretien et nettoyage intensif de bois stratifié.

Clean and Green Active 0,5 L

100148087 - L167012432 - G-128

Thinning / Dilución / Dilution 1:200
Coverage / Rendimiento / Rendement 1500 m²/L

Special Pieces / Piezas Especiales / Pièces Spéciales



Aluminium Transition Profile
Perfil Transición Aluminio
Profilé De Jointoiment Aluminium

4x270x1cm - 1 5/8"x106 1/4"x3/8"
100174612 - L167012667 - G-155



Aluminium Levelling Profile
Perfil Igualación Aluminio
Profilé D'égalisation Aluminium

4,5x270x1cm - 1 3/4"x106 1/4"x3/8"
100174623 - L167012666 - G-155



White Skirting
Zocalo Blanco
Plinthe Blanc

8x220x1,5cm - 3 1/8"x86 5/8"x5/8"
100155425 - L167012495 - G-107



Stair Nosing
Mamperlan
Nez de Marche

120x7x3cm - 47 1/4"x2 3/4"x1 1/8"

The nosing can be made with two different locking systems: Quick Lock or Lock. These pieces are made with the same base as the laminate with mitered slats.

El mamperlán puede estar realizado con dos sistemas diferentes de unión: Quick Lock o Lock. Estas piezas están realizadas con la misma base que el Laminado ingletando lamas.

Le nez de marche peut être réalisé avec deux systèmes d'assemblage différents: Quick Lock ou Lock. Ces pièces sont fabriquées avec la même base que le stratifié avec des coupes d'onglets sur les lames.

BEFORE INSTALLING

ANTES DE INSTALAR

AVANT DE L'INSTALLATION



1. Receiving and storage: verify the material and the installation location.

1. Recepción y almacenaje: verificar material y lugar de la instalación.

1. Réception et stockage: vérifier le matériel et le lieu de l'installation.



2. Climatic conditions: Temp. 20-23°C/65-80°F; 40-60% relative humidity.

2. Condiciones climáticas: T° 20-23°C/65-80°F; Humedad relativa 40-60%.

2. Conditions climatiques: Température: 20-23°C/65-80°F; humidité relative: 40-60%.

3. Subfloor

3. Subsuelo

3. Sous-sol



Measure humidity with a hygrometer. Max 2,5%.

Medir humedad con un higrómetro. Max 2,5%.

Mesurer l'humidité avec un hygromètre. Max 2,5%.

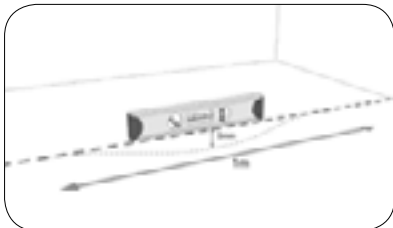

Flatness and horizontality: max. deflections admitted, 5mm and 1mm.

Planimetría y horizontalidad: como max. flechas de 5mm y 1mm.

Planimétrie et horizontalité: avec des flèches d'un maximum de 5mm et 1mm.



3.1 Cleaning: clean base slab, and free from elements.

3.1 Limpieza: solera limpia y libre de elementos.

3.1 Nettoyage: lisse de terre propre et dépourvue d'éléments.



4. Direction of the installation: Boards arranged longitudinally in relation to the main light source.

4. Sentido de la instalación: lamas dispuestas en sentido longitudinal con respecto a la fuente de luz principal.

4. Sens de l'installation: lames disposées en sens longitudinal par rapport à la source de lumière principale.

5. Planning the installation

5. Planificación de la instalación

5. Planification de l'installation

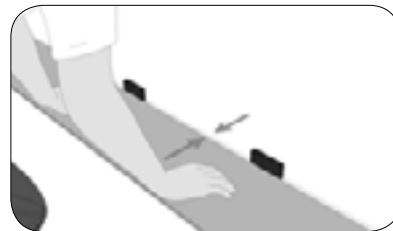

5.1 Perimeter joint: leave at least 1cm.

5.1 Junta perimetral: dejar como mínimo 1cm.

5.1 Joint périphérique: laisser minimum 1cm.

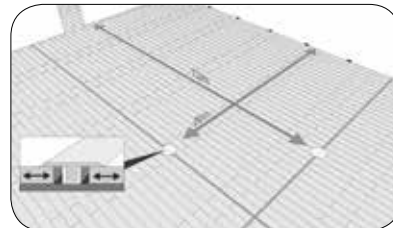

5.2 Expansion joints, lengthwise every 12m and cross-wise every 8m. Minimum width 15mm. Where

to install them: start of corridors, doorway areas, narrowing between partition walls that separate one single space.

5.2 Juntas de expansión cada 12m longitudinales y 8 transversales. Ancho mínimo 15mm. Lugares para colocar los arranques de pasillos, zonas de paso de puertas, estrechamientos entre tabiques que separan un mismo espacio.

5.2 Joints de dilatation tous les 12m longitudinaux et 8m transversaux. Largeur minimale : 15mm. Lieux pour la mise en place des naissances des couloirs, des zones de passage des portes, des rétrécissements entre les cloisons qui séparent une même pièce.

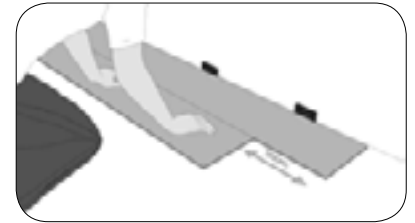

5.3 Offset: the installation shall advance so that the ends of each board are separated at least 30cm from the next one.

5.3 Decalaje: la colocación debe progresar de forma que los extremos de cada tabla queden separados respecto a la siguiente de 30cm.

5.3 Décalage: lors de la pose, les extrémités de chaque planche doivent être séparées de 30cm par rapport à la suivante.



5.4 Skirting boards nailed to the wall using a pneumatic gun.

5.4 Zócalos clavados a la pared mediante pistola neumática.

5.4 Socles cloués au mur avec une cloueuse à air comprimé.

INSTALLATION

INSTALACIÓN

INSTALLATION

1. Floating system

1. Sistema flotante

1. Système flottant



Installation / Instalación / Installation

1.1. We recommend installing the L'Antic Colonial sheet, whether it is the moisture barrier+foam sheet or the antistatic radiant-floor film.

1.1 Se recomienda la instalación de la lámina de L'Antic Colonial. Ya sea la lámina anti-humedad+ espuma o la lámina de suelo radiante antiestática.

1.1 Il est recommandé d'installer la lame de L'Antic Colonial. Soit la lame anti-humidité + mousse, soit la lame de plancher rayonnant anti-statique.

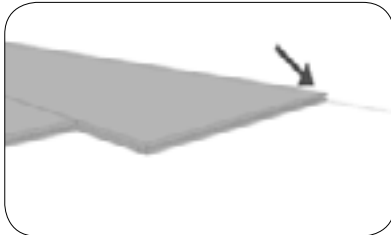

1.2 Start the installation always with the female toward the wall. Minimum distance of 10mm using wedges.

1.2 Iniciar instalación con las hembras hacia la pared. Distancia mínima de 10mm mediante cuñas.

1.2 Commencer l'installation avec les femelles vers le mur. Distance minimale : 10 mm avec des cales.

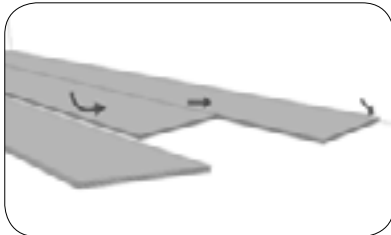

1.3 On the third board and the rest, use the same installation method. The first rows shall be perfectly straight and be parallel. Check with the ruler.

1.3 En la tercera lama y las siguientes deberá efectuar la misma colocación. Las primeras hileras tienen que estar rigurosamente rectas y ser paralelas. Controlar con la regla.

1.3 Vous devez effectuer la même pose à la troisième lame et les suivantes. Les premières files doivent être rigoureusement droites et être parallèles. Le contrôler avec la règle.

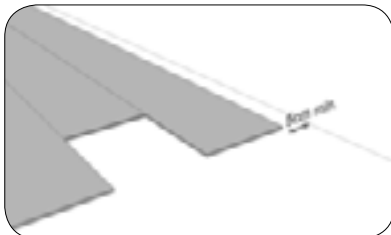

1.4 Measure installation area, because the width of the boards on the last row cannot be under 5cm. Take into account the 10mm minimum distance to the wall.

1.4 Medir área de instalación ya que el ancho de las lamas de la última

hileras no debe ser inferior a 5cm. Tener en cuenta la distancia mínima con la pared de 10mm.

1.4 Mesurer l'aire d'installation; la largeur des lames de la dernière file ne doit pas être inférieure à 5cm. Prendre en considération la distance minimale avec le mur de 10mm.

2. Radiant floor heating

2. Suelo radiante

2. Plancher rayonnant

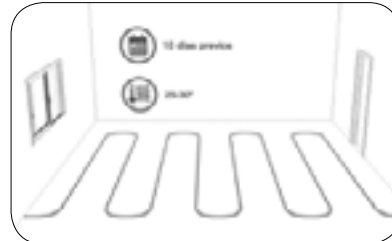

2.1 Turn on the radiant system to 25-30°C, 10 days before installing.

2.1 Encender el sistema radiante 10 días previos a la instalación a 25-30°C.

2.1 Allumer le système de chauffage rayonnant 10 jours avant l'installation à 25-30°C.

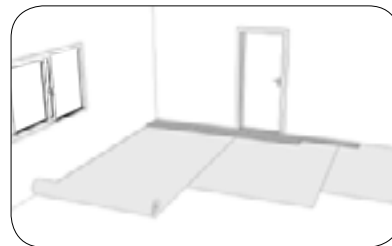

2.2. We recommend installing the L'Antic Colonial antistatic radiant-floor film.

2.2 Se recomienda la instalación de la lámina para suelo radiante antiestática de L'Antic Colonial.

2.2 Il est recommandé d'installer la lame pour plancher rayonnant anti-statique de L'Antic Colonial.



2.3. Once the floor is installed, increase the temperature by 2-3°C per day until reaching the maximum temperature (27-28°C).

2.3 Una vez instalado el pavimento incrementar la Tº 2-3°C al día hasta llegar al máximo (27-28°C).

2.3 Après l'installation du revêtement pour le sol, augmenter la température entre 2 et 3°C chaque jour jusqu'à atteindre la température maximale (27-28°C).



2.4 Once the max temperature is reached (27-28°C,) it must be maintained one day per cm of thickness of the sub-floor (overnight).

2.4 Una vez alcanzada la Tº max (27-28°C) mantener un día por cada cm de espesor del subsuelo (por la noche).

2.4 Dès que la température maximale (27-28°C) est atteinte, la maintenir une journée pour chaque centimètre d'épaisseur du sous-sol (la nuit).

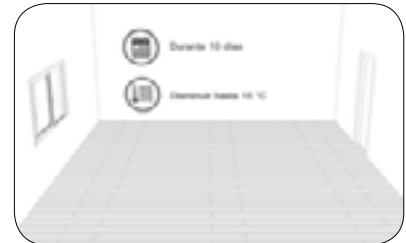

2.5 Lastly, the temperature must be lowered 2-3°C until the floor reaches 15°C (about 10 days.)

2.5 Por último, disminuir la Tº 2-3°C hasta que el suelo alcance los 15°C (unos 10 días).

2.5 Finalement, diminuer la température entre 2 et 3°C jusqu'à ce que la température du sol arrive à 15°C (environ 10 jours).

You can see these updated installation instructions by visiting our website www.anticcolonial.com

Puedes revisar estas instrucciones de instalación actualizadas y con más detalle visitando nuestra página web www.anticcolonial.com

Pour réviser ces instructions d'installation, mises à jour et plus détaillées, veuillez visiter notre site Internet www.anticcolonial.com

08

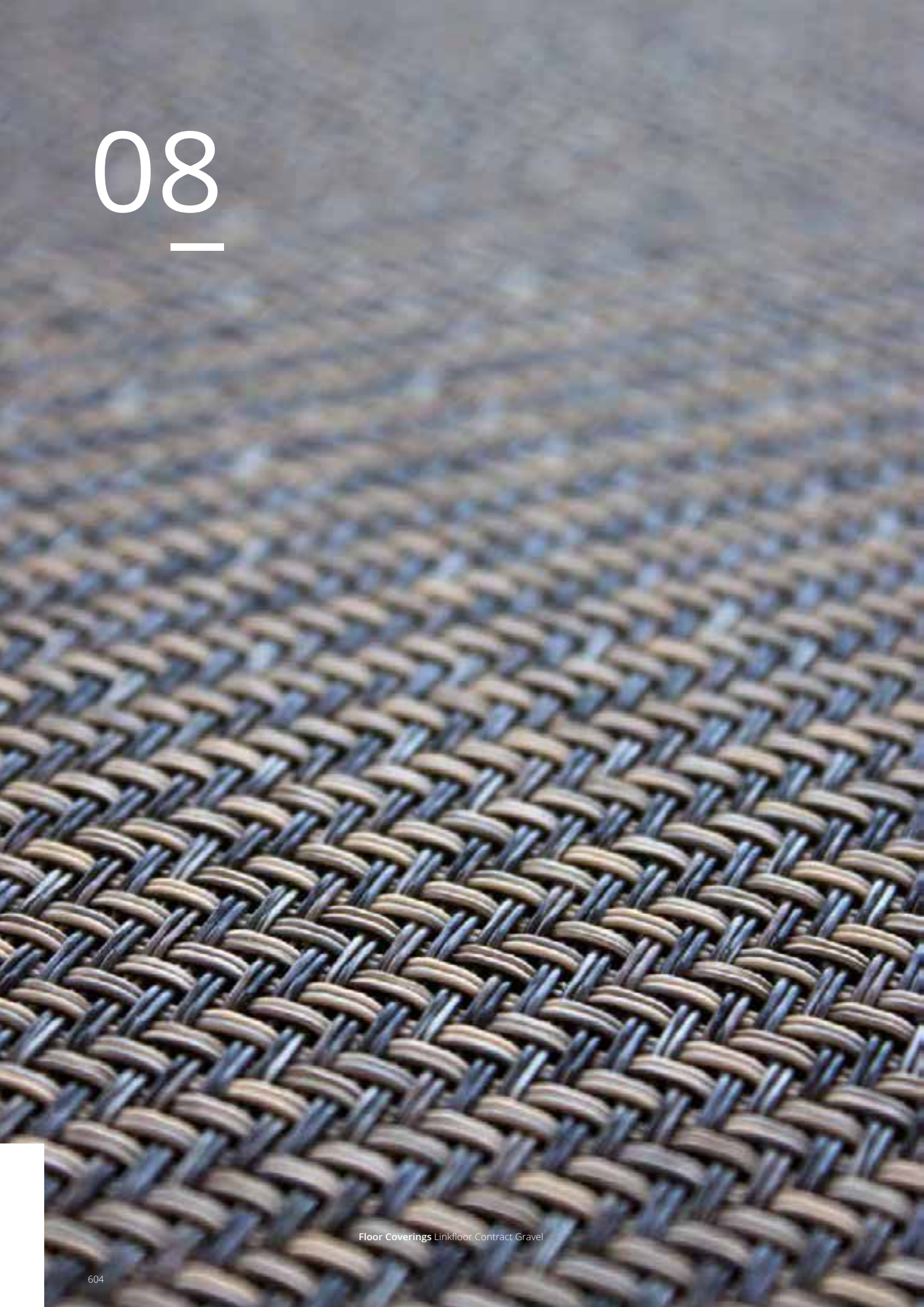

Linkfloor

Linkfloor

These products may be subject to variations in shade. The colour of the material supplied may differ slightly from that shown. Our website (<http://anticcolonial.com/en/linkfloor/>) contains further information in respect of our products, such as installation guides and videos, technical specifications, details on textures, recommendations for use and maintenance.

Estos modelos pueden sufrir variaciones de tono. El color del material servido puede no ser exactamente igual al de la muestra. En nuestra página web (<http://anticcolonial.com/linkfloor/>) encontrará información adicional de nuestros productos como guías y vídeos de instalación, fichas técnicas, consejos para su mantenimiento, texturas o recomendaciones de uso.

Ces modèles peuvent subir des variations de tonalité. La couleur du matériau fourni peut être légèrement différente de celle de l'échantillon. Sur notre site Internet (<http://anticcolonial.com/fr/linkfloor/>), vous trouverez des informations supplémentaires sur nos produits : manuels et vidéos d'installations, fiches techniques, conseils pour l'entretien, textures ou recommandations d'utilisation.

**CONTRACT**

An extremely tough imitation of braided textile.

Simulación de material textil trenzado de gran resistencia.

Imitation de matériel textile tressé haute résistance.

**ROLL CONTRACT**

Imitation woven textile effect, in a bonded 2 x 10 metres roll.

Simulación de material textil trenzado, montado sobre un formato enrollado de 2 x 10 metros.

Imitation de matériau textile tressé, monté sur un format enroulé de 2 x 10 mètres.

**WALL CONTRACT**

Designed to be installed on walls, ceilings and furniture. It is produced in roll format, 30 meters long and 1 meter width.

Diseñado para ser aplicado sobre paramentos verticales, techos y muebles. Tiene un formato de 30 metros de largo por 1 metro de ancho.

Conçu pour être appliqué sur les parements verticaux, les plafonds et les meubles. Il est fabriqué en format de 30 mètres de longueur sur 1 mètre de largeur.

**WALL CONTRACT CUSTOM**

A custom image is included via digital printing which blends perfectly with the vinyl fabric. Size 98x300cm

Se incorpora una imagen personalizada mediante impresión digital que se funde a la perfección con el tejido vinílico. Formato de 98x300cm.

Une image personnalisée est intégrée par impression numérique pour se fondre à la perfection avec le tissu vinylique. Format de 98x300 cm

Collections / Colecciones / Collections



LOOSE LAY CONTRACT

4.2mm thick 50x50cm pieces. Textile feeling with all the benefits of vinyl.

Láminas de 50x50cm con espesor de 4,2 mm. Proporciona la sensación del textil y todas las ventajas del vinilo.

Dalles de 50x50cm et d'une épaisseur de 4,2 mm. Elles apportent l'agréable sensation d'un textile en ayant tous les avantages du vinyle.



OAK

Water-resistant and easy to lay, it imitates a natural wood finish.

Aspecto de madera natural, resistente al agua y de fácil instalación.

Aspect du bois naturel, résistant à l'eau et facile à poser.



HOTEL AIR

The look of brushed wood in a 100% waterproof floor.

Aspecto de madera cepillada y 100% resistente al agua.

Aspect du bois raboté et 100% résistant à l'eau.



EMPIRE

Vinyl material which simulates wood and is highly water resistant. Empire has a large size of 22.8x180cm.

Material vinílico que simula la madera y posee gran resistencia al agua. Empire cuenta con un gran formato de 22,8x180cm.

Matériau vinyle effet bois extrêmement résistant à l'eau. Empire est disponible en grand format de 22,8x180 cm.

LINKFLOOR flooring by L'Antic Colonial consists of different layers depending on the model.
 Los pavimentos LINKFLOOR de L'Antic Colonial se componen de diferentes capas dependiendo del modelo.
 Les revêtements de sol LINKFLOOR de L'Antic Colonial sont composés de différentes couches en fonction du modèle.

CONTRACT

- C1. Vinyl fabric consisting of a vinyl compact encapsulated polyester core. 1mm.
Tejido de vinilo compuesto por un núcleo de poliéster encapsulado en un compacto de vinilo. 1mm.
Tissu en vinyle composé d'un noyau en polyester entouré d'une enveloppe en vinyle. 1 mm.
- C2. Rigid PVC. 4mm.
PVC Rígido. 4mm.
PVC Rigide. 4 mm.

LOOSE LAY CONTRACT

- C1. Vinyl fabric consisting of a vinyl compact encapsulated polyester core. 1,3 mm.
Tejido de vinilo compuesto por un núcleo de poliéster encapsulado en un compacto de vinilo. 1,3 mm.
Tissu en vinyle composé d'un noyau en polyester entouré d'une enveloppe en vinyle. 1,3 mm.
- C2. PVC vinyl with polyester and fiberglass internally. 2,9 mm.
Soposte vinílico de PVC con interior de poliéster y fibra de vidrio. 2,9 mm.
Support vinylique en PVC avec intérieur en polyester et fibre de verre. 2,9 mm.

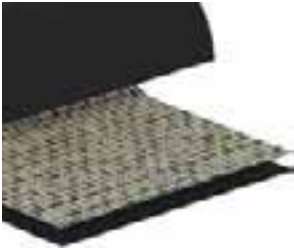
ROLL CONTRACT

- C1. Vinyl fabric consisting of a vinyl compact encapsulated polyester core. 1,8 mm.
Tejido de vinilo compuesto por un núcleo de poliéster encapsulado en un compacto de vinilo. 1,8 mm.
Tissu en vinyle composé d'un noyau en polyester entouré d'une enveloppe en vinyle. 1,8 mm.
- C2. PVC vinyl with polyester and fiberglass internally. 0,7 mm.
Soposte vinílico de PVC con interior de poliéster y fibra de vidrio. 0,7 mm.
Support vinylique en PVC avec intérieur en polyester et fibre de verre. 0,7 mm.

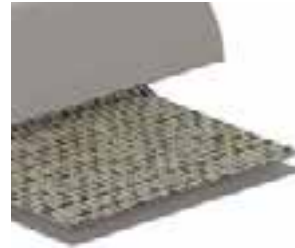
WALL CONTRACT

- C1. Vinyl 90% PVC FR, 2% Polyester, 8% Glassfibery. 1,3 mm.
Vinilo 90 % PVC FR, 2 % Poliéster, 8% Fibra de vidrio. 1,3 mm.
Vinyle 90 % PVC FR, 2 % Polyester, 8% Fibre de verre. 1,3 mm.
- C2. Polyester Backing: 100% Polyester. 0,4 mm.
Base de poliéster: 100 % Poliéster. 0,4 mm
Base en polyester : 100 % polyester. 0,4 mm.

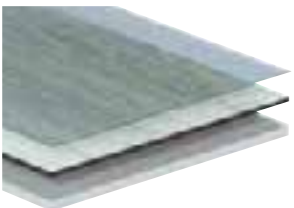
OAK

- C1. Vinyl protected with polyurethane. 0,2 mm.
Vinilo protegido con poliuretano. 0,2 mm.
Vinyle protégé par du polyuréthane. 0,2 mm.
- C2. Decoration plus vinyl. 2 mm.
Decoración más vinilo. 2 mm.
Décoration plus vinyle. 2 mm.
- C3. Rigid PVC. 3,5 mm.
PVC Rígido. 3,5 mm.
PVC Rigide. 3,5 mm.

HOTEL AIR

- C1. 0,3-0,55 mm decorative vinyl layer.
Capa decorativa vinílica de 0,3-0,55 mm.
Couche décorative vinylique de 0,3-0,55mm.
- C2. PVC and vinyl base panel. 4,4-4,7 mm.
Placa base de PVC con fibra de vidrio. 4,4-4,7 mm.
Plaque de base en PVC et bre de verre. 4,4-4,7 mm.

EMPIRE

- C1. 1,5mm LVT
- C2. 4,5mm WPC
- C3. 1,5mm EVA

Installation Systems / Sistemas de Instalación / Système de Pose



1. Tip
Inclinar
Inclinaison



2. Fit Together
Encajar
Emboîtement



3. Press Into Place
Presionar
Compression



4. Ready
Listo
Et Voilà

One of the main features of this easy-to-install system is the long-lasting secure locking mechanism, ensuring that no gaps appear between the boards during the floor's useful life. Pressure is exerted on the boards when fitted, locking them securely into place and preventing them from being wrongly aligned.

La seguridad y la durabilidad de unión entre juntas son las principales características de este sistema de fácil instalación que garantiza la eliminación de las rendijas entre las laminas durante toda la vida útil del suelo. La presión que se ejerce entre las laminas refuerza la unión e impide que ésta no se realice de forma incorrecta.

La sécurité et la durabilité du raccord entre les planches constituent les principales caractéristiques de ce système facile à poser qui garantit l'élimination de fentes entre les planches tout au long de la vie utile du revêtement de sol. La pression exercée entre les planches renforce leur assemblage et empêche toute erreur de pose.

Formats / Formatos / Formats

Roll Contract 200x1000cm - 78 3/4"x393 3/4"
(Roll / Rollo / Roleau)

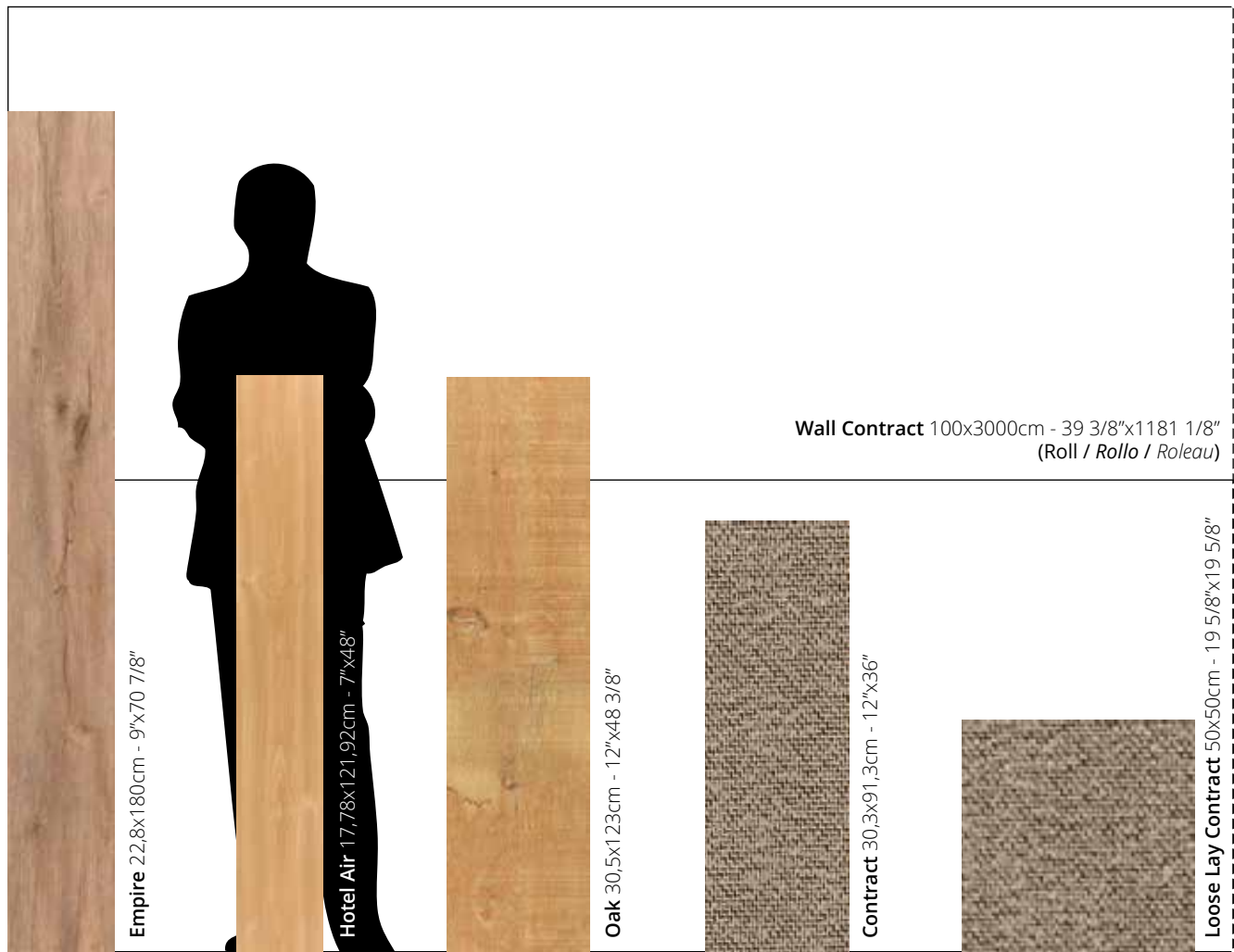

Wall Contract 100x3000cm - 39 3/8"x1181 1/8"
(Roll / Rollo / Roleau)

08 Description of Finishes / Descripción Acabados / Description Finitions



LIFE

Laminate with texture similar to brushed wood.
Laminado con textura similar a la madera cepillada.
Stratifié dont la texture est semblable à celle du bois brossé.



NATURAL

Floor that imitates the surface of the wood.
NATURAL
Suelo que imita la superficie de la madera.
NATUREL
Sol qui imite la surface du bois.

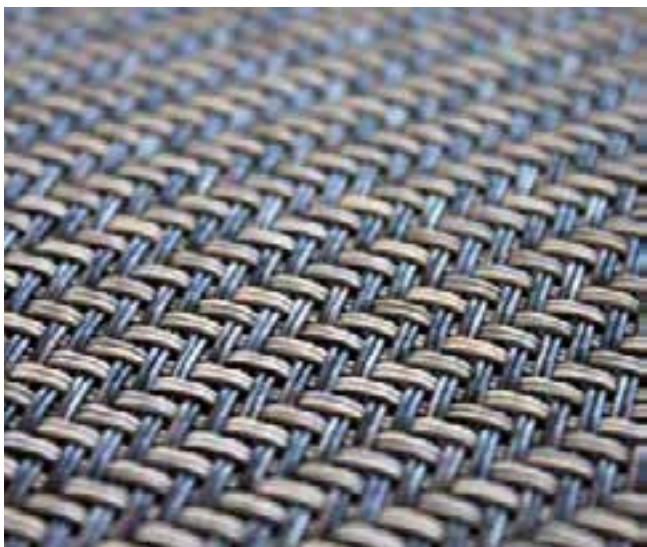

TEXTILE

Weaved material.
TEXTIL
Material trenzado.
TEXTILE
Matériau tressé.



WET

Water and moisture resistant flooring suitable for humid areas such as bathrooms and kitchens.
Suelo resistente al agua y a la humedad, apto para zonas húmedas como baños y cocinas.
Plancher résistant à l'eau et l'humidité, convient aux zones humides telles que les salles de bain et cuisines.

Key To Symbols / Descripción de Iconos / Description des Symboles



FLOATING INSTALLATION

Installation system in which it is not necessary to glue the pieces to the floor. Removal is much more dynamic, making repairs easier and making it the ideal system for refurbishments.

INSTALACIÓN FLOTANTE

Sistema de instalación en el que no es necesario encolar las piezas al suelo.

La desinstalación es mucho más dinámica facilitando las reparaciones y convirtiéndolo en el sistema ideal para reformas.

SYSTÈME FLOTTANT

Système d'installation où il n'est pas nécessaire de coller les pièces au sol. Le démontage est beaucoup plus dynamique et facilite les réparations, ce qui en fait un système idéal pour les travaux de rénovation.



15 YEAR WARRANTY

Quality product, made with selected raw materials, guaranteeing its full performance in residential use for 15 years.

GARANTÍA 15 AÑOS

Producto de calidad, realizado con materias primas seleccionadas, garantizando su uso pleno en vivienda por 15 años.

GARANTIE 15 ANS

Produit de qualité élaboré avec des matières premières de choix, avec une garantie de 15 ans d'utilisation en logement.



SUITABLE RADIANT WATER FLOOR HEATING

Suitable for installing on radiant water floor heating.

APTO CALEFACCIÓN RADIANTE POR AGUA

Apto para su instalación sobre calefacción radiante por agua.

ADAPTÉ À UN PLANCHER CHAUFFANT À EAU

Adapté à une installation sur un sol chauffant à l'eau.



ANTI-STATIC FLOOR

Floor capable of dissipating excess electrical charges and spread them over the entire surface.

SUELO ANTIESTÁTICO

Suelo capaz de disipar los excesos de cargas eléctricas y repartirlos por toda la superficie.

SOL ANTISTATIQUE

Sol en mesure de dissiper les excès de charges électriques et de les répartir sur toute la surface.



ROLL

Roll format.

ROLLO

Formato en rollo

ROLEAU

Format en rouleau



GLUING

Required apply adhesive for installation.

ENCOLADO

Es necesario aplicar adhesivo para su instalación.

COLLAGE

Il faut appliquer adhésif pour l'installation.



SLIGHT COLOR VARIATION

There are slight color changes between pieces.

VARIACIÓN DE TONO LIGERA

Existen cambios de color suaves entre piezas.

LÉGÈRE VARIATION DE TONALITÉ
Il existe de légers changements de couleur entre les pièces.



MODERATE COLOR VARIATION

There are consistent color changes between pieces.

VARIACIÓN DE TONO MODERADA

Existen cambios de color regulares entre piezas.

VARIATION DE TONALITÉ MODÉRÉE
Il existe des changements de couleur réguliers entre les pièces.



STRONG COLOR VARIATION

There are noticeable color changes between pieces.

VARIACIÓN DE TONO FUERTE

Existen cambios de color importantes entre piezas.

FORTE VARIATION DE TONALITÉ
Il existe d'importants changements de couleur entre les pièces.



Contract

—
Graphite
Steel
Diamond
Titanium
Zinc
Sand
Cotton
Gravel
Clay

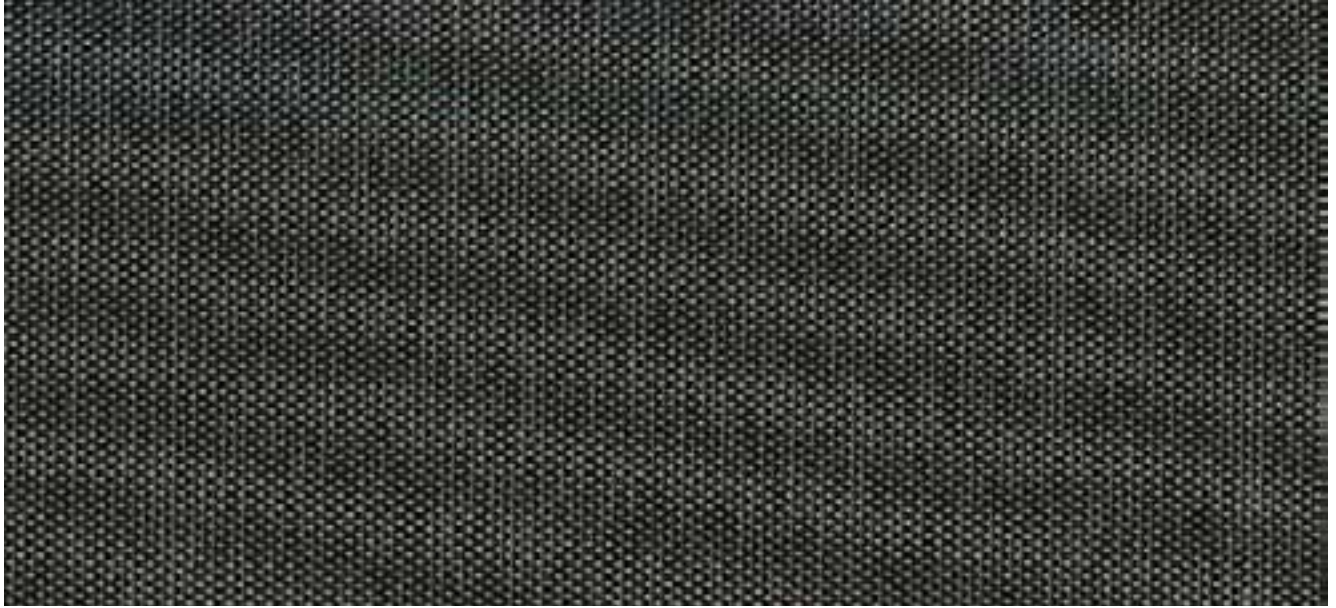

Linkfloor Contract Graphite



TEXTILE



WET

FLOATING
INSTALLATIONRADIANT
FLOOR
HEATING

LOCK



WARRANTY

ANTI-STATIC
FLOORMODERATE
COLOR
VARIATION

Description	Format	Codes	Group	Pcs	m2	Kg
Linkfloor Contract Graphite	30,3x91,3x0,57cm 12"x36"x1/4"	100126709 L167012126	G-252	7 x Cj 420 x Pal	1,93 x Cj 116,18 x Pal	15,42 x Cj 925,26 x Pal
Aluminium Skirting / Zócalo Aluminio / Plinthe Aluminium	8x225cm 3 1/8"x88 5/8"	100128267 L167901793	G-121	12 x Cj 696 x Pal	2,16 x Cj 125,28 x Pal	19,45 x Cj 1128,22 x Pal
Aluminium Linkfloor Adh Profile / Perfil Adh Linkfloor Aluminio / Profilé Adh Linkfloor Aluminium	3,5x270cm 1 3/8"x106 1/4"	100174756 L167012669	G-121	10 x Cj 1000 x Pal	0,95 x Cj 94,50 x Pal	3,87 x Cj 387 x Pal

*The ADH Aluminium Profile may be used as a transition or levelling profile.
El Perfil ADH Aluminio se puede utilizar como perfil de transición e igualación.
Le profilé ADH aluminium peut être utilisé comme profilé de transition ou d'égalisation.



Linkfloor Contract Steel



TEXTILE



WET

FLOATING
INSTALLATIONRADIANT
FLOOR
HEATING

LOCK



WARRANTY

ANTI-STATIC
FLOORMODERATE
COLOR
VARIATION

Description	Format	Codes	Group	Pcs	m2	Kg
Linkfloor Contract Steel	30,3x91,3x0,57cm 12"x36"x1/4"	100126713 L167012135	G-252	7 x Cj 420 x Pal	1,93 x Cj 116,18 x Pal	15,42 x Cj 925,26 x Pal
Aluminium Skirting / Zócalo Aluminio / Plinthe Aluminium	8x225cm 3 1/8"x88 5/8"	100128267 L167901793	G-121	12 x Cj 696 x Pal	2,16 x Cj 125,28 x Pal	19,45 x Cj 1128,22 x Pal
Aluminium Linkfloor Adh Profile / Perfil Adh Linkfloor Aluminio / Profilé Adh Linkfloor Aluminium	3,5x270cm 1 3/8"x106 1/4"	100174756 L167012669	G-121	10 x Cj 1000 x Pal	0,95 x Cj 94,50 x Pal	3,87 x Cj 387 x Pal

*The ADH Aluminium Profile may be used as a transition or levelling profile.
El Perfil ADH Aluminio se puede utilizar como perfil de transición e igualación.
Le profilé ADH aluminium peut être utilisé comme profilé de transition ou d'égalisation.

Contract

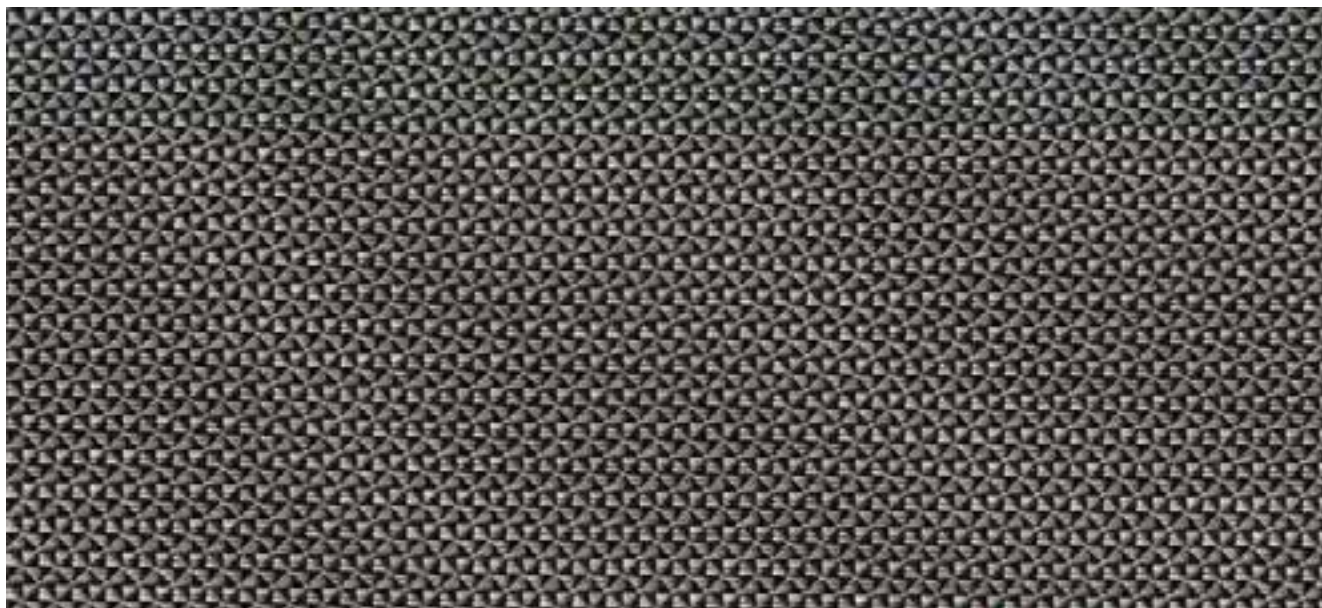

Linkfloor Contract Diamond



TEXTILE



WET



FLOATING
INSTALLATION



RADIANT
FLOOR
HEATING



LOCK



WARRANTY



ANTI-STATIC
FLOOR



MODERATE
COLOR
VARIATION

Description	Format	Codes	Group	Pcs	m2	Kg
Linkfloor Contract Diamond	30,3x91,3x0,57cm 12"x36"x1/4"	100126708 L167012141	G-252	7 x Cj 420 x Pal	1,93 x Cj 116,18 x Pal	15,42 x Cj 925,26 x Pal
Aluminium Skirting / Zócalo Aluminio / Plinthe Aluminium	8x225cm 3 1/8"x88 5/8"	100128267 L167901793	G-121	12 x Cj 696 x Pal	2,16 x Cj 125,28 x Pal	19,45 x Cj 1128,22 x Pal
Aluminium Linkfloor Adh Profile / Perfil Adh Linkfloor Aluminio / Profilé Adh Linkfloor Aluminium	3,5x270cm 1 3/8"x106 1/4"	100174756 L167012669	G-121	10 x Cj 1000 x Pal	0,95 x Cj 94,50 x Pal	3,87 x Cj 387 x Pal

*The ADH Aluminium Profile may be used as a transition or levelling profile.
El Perfil ADH Aluminio se puede utilizar como perfil de transición e igualación.
Le profilé ADH aluminium peut être utilisé comme profilé de transition ou d'égalisation.



Linkfloor Contract Titanium



TEXTILE



WET



FLOATING
INSTALLATION



RADIANT
FLOOR
HEATING



LOCK



WARRANTY



ANTI-STATIC
FLOOR



MODERATE
COLOR
VARIATION

Description	Format	Codes	Group	Pcs	m2	Kg
Linkfloor Contract Titanium	30,3x91,3x0,57cm 12"x36"x1/4"	100161236 L167012570	G-252	7 x Cj 420 x Pal	1,95 x Cj 117,21 x Pal	16,67 x Cj 1000,44 x Pal
Aluminium Skirting / Zócalo Aluminio / Plinthe Aluminium	8x225cm 3 1/8"x88 5/8"	100128267 L167901793	G-121	12 x Cj 696 x Pal	2,16 x Cj 125,28 x Pal	19,45 x Cj 1128,22 x Pal
Aluminium Linkfloor Adh Profile / Perfil Adh Linkfloor Aluminio / Profilé Adh Linkfloor Aluminium	3,5x270cm 1 3/8"x106 1/4"	100174756 L167012669	G-121	10 x Cj 1000 x Pal	0,95 x Cj 94,50 x Pal	3,87 x Cj 387 x Pal

*The ADH Aluminium Profile may be used as a transition or levelling profile.
El Perfil ADH Aluminio se puede utilizar como perfil de transición e igualación.
Le profilé ADH aluminium peut être utilisé comme profilé de transition ou d'égalisation.

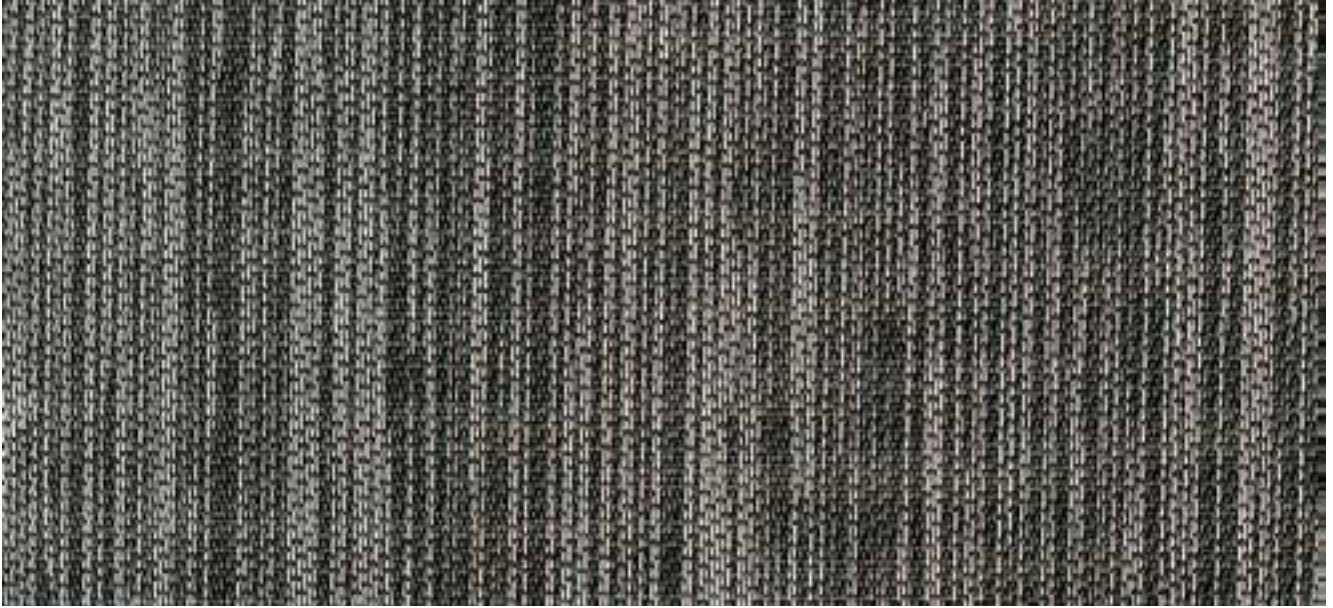

**Linkfloor
Contract Zinc**



Description	Format	Codes	Group	Pcs	m2	Kg
Linkfloor Contract Zinc	30,3x91,3x0,57cm 12"x36"x1/4"	100161138 L167012569	G-252	7 x Cj 420 x Pal	1,95 x Cj 117,21 x Pal	16,67 x Cj 1000,44 x Pal
Aluminium Skirting / Zócalo Aluminio / Plinthe Aluminium	8x225cm 3 1/8"x88 5/8"	100128267 L167901793	G-121	12 x Cj 696 x Pal	2,16 x Cj 125,28 x Pal	19,45 x Cj 1128,22 x Pal
Aluminium Linkfloor Adh Profile / Perfil Adh Linkfloor Aluminio / Profilé Adh Linkfloor Aluminium	3,5x270cm 1 3/8"x106 1/4"	100174756 L167012669	G-121	10 x Cj 1000 x Pal	0,95 x Cj 94,50 x Pal	3,87 x Cj 387 x Pal

*The ADH Aluminium Profile may be used as a transition or levelling profile.
 El Perfil ADH Aluminio se puede utilizar como perfil de transición e igualación.
 Le profilé ADH aluminium peut être utilisé comme profilé de transition ou d'égalisation.



**Linkfloor Contract
Sand**



Description	Format	Codes	Group	Pcs	m2	Kg
Linkfloor Contract Sand	30,3x91,3x0,57cm 12"x36"x1/4"	100126712 L167012139	G-252	7 x Cj 420 x Pal	1,93 x Cj 116,18 x Pal	15,42 x Cj 925,26 x Pal
Aluminium Skirting / Zócalo Aluminio / Plinthe Aluminium	8x225cm 3 1/8"x88 5/8"	100128267 L167901793	G-121	12 x Cj 696 x Pal	2,16 x Cj 125,28 x Pal	19,45 x Cj 1128,22 x Pal
Aluminium Linkfloor Adh Profile / Perfil Adh Linkfloor Aluminio / Profilé Adh Linkfloor Aluminium	3,5x270cm 1 3/8"x106 1/4"	100174756 L167012669	G-121	10 x Cj 1000 x Pal	0,95 x Cj 94,50 x Pal	3,87 x Cj 387 x Pal

*The ADH Aluminium Profile may be used as a transition or levelling profile.
 El Perfil ADH Aluminio se puede utilizar como perfil de transición e igualación.
 Le profilé ADH aluminium peut être utilisé comme profilé de transition ou d'égalisation.

Contract



Linkfloor Contract Cotton



TEXTILE



WET



FLOATING
INSTALLATION



RADIANT
FLOOR
HEATING



LOCK



WARRANTY



ANTI-STATIC
FLOOR



MODERATE
COLOR
VARIATION

Description	Format	Codes	Group	Pcs	m2	Kg
Linkfloor Contract Cotton	30,3x91,3x0,57cm 12"x36"x1/4"	100126707 L167012128	G-252	7 x Cj 420 x Pal	1,93 x Cj 116,18 x Pal	15,42 x Cj 925,26 x Pal
Aluminium Skirting / Zócalo Aluminio / Plinthe Aluminium	8x225cm 3 1/8"x88 5/8"	100128267 L167901793	G-121	12 x Cj 696 x Pal	2,16 x Cj 125,28 x Pal	19,45 x Cj 1128,22 x Pal
Aluminium Linkfloor Adh Profile / Perfil Adh Linkfloor Aluminio / Profilé Adh Linkfloor Aluminium	3,5x270cm 1 3/8"x106 1/4"	100174756 L167012669	G-121	10 x Cj 1000 x Pal	0,95 x Cj 94,50 x Pal	3,87 x Cj 387 x Pal

*The ADH Aluminium Profile may be used as a transition or levelling profile.
El Perfil ADH Aluminio se puede utilizar como perfil de transición e igualación.
Le profilé ADH aluminium peut être utilisé comme profilé de transition ou d'égalisation.



Linkfloor Contract Gravel



TEXTILE



WET



FLOATING
INSTALLATION



RADIANT
FLOOR
HEATING



LOCK



WARRANTY



ANTI-STATIC
FLOOR



MODERATE
COLOR
VARIATION

Description	Format	Codes	Group	Pcs	m2	Kg
Linkfloor Contract Gravel	30,3x91,3x0,57cm 12"x36"x1/4"	100126710 L167012129	G-252	7 x Cj 420 x Pal	1,93 x Cj 116,18 x Pal	15,42 x Cj 925,26 x Pal
Aluminium Skirting / Zócalo Aluminio / Plinthe Aluminium	8x225cm 3 1/8"x88 5/8"	100128267 L167901793	G-121	12 x Cj 696 x Pal	2,16 x Cj 125,28 x Pal	19,45 x Cj 1128,22 x Pal
Aluminium Linkfloor Adh Profile / Perfil Adh Linkfloor Aluminio / Profilé Adh Linkfloor Aluminium	3,5x270cm 1 3/8"x106 1/4"	100174756 L167012669	G-121	10 x Cj 1000 x Pal	0,95 x Cj 94,50 x Pal	3,87 x Cj 387 x Pal

*The ADH Aluminium Profile may be used as a transition or levelling profile.
El Perfil ADH Aluminio se puede utilizar como perfil de transición e igualación.
Le profilé ADH aluminium peut être utilisé comme profilé de transition ou d'égalisation.



Linkfloor Contract Clay



Description	Format	Codes	Group	Pcs	m2	Kg
Linkfloor Contract Clay	30,3x91,3x0,57cm 12"x36"x1/4"	100126706 L167012131	G-252	7 x Cj 420 x Pal	1,93 x Cj 116,18 x Pal	15,42 x Cj 925,26 x Pal
Aluminium Skirting / Zócalo Aluminio / Plinthe Aluminium	8x225cm 3 1/8"x88 5/8"	100128267 L167901793	G-121	12 x Cj 696 x Pal	2,16 x Cj 125,28 x Pal	19,45 x Cj 1128,22 x Pal
Aluminium Linkfloor Adh Profile / Perfil Adh Linkfloor Aluminio / Profilé Adh Linkfloor Aluminium	3,5x270cm 1 3/8"x106 1/4"	100174756 L167012669	G-121	10 x Cj 1000 x Pal	0,95 x Cj 94,50 x Pal	3,87 x Cj 387 x Pal

*The ADH Aluminium Profile may be used as a transition or levelling profile.
 El Perfil ADH Aluminio se puede utilizar como perfil de transición e igualación.
 Le profilé ADH aluminium peut être utilisé comme profilé de transition ou d'égalisation.



Floor Coverings Linkfloor Contract Clay / Wall Coverings Wood Feel



807

808

81
81

BEFORE INSTALLING

ANTES DE LA INSTALACIÓN

AVANT DE COMMENCER LA POSE

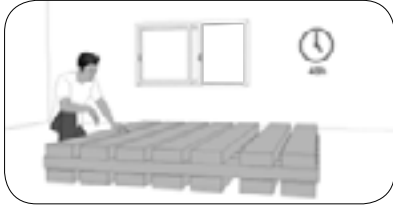

The material must be climatized to the temperature of the setting where it will be installed for 48h beforehand.

Material acondicionado a temperatura del entorno donde se va a instalar durante las 48h previas.

Matériel aménagé à la température de l'endroit où il sera installé au cours des 48h préalables.



Optimal conditions: Temp. 20-23°C/65-80°F and 40-60% relative humidity.

Condiciones óptimas 20-23°C/65-80°F y 40-60% de humedad.

Conditions optimales : 20-23°C/65-80°F et 40-60% d'humidité.



Open several packages and mix pieces before installing.

Abrir varios paquetes y mezclar piezas antes de la instalación.

Ouvrir les paquets et mélanger les pièces avant l'installation.



Dry and moisture-free, compact and resistant, clean and dust-free surface.

Superficie seca y sin humedad, compacta y resistente, limpia y sin polvo.

La surface doit être sèche et sans humidité, compacte et résistante, propre et sans poussière.

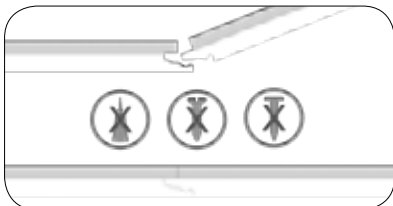

Do not set the anchors with nails, screws, or glues.

No fijar los anclajes con clavos, tornillos o colas.

Ne pas fixer les ancrages avec des clous, des vis ou de la colle.

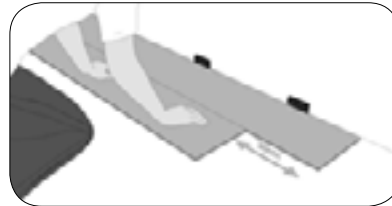

Stagger from the joint, no less than 30cm between pieces.

Escalonar desde la junta, distancias no inferiores de 30cm entre piezas.

Échelonner à partir du joint, la distance entre les pièces ne doit pas être inférieure à 30cm.

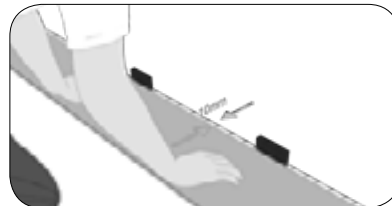

Keep a distance of 1 cm to all structural elements from all perimeter edges (in the case of semi-open spaces leave a larger perimeter separation, 0.5mm per linear meter of the area where the floor is being installed.)

Expansion joints in all the door thresholds and mandatorily every 8m lengthwise and/or cross-wise.

Mantener distancia de 1cm a todos los elementos estructurales desde todos los bordes del perímetro (en espacios semiabiertos dejar mayor separación perimetral: 0,5mm por metro lineal de la zona donde se instale el suelo).

Juntas de dilatación en todos los pasos de puerta y obligatoriamente cada 8m en sentido longitudinal y/o transversal.

Conserver une distance de 1 cm de tous les éléments structurels depuis tous les bords du périmètre (dans des espaces semi-ouverts, laisser une séparation périmétrale plus grande: 0,5mm par mètre linéaire de la zone où le revêtement sera mis en place).

Joints de dilatation sur tous les passages de porte et obligatoirement tous les 8m en sens longitudinal et/ou transversal.

INSTALLATION

INSTALACIÓN

POSE

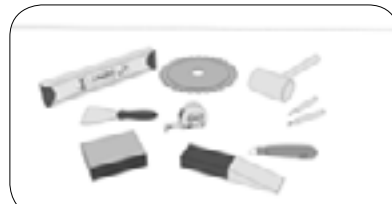

Tools: tape measure, pencil, saw, hammer, sealant, level, spacer wedges, and if possible, a padfoot, and a nylon stud.

Herramientas: cinta métrica, lápiz, sierra, martillo, sellador, nivel, cuñas espaciadoras y, si es posible, una pata de cabra y taco de nylon.

Outils: mètre, crayon, scie, marteau, appareil à souder, niveau, cales et, si c'est possible, pied de biche et cheville en nylon.



We recommend installing the L'Antic Colonial sheet, whether it is the moisture barrier+foam sheet or the antistatic radiant-floor film.

Se recomienda la instalación de la lámina de L' Antic Colonial. Ya sea la lámina anti-humedad+espuma o la de suelo radiante antiestática.

Il est recommandé d'installer la lame de L'Antic Colonial. Soit la lame anti-humidité+mousse, soit la lame de plancher rayonnant anti-statique.

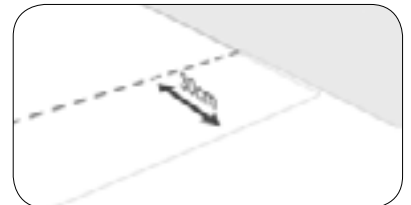

Overlap the film about 30cm.

Solapar el film unos 30cm.

Chevaucher le film environ 30cm.



Always install the material floating, without glue below the surface.

Colocar el material de manera flotante, sin pegamento debajo de la superficie.

Poser le matériel en flottaison et sans colle sous la surface.



Positioned the pieces longitudinally with respect to the light entrance whenever possible.

Posicionar las piezas longitudinalmente respecto a la entrada de luz, siempre que sea posible.

Placer les pièces longitudinalement par rapport à l'entrée de lumière, lorsque cela est possible.

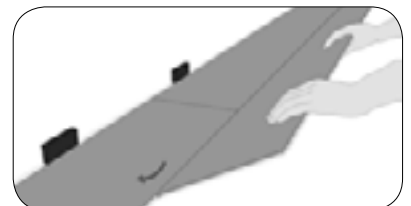

After having aligned the first row with the help of a level, install the second one using the left-over piece.

Tras haber alineado la primera fila con

Installation / Instalación / Installation

la ayuda de un nivel, colocar la segunda, usando la pieza sobrante.

Après avoir aligné la première file à l'aide d'un niveau, placer la deuxième en utilisant la pièce en trop.

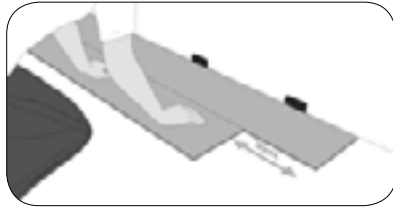

The piece joints between 2 rows shall be at least about 30cm apart.

Las juntas de las piezas entre 2 filas deben distar unos 30cm como mínimo.

Les joints des pièces entre deux files doivent être à une distance minimale de 30cm.

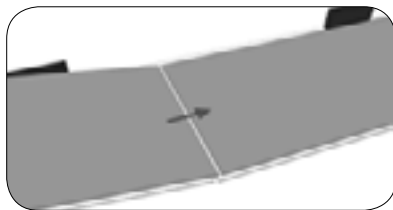

Install the first piece slightly diagonally, tighten, and gently swing. Proceed the same way with the second board, and position the head in front of the previous piece.

Instalar la primera pieza ligeramente en diagonal, apretar y balancear suavemente. Proceder de la misma forma con la segunda tabla, y posicionar la cabeza en frente de la pieza anterior.

Installer la première pièce légèrement en diagonale, serrer puis balancer doucement. Installer la deuxième planche de la même manière et placer la tête face à la pièce précédente.

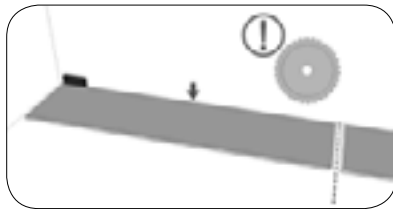

Cut the piece needed to complete the first row of the shortest wall of the room where it is being installed.

Cortar la pieza, necesaria para completar la primera fila, en la pared más corta de la habitación.

Couper la pièce, nécessaire pour compléter la première file, sur la cloison plus courte de la chambre.

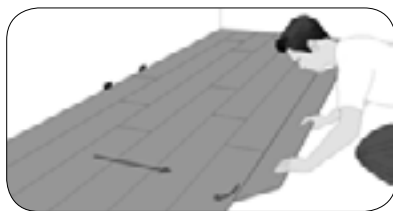

Join the pieces laterally with a 45° movement, until you feel the closing click, aligning with the wedges from the wall. The distance to the wall shall be at least 1cm.

Juntar las piezas lateralmente con un movimiento de 45°, hasta notar el cierre del clic, alineando con las cuñas desde la pared.

Distancia hasta la pared de 1cm como mínimo.

Unir las piezas lateralmente con un movimiento de 45°, jusqu'à entendre la fermeture du clic, en les alignant avec les cales à partir du mur. Distance minimale jusqu'au mur: 1cm.



Remove the spacer wedges after finishing the installation.

Retirar las cuñas espaciadoras después de completar la instalación.

Enlever les cales après la mise en place de l'installation.

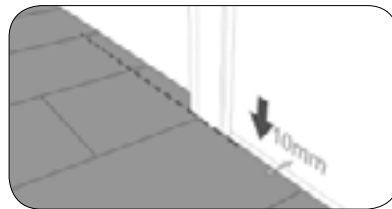

Cut the doors moldings at floor height, and when installing the plank that goes under the moldings, measure the distance to the wall and give it at least 10mm of space.

Cortar las tapetas de las puertas, a la altura del suelo, y al instalar la tabla que va bajo las tapetas, medir la distancia hasta la pared y darle los 10mm mínimos de espacio.

Couper les couvre-joints des portes, à la hauteur du sol. Lors de l'installation de la planche qui va sous les couvre-joints, mesurer la distance jusqu'au mur et ajouter les 10mm minimaux d'espace.



Place a rug under tables and chairs... In case of heavy furniture, do not drag them directly on the installed floor.

Poner una alfombra bajo las mesas y sillas, etc... En caso de posicionar muebles pesados, no arrastarlos directamente sobre el suelo instalado.

Mettre un tapis sous les tables et les chaises, etc. S'il faut placer des meubles lourds, ne pas les déplacer directement sur le plancher posé.

RADIANT FLOOR HEATING
CALEFACCIÓN RADIANTE
CHAUFFAGE RADIANT



Activate to 25-30°C during the 10 days

prior to the installation. We recommend installing the L'Antic Colonial antistatic radiant-floor film.

Activar a 25-30°C durante los 10 días previos a la instalación. Recomendamos colocar la Lámina para Suelo Radiante Antiestática de L'Antic Colonial.

Activer la température à 25-30°C pendant les dix jours préalables à la pose. Il est recommandé d'installer la lame pour plancher rayonnant anti-statique de L'Antic Colonial.



After installing turn the heating on gradually, increasing the temperature by 2-3°C each day, up to about 28°C.

Tras las instalación, encender la calefacción gradualmente, incrementando la temperatura 2-3°C cada día, hasta unos 28°C.

Après la pose, allumer le chauffage graduellement, en augmentant la température entre 2 et 3°C chaque jour jusqu'à atteindre environ 28°C.



Keep at least one day per cm of thickness of the sub-base, and keep overnight.

Mantener como mínimo un día por cada cm de espesor del subsuelo, y mantener durante toda la noche.

Maintenir la température au moins un jour pour chaque centimètre d'épaisseur du sous-sol pendant toute la nuit.



Next, the temperature must be lowered 2-3°C daily until the floor reaches 15°C (about 10 days.)

A continuación, disminuir la temperatura 2-3°C diarios hasta que el suelo alcance los 15°C (unos 10 días).

Ensuite, diminuer la température entre 2 et 3°C jusqu'à ce que la température du sol arrive à 15°C (environ 10 jours).

You can see these updated installation instructions by visiting our website www.anticcolonial.com

Puedes revisar estas instrucciones de instalación actualizadas y con más detalle visitando nuestra página web www.anticcolonial.com

Pour réviser ces instructions d'installation, mises à jour et plus détaillées, veuillez visiter notre site Internet www.anticcolonial.com

Roll Contract

—
Graphite
Diamond
Titanium
Zinc
Sand
Cotton
Gravel
Clay
Steel



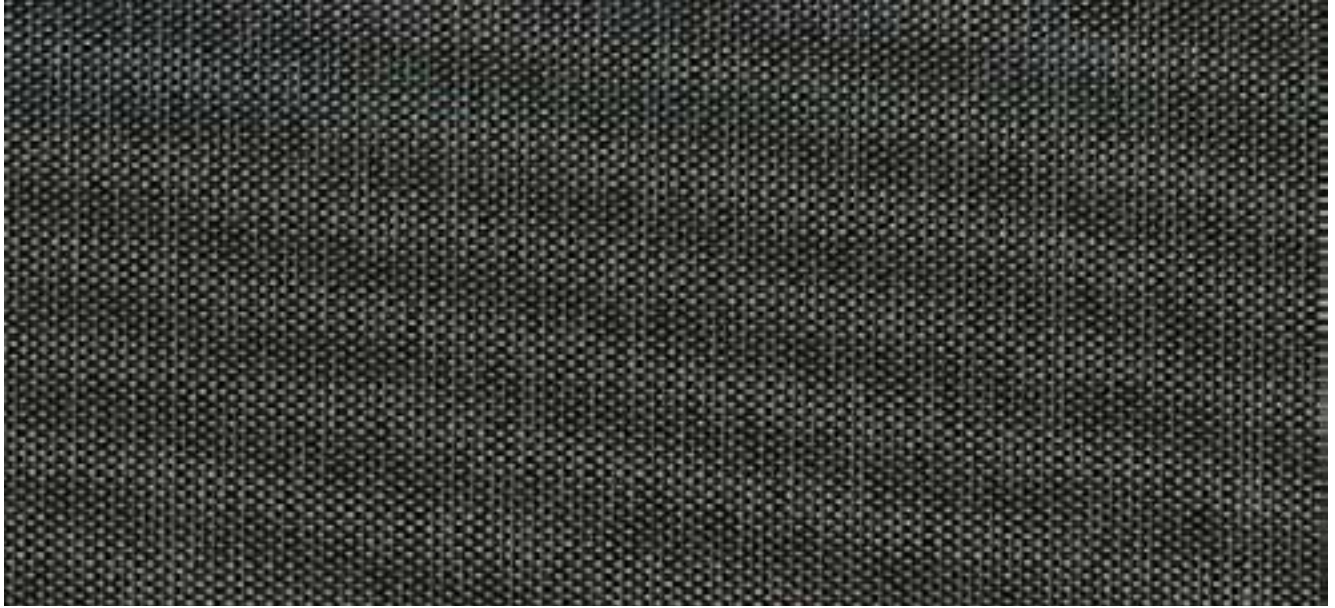

Linkfloor Roll Contract Graphite



TEXTILE



ROLL



WET

RADIANT
FLOOR
HEATING

GLUING



WARRANTY

ANTI-STATIC
FLOORMODERATE
COLOR
VARIATION

Description	Format	Codes	Group	Pcs	m2	Kg
Linkfloor Roll Contract Graphite	200x1000x0,25cm 78 3/4"x393 3/4"x1/8"	100161360 L167012574	G-232	1 x Cj 16 x Pal	20 x Cj 320 x Pal	70 x Cj 1120 x Pal
Aluminium Skirting / Zócalo Aluminio / Plinthe Aluminium	8x225cm 3 1/8"x88 5/8"	100128267 L167901793	G-121	12 x Cj 696 x Pal	2,16 x Cj 125,28 x Pal	19,45 x Cj 1128,22 x Pal
Aluminium Linkfloor Adh Profile / Perfil Adh Linkfloor Aluminio / Profilé Adh Linkfloor Aluminium	3,5x270cm 1 3/8"x106 1/4"	100174756 L167012669	G-121	10 x Cj 1000 x Pal	0,95 x Cj 94,50 x Pal	3,87 x Cj 387 x Pal
Silver Staircase Step Finish / Terminación Peldaño Escalera Plata / Finition Marche Escalier Argentée	200cm 78 3/4"	100222706 L167012941	G-126	10 x Cj 1000 x Pal	10 x Cj 1000 x Pal	5,17 x Cj 517 x Pal
Black Staircase Step Finish / Terminación Peldaño Escalera Negro / Finition Marche Escalier Noire	200cm 78 3/4"	100222747 L167012942	G-135	10 x Cj 1000 x Pal	10 x Cj 1000 x Pal	5,17 x Cj 517 x Pal

*The ADH Aluminium Profile may be used as a transition or leveling profile.
El Perfil ADH Aluminio se puede utilizar como perfil de transición e igualación.
Le profilé ADH aluminium peut être utilisé comme profilé de transition ou d'égalisation.

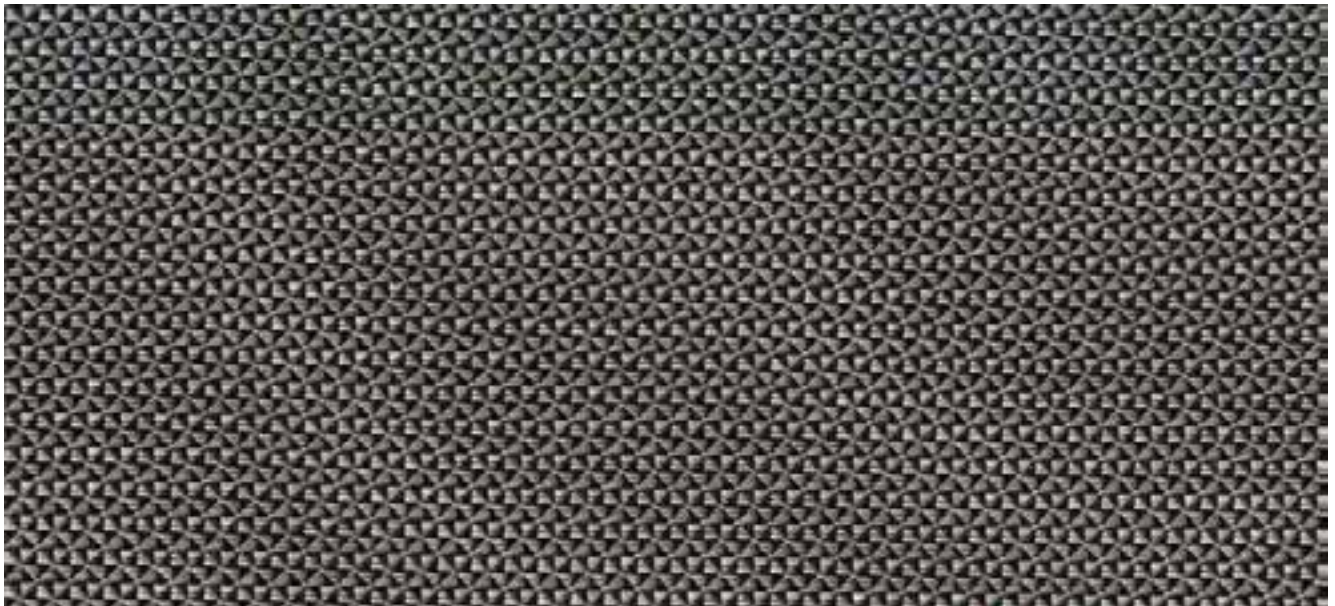

Linkfloor Roll Contract Diamond



TEXTILE



ROLL



WET

RADIANT
FLOOR
HEATING

GLUING



WARRANTY

ANTI-STATIC
FLOORMODERATE
COLOR
VARIATION

Description	Format	Codes	Group	Pcs	m2	Kg
Linkfloor Roll Contract Diamond	200x1000x0,25cm 78 3/4"x393 3/4"x1/8"	100161345 L167012573	G-232	1 x Cj 16 x Pal	20 x Cj 320 x Pal	70 x Cj 1120 x Pal
Aluminium Skirting / Zócalo Aluminio / Plinthe Aluminium	8x225cm 3 1/8"x88 5/8"	100128267 L167901793	G-121	12 x Cj 696 x Pal	2,16 x Cj 125,28 x Pal	19,45 x Cj 1128,22 x Pal
Aluminium Linkfloor Adh Profile / Perfil Adh Linkfloor Aluminio / Profilé Adh Linkfloor Aluminium	3,5x270cm 1 3/8"x106 1/4"	100174756 L167012669	G-121	10 x Cj 1000 x Pal	0,95 x Cj 94,50 x Pal	3,87 x Cj 387 x Pal
Silver Staircase Step Finish / Terminación Peldaño Escalera Plata / Finition Marche Escalier Argentée	200cm 78 3/4"	100222706 L167012941	G-126	10 x Cj 1000 x Pal	10 x Cj 1000 x Pal	5,17 x Cj 517 x Pal
Black Staircase Step Finish / Terminación Peldaño Escalera Negro / Finition Marche Escalier Noire	200cm 78 3/4"	100222747 L167012942	G-135	10 x Cj 1000 x Pal	10 x Cj 1000 x Pal	5,17 x Cj 517 x Pal

*The ADH Aluminium Profile may be used as a transition or leveling profile.
El Perfil ADH Aluminio se puede utilizar como perfil de transición e igualación.
Le profilé ADH aluminium peut être utilisé comme profilé de transition ou d'égalisation.

Roll Contract



Linkfloor Roll Contract Titanium



TEXTILE



ROLL



WET



RADIANT FLOOR HEATING



GLUING



WARRANTY



ANTI-STATIC FLOOR



MODERATE COLOR VARIATION

Description	Format	Codes	Group	Pcs	m2	Kg
Linkfloor Roll Contract Titanium	200x1000x0,25cm 78 3/4"x393 3/4"x1/8"	100161346 L167012579	G-232	1 x Cj 16 x Pal	20 x Cj 320 x Pal	70 x Cj 1120 x Pal
Aluminium Skirting / Zócalo Aluminio / Plinthe Aluminium	8x225cm 3 1/8"x88 5/8"	100128267 L167901793	G-121	12 x Cj 696 x Pal	2,16 x Cj 125,28 x Pal	19,45 x Cj 1128,22 x Pal
Aluminium Linkfloor Adh Profile / Perfil Adh Linkfloor Aluminio / Profilé Adh Linkfloor Aluminium	3,5x270cm 1 3/8"x106 1/4"	100174756 L167012669	G-121	10 x Cj 1000 x Pal	0,95 x Cj 94,50 x Pal	3,87 x Cj 387 x Pal
Silver Staircase Step Finish / Terminación Peldaño Escalera Plata / Finition Marche Escalier Argentée	200cm 78 3/4"	100222706 L167012941	G-126	10 x Cj 1000 x Pal	10 x Cj 1000 x Pal	5,17 x Cj 517 x Pal
Black Staircase Step Finish / Terminación Peldaño Escalera Negro / Finition Marche Escalier Noire	200cm 78 3/4"	100222747 L167012942	G-135	10 x Cj 1000 x Pal	10 x Cj 1000 x Pal	5,17 x Cj 517 x Pal

*The ADH Aluminium Profile may be used as a transition or levelling profile.
El Perfil ADH Aluminio se puede utilizar como perfil de transición e igualación.
Le profilé ADH aluminium peut être utilisé comme profilé de transition ou d'égalisation.



Linkfloor Roll Contract Zinc



TEXTILE



ROLL



WET



RADIANT FLOOR HEATING



GLUING



WARRANTY



ANTI-STATIC FLOOR



MODERATE COLOR VARIATION

Description	Format	Codes	Group	Pcs	m2	Kg
Linkfloor Roll Contract Zinc	200x1000x0,25cm 78 3/4"x393 3/4"x1/8"	100161361 L167012580	G-232	1 x Cj 16 x Pal	20 x Cj 320 x Pal	70 x Cj 1120 x Pal
Aluminium Skirting / Zócalo Aluminio / Plinthe Aluminium	8x225cm 3 1/8"x88 5/8"	100128267 L167901793	G-121	12 x Cj 696 x Pal	2,16 x Cj 125,28 x Pal	19,45 x Cj 1128,22 x Pal
Aluminium Linkfloor Adh Profile / Perfil Adh Linkfloor Aluminio / Profilé Adh Linkfloor Aluminium	3,5x270cm 1 3/8"x106 1/4"	100174756 L167012669	G-121	10 x Cj 1000 x Pal	0,95 x Cj 94,50 x Pal	3,87 x Cj 387 x Pal
Silver Staircase Step Finish / Terminación Peldaño Escalera Plata / Finition Marche Escalier Argentée	200cm 78 3/4"	100222706 L167012941	G-126	10 x Cj 1000 x Pal	10 x Cj 1000 x Pal	5,17 x Cj 517 x Pal
Black Staircase Step Finish / Terminación Peldaño Escalera Negro / Finition Marche Escalier Noire	200cm 78 3/4"	100222747 L167012942	G-135	10 x Cj 1000 x Pal	10 x Cj 1000 x Pal	5,17 x Cj 517 x Pal

*The ADH Aluminium Profile may be used as a transition or levelling profile.
El Perfil ADH Aluminio se puede utilizar como perfil de transición e igualación.
Le profilé ADH aluminium peut être utilisé comme profilé de transition ou d'égalisation.



Linkfloor Roll Contract Sand



Description	Format	Codes	Group	Pcs	m2	Kg
Linkfloor Roll Contract Sand	200x1000x0,25cm 78 3/4"x393 3/4"x1/8"	100161354 L167012577	G-232	1 x Cj 16 x Pal	20 x Cj 320 x Pal	70 x Cj 1120 x Pal
Aluminium Skirting / Zócalo Aluminio / Plinthe Aluminium	8x225cm 3 1/8"x88 5/8"	100128267 L167901793	G-121	12 x Cj 696 x Pal	2,16 x Cj 125,28 x Pal	19,45 x Cj 1128,22 x Pal
Aluminium Linkfloor Adh Profile / Perfil Adh Linkfloor Aluminio / Profilé Adh Linkfloor Aluminium	3,5x270cm 1 3/8"x106 1/4"	100174756 L167012669	G-121	10 x Cj 1000 x Pal	0,95 x Cj 94,50 x Pal	3,87 x Cj 387 x Pal
Silver Staircase Step Finish / Terminación Peldaño Escalera Plata / Finition Marche Escalier Argentée	200cm 78 3/4"	100222706 L167012941	G-126	10 x Cj 1000 x Pal	10 x Cj 1000 x Pal	5,17 x Cj 517 x Pal
Black Staircase Step Finish / Terminación Peldaño Escalera Negro / Finition Marche Escalier Noire	200cm 78 3/4"	100222747 L167012942	G-135	10 x Cj 1000 x Pal	10 x Cj 1000 x Pal	5,17 x Cj 517 x Pal

*The ADH Aluminium Profile may be used as a transition or leveling profile.
 El Perfil ADH Aluminio se puede utilizar como perfil de transición e igualación.
 Le profilé ADH aluminium peut être utilisé comme profilé de transition ou d'égalisation.



Linkfloor Roll Contract Cotton



Description	Format	Codes	Group	Pcs	m2	Kg
Linkfloor Roll Contract Cotton	200x1000x0,25cm 78 3/4"x393 3/4"x1/8"	100161351 L167012572	G-232	1 x Cj 16 x Pal	20 x Cj 320 x Pal	70 x Cj 1120 x Pal
Aluminium Skirting / Zócalo Aluminio / Plinthe Aluminium	8x225cm 3 1/8"x88 5/8"	100128267 L167901793	G-121	12 x Cj 696 x Pal	2,16 x Cj 125,28 x Pal	19,45 x Cj 1128,22 x Pal
Aluminium Linkfloor Adh Profile / Perfil Adh Linkfloor Aluminio / Profilé Adh Linkfloor Aluminium	3,5x270cm 1 3/8"x106 1/4"	100174756 L167012669	G-121	10 x Cj 1000 x Pal	0,95 x Cj 94,50 x Pal	3,87 x Cj 387 x Pal
Silver Staircase Step Finish / Terminación Peldaño Escalera Plata / Finition Marche Escalier Argentée	200cm 78 3/4"	100222706 L167012941	G-126	10 x Cj 1000 x Pal	10 x Cj 1000 x Pal	5,17 x Cj 517 x Pal
Black Staircase Step Finish / Terminación Peldaño Escalera Negro / Finition Marche Escalier Noire	200cm 78 3/4"	100222747 L167012942	G-135	10 x Cj 1000 x Pal	10 x Cj 1000 x Pal	5,17 x Cj 517 x Pal

STOCK

*The ADH Aluminium Profile may be used as a transition or leveling profile.
 El Perfil ADH Aluminio se puede utilizar como perfil de transición e igualación.
 Le profilé ADH aluminium peut être utilisé comme profilé de transition ou d'égalisation.

Roll Contract

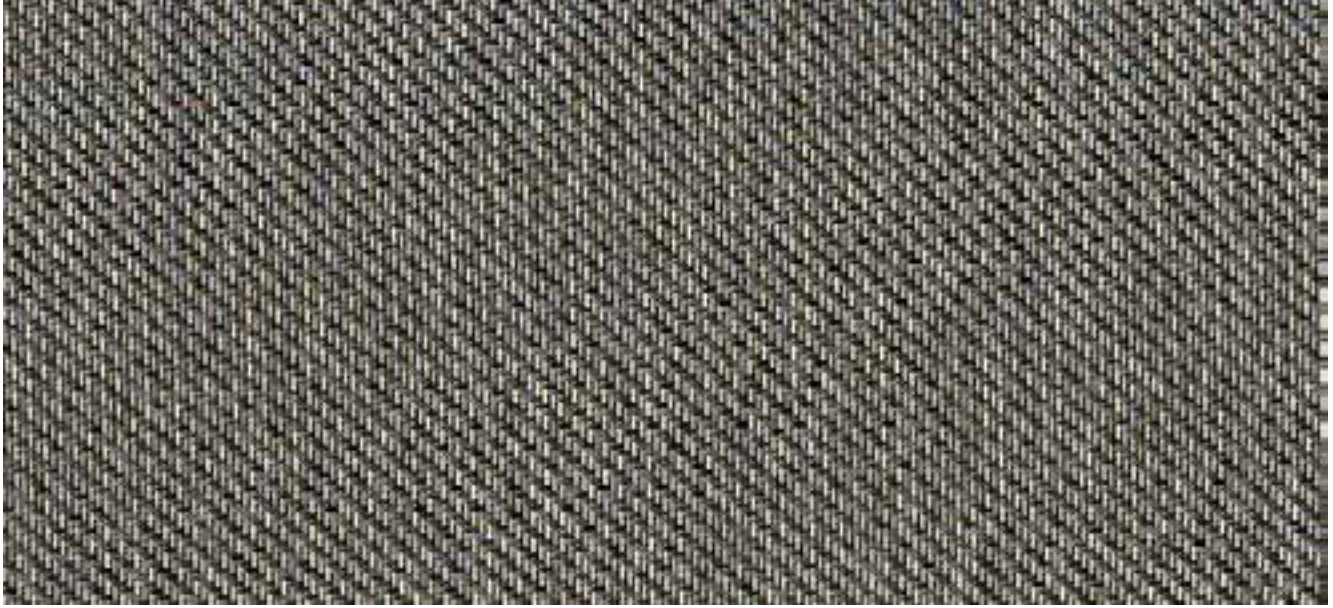

Linkfloor Roll Contract Gravel



TEXTILE



ROLL



WET



RADIANT FLOOR HEATING



GLUING



WARRANTY



ANTI-STATIC FLOOR



MODERATE COLOR VARIATION

Description	Format	Codes	Group	Pcs	m2	Kg
Linkfloor Roll Contract Gravel	200x1000x0,25cm 78 3/4"x393 3/4"x1/8"	100161352 L167012575	G-232	1 x Cj 16 x Pal	20 x Cj 320 x Pal	70 x Cj 1120 x Pal
Aluminium Skirting / Zócalo Aluminio / Plinthe Aluminium	8x225cm 3 1/8"x88 5/8"	100128267 L167901793	G-121	12 x Cj 696 x Pal	2,16 x Cj 125,28 x Pal	19,45 x Cj 1128,22 x Pal
Aluminium Linkfloor Adh Profile / Perfil Adh Linkfloor Aluminio / Profilé Adh Linkfloor Aluminium	3,5x270cm 1 3/8"x106 1/4"	100174756 L167012669	G-121	10 x Cj 1000 x Pal	0,95 x Cj 94,50 x Pal	3,87 x Cj 387 x Pal
Silver Staircase Step Finish / Terminación Peldaño Escalera Plata / Finition Marche Escalier Argentée	200cm 78 3/4"	100222706 L167012941	G-126	10 x Cj 1000 x Pal	10 x Cj 1000 x Pal	5,17 x Cj 517 x Pal
Black Staircase Step Finish / Terminación Peldaño Escalera Negro / Finition Marche Escalier Noire	200cm 78 3/4"	100222747 L167012942	G-135	10 x Cj 1000 x Pal	10 x Cj 1000 x Pal	5,17 x Cj 517 x Pal

STOCK

*The ADH Aluminium Profile may be used as a transition or levelling profile.
El Perfil ADH Aluminio se puede utilizar como perfil de transición e igualación.
Le profilé ADH aluminium peut être utilisé comme profilé de transition ou d'égalisation.



Linkfloor Roll Contract Clay



TEXTILE



ROLL



WET



RADIANT FLOOR HEATING



GLUING



WARRANTY



ANTI-STATIC FLOOR



MODERATE COLOR VARIATION

Description	Format	Codes	Group	Pcs	m2	Kg
Linkfloor Roll Contract Clay	200x1000x0,25cm 78 3/4"x393 3/4"x1/8"	100161335 L167012571	G-232	1 x Cj 16 x Pal	20 x Cj 320 x Pal	70 x Cj 1120 x Pal
Aluminium Skirting / Zócalo Aluminio / Plinthe Aluminium	8x225cm 3 1/8"x88 5/8"	100128267 L167901793	G-121	12 x Cj 696 x Pal	2,16 x Cj 125,28 x Pal	19,45 x Cj 1128,22 x Pal
Aluminium Linkfloor Adh Profile / Perfil Adh Linkfloor Aluminio / Profilé Adh Linkfloor Aluminium	3,5x270cm 1 3/8"x106 1/4"	100174756 L167012669	G-121	10 x Cj 1000 x Pal	0,95 x Cj 94,50 x Pal	3,87 x Cj 387 x Pal
Silver Staircase Step Finish / Terminación Peldaño Escalera Plata / Finition Marche Escalier Argentée	200cm 78 3/4"	100222706 L167012941	G-126	10 x Cj 1000 x Pal	10 x Cj 1000 x Pal	5,17 x Cj 517 x Pal
Black Staircase Step Finish / Terminación Peldaño Escalera Negro / Finition Marche Escalier Noire	200cm 78 3/4"	100222747 L167012942	G-135	10 x Cj 1000 x Pal	10 x Cj 1000 x Pal	5,17 x Cj 517 x Pal

*The ADH Aluminium Profile may be used as a transition or levelling profile.
El Perfil ADH Aluminio se puede utilizar como perfil de transición e igualación.
Le profilé ADH aluminium peut être utilisé comme profilé de transition ou d'égalisation.



Linkfloor Roll Contract Steel



TEXTILE



ROLL



WET

RADIANT
FLOOR
HEATING

GLUING



WARRANTY

ANTI-STATIC
FLOORMODERATE
COLOR
VARIATION

Description	Format	Codes	Group	Pcs	m2	Kg
Linkfloor Roll Contract Steel	200x1000x0,25cm 78 3/4"x393 3/4"x1/8"	100161355 L167012578	G-232	1 x Cj 16 x Pal	20 x Cj 320 x Pal	70 x Cj 1120 x Pal
Aluminium Skirting / Zócalo Aluminio / Plinthe Aluminium	8x225cm 3 1/8"x88 5/8"	100128267 L167901793	G-121	12 x Cj 696 x Pal	2,16 x Cj 125,28 x Pal	19,45 x Cj 1128,22 x Pal
Aluminium Linkfloor Adh Profile / Perfil Adh Linkfloor Aluminio / Profilé Adh Linkfloor Aluminium	3,5x270cm 1 3/8"x106 1/4"	100174756 L167012669	G-121	10 x Cj 1000 x Pal	0,95 x Cj 94,50 x Pal	3,87 x Cj 387 x Pal
Silver Staircase Step Finish / Terminación Peldaño Escalera Plata / Finition Marche Escalier Argentée	200cm 78 3/4"	100222706 L167012941	G-126	10 x Cj 1000 x Pal	10 x Cj 1000 x Pal	5,17 x Cj 517 x Pal
Black Staircase Step Finish / Terminación Peldaño Escalera Negro / Finition Marche Escalier Noire	200cm 78 3/4"	100222747 L167012942	G-135	10 x Cj 1000 x Pal	10 x Cj 1000 x Pal	5,17 x Cj 517 x Pal

*The ADH Aluminium Profile may be used as a transition or leveling profile.

El Perfil ADH Aluminio se puede utilizar como perfil de transición e igualación.

Le profilé ADH aluminium peut être utilisé comme profilé de transition ou d'égalisation.



BEFORE INSTALLING

ANTES DE INSTALAR

AVANT L'INSTALLATION

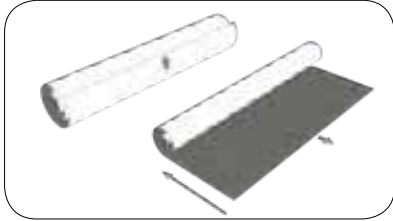

Install the product in the correct direction (arrow marked on back).

Colocar el producto en el sentido correcto (flecha marcada en parte trasera).

Poser le produit dans le sens correct (flèche marquée sur la partie arrière).



Clean, dry surface.

Superficie limpia y seca.

La surface doit être propre et sèche.

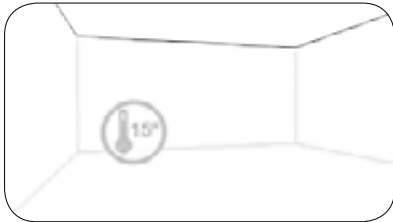

15°C maximum temperature.

Temperatura máxima de 15°C.

Température maximale: 15°C.

INSTALLING THE ROLL

INSTALACIÓN DEL ROLLO

INSTALLATION DU ROULEAU



1. Draw a 196cm line from the wall.

1. Dibujar una línea de 196cm desde la pared.

1. Dessiner une ligne de 196cm depuis le mur.

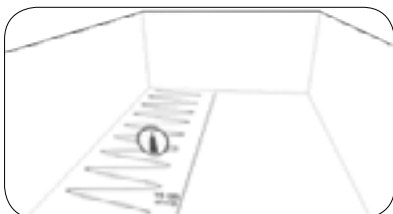

2. Apply the Slc Eco Grinkol glue on the entire surface of the roll except on the 15cm of margin from the line.

2. Aplicar el pegamento Slc Eco Grinkol en toda la superficie del rollo excepto en los 15cm de margen desde la línea.

2. Mettre de la colle Slc Eco Grinkol sur toute la surface du rouleau, en laissant une marge de 15cm depuis la ligne.



3. Allow the glue to air-dry.

3. Dejar airear el pegamento.

3. Laisser la colle s'aérer.



4. Apply the flooring following the line.

4. Aplicar el pavimento siguiendo la línea.

4. Poser le revêtement du sol en suivant la ligne.



5. Press to remove any bubbles that may have appeared.

5. Presionar para eliminar las posibles burbujas que hayan aparecido.

5. Presser pour éliminer les éventuelles bulles qui se sont formées.



6. Repeat the procedure for the next roll, in such a way that they overlap about 4cm approximately.

6. Repetir el procedimiento para el siguiente rollo, de forma que se solapen unos 4cm aproximadamente.

6. Suivre la même procédure pour le deuxième rouleau, en les superposant d'environ 4cm.



7. Cut in the center of the overlapping area, along the seam of the 2 rolls.

7. Cortar en el centro de la zona solapada, a lo largo de la unión de los 2 rollos.

7. Couper au centre de la zone superposée, le long de l'union des deux rouleaux.

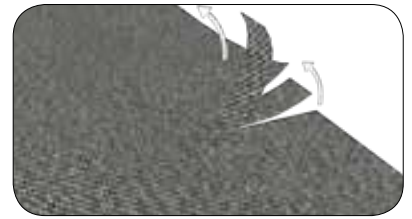

8. Remove the 2 strips of extra material.

* NOTE: for striped designs, adjust the overlapping area until the design coincides.

8. Retirar las 2 tiras de merma.

*NOTA, para diseños rallados ajustar la zona solapada hasta que ajuste el diseño.

8. Retirer les deux bandelettes à rejeter.

* NOTE : pour les dessins à rayures, ajuster la zone chevauchée jusqu'à la superposition du dessin.

9. Cold welding: Check with the manufacturer of these glues.

9. Soldadura en frío: consultar con el fabricante de estas colas.

9. Soudure à froid : consulter le fabricant des colles.



10. Use a metal roller (approx. 80Kg) to remove any air bubbles and facilitate bonding.

10. Pasar un rodillo metálico (aprox. 80Kg) para sacar las posibles burbujas de aire y facilitar el pegado.

10. Passer un rouleau métallique (environ 80kg) pour éliminer les éventuelles bulles d'air et faciliter le collage.

SEALED SEAMS

SELLADO DE UNIONES

SCELLAGE DES UNIONS

Apply the recommended glue on the base flooring and on the back of the

Installation / Instalación / Installation

piece. Glue the material in the proper position for a perfect union.

Aplicar la cola recomendada en el pavimento base y en el reverso de la pieza. Encolar el material en la posición adecuada para obtener una unión perfecta.

Poser la colle recommandée sur le revêtement de base et sur le revers de la pièce. Coller le matériel dans la position adéquate pour obtenir une union parfaite.

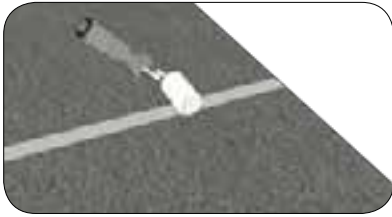

Place the adhesive tape centered on the joint and press it down with a roller.

Colocar la cinta adhesiva centrada en la unión y presionarla con un rodillo.

Placer le ruban adhésif centré sur l'union et le presser avec un rouleau.

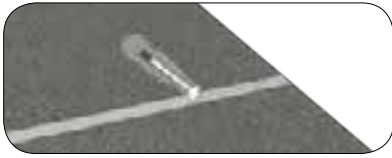

Cut the adhesive tape with a cutter and apply the glue inside the cut.

Remove the tape once the glue is dry.

Cortar la cinta adhesiva con un cúter y aplicar la cola dentro del corte.

Retirar la cinta una vez la cola este seca.

Couper le ruban adhésif avec un cutter et appliquer la colle dans la découpe.

Retirer le ruban lorsque la colle soit sèche.

FINAL FINISH

ACABADO FINAL

FINITION

Use a clean white cloth to remove lint and residue. Use a mild soap for daily/weekly cleaning. Use a vaporeta for deep cleaning, and protect the material in the event of subsequent works.

Clean & Green Active cleaner is recommended for a thorough cleaning after a long period of use.

Usar un trapo blanco y limpio para

eliminar pelusa y residuos. Usar un jabón neutro para la limpieza diaria/semanal. Para limpieza a fondo usar vaporeta y proteger el material en caso de trabajos posteriores.

Para restauración a fondo tras un largo periodo de uso se recomienda el limpiador Clean & Green Active.

Utiliser un chiffon blanc propre pour éliminer les peluches et les déchets.

Utiliser du savon neutre pour le nettoyage journalier/hebdomadaire.

Pour un nettoyage à fond, utiliser un nettoyeur à vapeur et protéger le matériel si des travaux doivent ensuite être effectués.

Pour une restauration à fond après une longue période d'usage, il est recommandé d'utiliser le produit nettoyant Clean & Green Active.

Utiliser un chiffon blanc propre pour éliminer les peluches et les déchets. Utiliser du savon neutre pour le nettoyage journalier/hebdomadaire. Pour un nettoyage à fond, utiliser un nettoyeur à vapeur et protéger le matériel si des travaux doivent ensuite être effectués.

You can see these updated installation instructions by visiting our website www.anticcolonial.com

Puedes revisar estas instrucciones de instalación actualizadas y con más detalle visitando nuestra página web www.anticcolonial.com

Pour réviser ces instructions d'installation, mises à jour et plus détaillées, veuillez visiter notre site Internet www.anticcolonial.com







Wall Contract

—
Graphite
Steel
Diamond
Titanium
Zinc
Cotton
Gravel
Sand
Clay

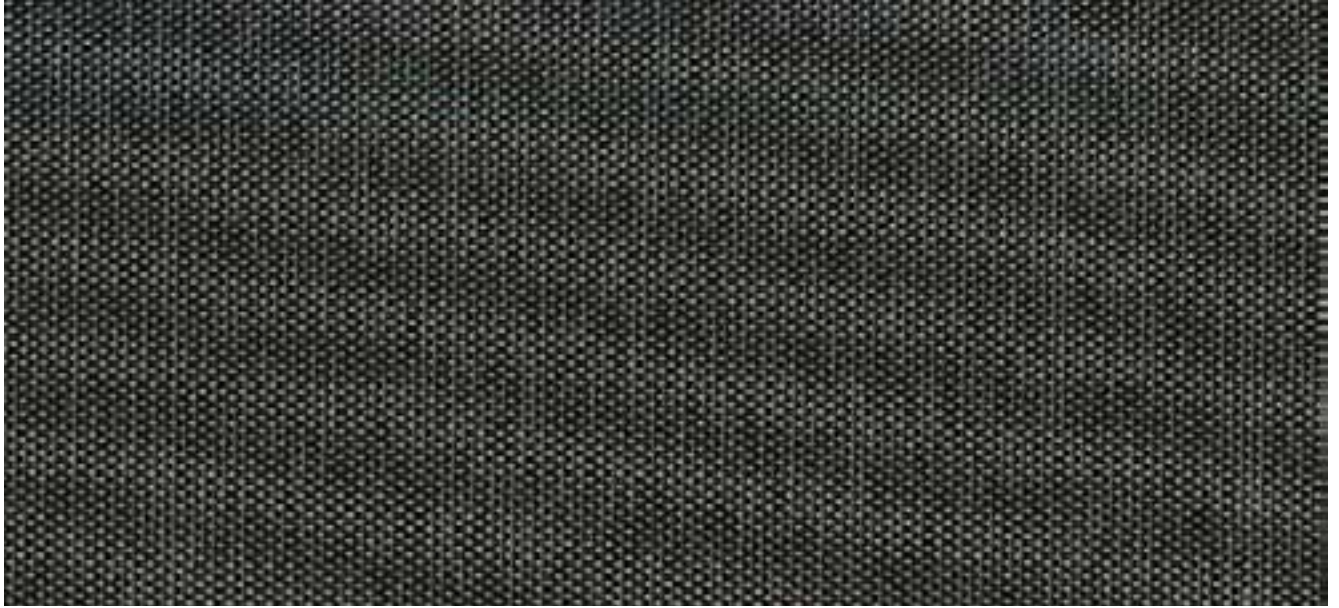

Linkfloor Wall Contract Graphite



Description	Format	Codes	Group	Pcs	m2	Kg
Linkfloor Wall Contract Graphite	100x3000x0,16cm 39 3/8"x1181 1/8"x1/16"	100190429 L167012839	G-228	1 x Cj 12 x Pal	30 x Cj 360 x Pal	35,74 x Cj 428,87 x Pal



Linkfloor Wall Contract Steel



Description	Format	Codes	Group	Pcs	m2	Kg
Linkfloor Wall Contract Steel	100x3000x0,16cm 39 3/8"x1181 1/8"x1/16"	100190424 L167012838	G-228	1 x Cj 12 x Pal	30 x Cj 360 x Pal	35,74 x Cj 428,87 x Pal

Wall Contract

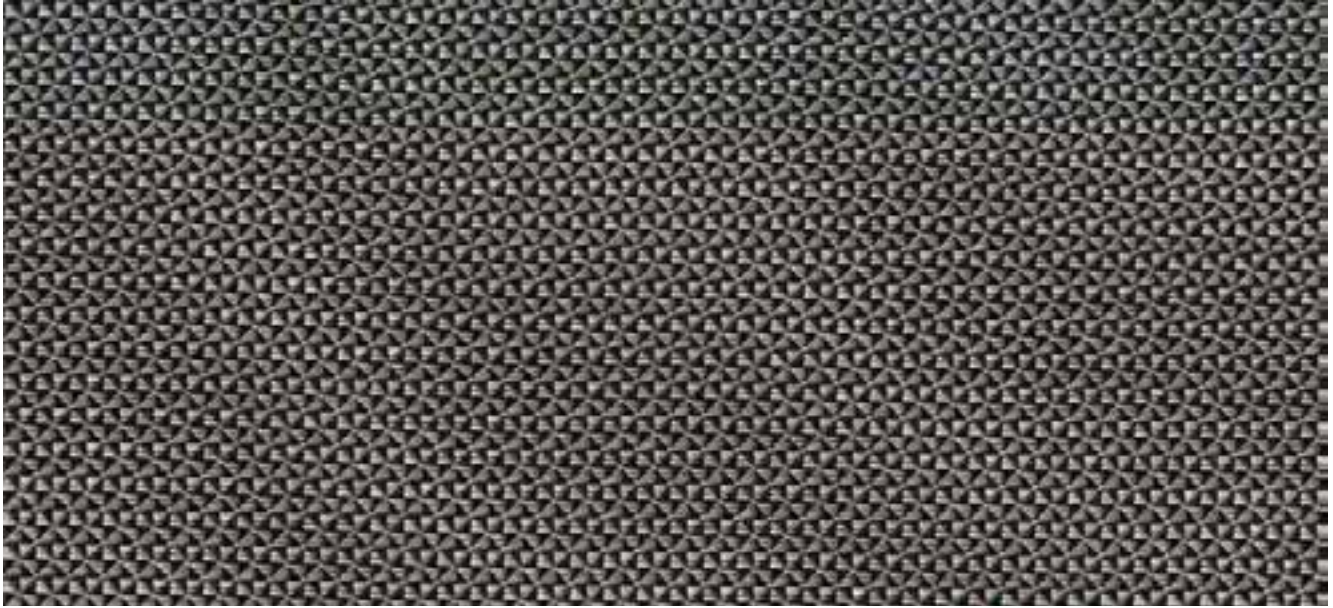

Linkfloor Wall Contract Diamond



TEXTILE



ROLL



WET



GLUING



WARRANTY



MODERATE
COLOR
VARIATION

Description	Format	Codes	Group	Pcs	m2	Kg
Linkfloor Wall Contract Diamond	100x3000x0,16cm 39 3/8"x1181 1/8"x1/16"	100190428 L167012840	G-228	1 x Cj 12 x Pal	30 x Cj 360 x Pal	35,74 x Cj 428,87 x Pal



Linkfloor Wall Contract Titanium



TEXTILE



ROLL



WET



GLUING



WARRANTY



MODERATE
COLOR
VARIATION

Description	Format	Codes	Group	Pcs	m2	Kg
Linkfloor Wall Contract Titanium	100x3000x0,16cm 39 3/8"x1181 1/8"x1/16"	100190432 L167012844	G-228	1 x Cj 12 x Pal	30 x Cj 360 x Pal	35,74 x Cj 428,87 x Pal



Linkfloor Wall Contract Zinc



Description	Format	Codes	Group	Pcs	m2	Kg
Linkfloor Wall Contract Zinc	100x3000x0,16cm 39 3/8"x1181 1/8"x1/16"	100190416 L167012837	G-228	1 x Cj 12 x Pal	30 x Cj 360 x Pal	35,74 x Cj 428,87 x Pal



Linkfloor Wall Contract Cotton



Description	Format	Codes	Group	Pcs	m2	Kg
Linkfloor Wall Contract Cotton	100x3000x0,16cm 39 3/8"x1181 1/8"x1/16"	100190418 L167012836	G-228	1 x Cj 12 x Pal	30 x Cj 360 x Pal	35,74 x Cj 428,87 x Pal

Wall Contract



Linkfloor Wall Contract Gravel



TEXTILE



ROLL



WET



GLUING



WARRANTY



MODERATE COLOR VARIATION

Description	Format	Codes	Group	Pcs	m2	Kg
Linkfloor Wall Contract Gravel	100x3000x0,16cm 39 3/8"x1181 1/8"x1/16"	100190450 L167012843	G-228	1 x Cj 12 x Pal	30 x Cj 360 x Pal	35,74 x Cj 428,87 x Pal



Linkfloor Wall Contract Clay



TEXTILE



ROLL



WET



GLUING



WARRANTY



MODERATE COLOR VARIATION

Description	Format	Codes	Group	Pcs	m2	Kg
Linkfloor Wall Contract Clay	100x3000x0,16cm 39 3/8"x1181 1/8"x1/16"	100190441 L167012842	G-228	1 x Cj 12 x Pal	30 x Cj 360 x Pal	35,74 x Cj 428,87 x Pal



Linkfloor Wall Contract Sand

- 
TEXTILE
- 
ROLL
- 
WET
- 
GLUING
- 
WARRANTY
- 
MODERATE
COLOR
VARIATION

Description	Format	Codes	Group	Pcs	m2	Kg
Linkfloor Wall Contract Sand	100x3000x0,16cm 39 3/8"x1181 1/8"x1/16"	100190431 L167012845	G-228	1 x Cj 12 x Pal	30 x Cj 360 x Pal	35,74 x Cj 428,87 x Pal



BEFORE THE INSTALLATION

ANTES DE LA INSTALACIÓN

AVANT LA POSE



Store the material horizontally and without any weight over it. Check and make sure that all the content is part of the same reference and that the quantity is the requested one.

Almacenar el material en posición horizontal y sin peso encima. Revisar y asegurarse que todo el contenido forma parte de la misma referencia y que la cantidad es la solicitada.

Stocker le matériel en position horizontale et sans poids au-dessus. Réviser et vérifier que tout le contenu fait partie de la même référence et que la quantité est celle demandée.

SURFACE PREPARATION

PREPARACIÓN DEL SOPORTE

PRÉPARATION DU SUPPORT



Bases that are evenly dry, absorbent, flat, resistant, dust-free, and free from detached pieces, varnishes and oils. Moisture: for cement bases, max 2.5-3% and for plaster or anhydride, max 0.5%.

Bases uniformemente secas, absorbentes, planas, resistentes, libres de polvo, partes desprendidas, barnices y aceites. Humedad: para bases de cemento, máx 2,5-3% y para las de yeso o anhídrido, máx 0,5%.

Bases uniformément sèches, absorbantes, plates, résistantes, sans poussière, parties détachées, vernis et huiles. Humidité : pour des bases de ciment, maximum 2,5 à 3%, et pour celles en plâtre ou anhydride, maximum 0,5%.

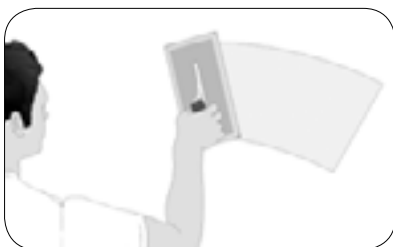

Smooth down surfaces that are not smooth enough. See manufacturer recommendations for the adhesive for each substrate.

Alisar las superficies no suficientemente lisas. Ver recomendaciones del fabricante sobre el adhesivo para cada soporte.

Lisser les surfaces qui ne sont pas suffisamment lisses. Consulter les recommandations du fabricant concernant l'adhésif pour chaque support.

INSTALLATION INSTRUCTIONS

INSTRUCCIONES DE INSTALACIÓN

INSTRUCTIONS DE POSE



Measure the wall length and make a design of how to place the boards.

Medir la longitud de la pared y hacer un diseño de cómo situar las tiras.

Mesurer la longueur de la cloison et faire un dessin de la pose des bandes.

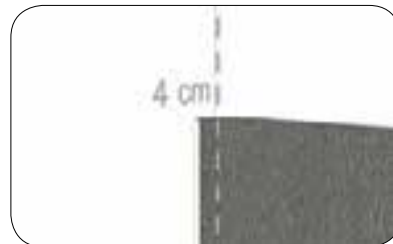

Measure the wall height and cut boards adding 4cm on each side to compensate for uneven floor and ceiling. If there is a baseboard, the distance to measure shall be from it to the ceiling.

Medir la altura de la pared y cortar tiras añadiendo 4cm por cada lado para compensar las irregularidades en suelo y techo. En caso de tener zócalo, la distancia a medir será desde este hasta el techo.

Mesurer la hauteur de la cloison et couper les bandes en ajoutant 4cm de chaque côté pour compenser les irrégularités du sol et du plafond. S'il y a un socle, mesurer la distance de celui-ci au plafond.



Number the boards and install always in the same direction to avoid visual variations. Draw a vertical line with a pencil, 98cm from the first corner.

Numerar las tiras e instalar siempre en la misma dirección para evitar variaciones visuales. Marcar con lápiz una línea vertical a 98cm de la primera esquina.

Numéroter les bandes et les installer toujours dans le même sens pour éviter des variations visuelles. Marquer avec un crayon une ligne verticale à 98cm du premier coin.

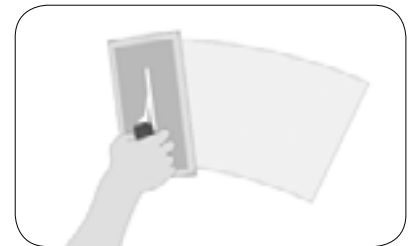

Spread Kerakoll's Slc® Eco Grinkol, the recommended adhesive/glue for wall coverings, evenly with a finely toothed trowel adding 20cm extra (from the line). Near the ceiling and the floor, apply more generously.

Extender el adhesivo/cola recomendado para revestimientos murales, Slc® Eco Grinkol de Kerakoll, regularmente con una espátula finamente dentada añadiendo 20cm extra (a partir de la línea). Cerca del techo y el suelo la aplicación debe ser más generosa.

Étaler l'adhésif ou la colle recommandés pour les revêtements pour mur, Slc® Eco Grinkol de Kerakoll, de façon régulière avec une spatule finement dentelée et ajouter 20cm supplémentaires (à partir de la ligne). Appliquer plus de produit près du plafond et du sol.



Install the first strip on the glued surface along the line. There shall be left-over material both at the corner and the ceiling and the floor or baseboard. Press with a trowel throughout the material to remove any air. On outer corners, we recommend covering whenever possible with at least 30cm. If not possible, cut on the corner and start again.

Colocar la primera tira sobre la superficie encolada a lo largo de la línea. Debe sobrar material tanto en la esquina como el techo y el suelo o zócalo. Presionar con espátula todo el material para eliminar el aire. En las

Installation / Instalación / Installation

esquinas exteriores, se recomienda cubrir siempre que sea posible, como mínimo a 30cm. De no ser posible, cortar sobre la esquina y empezar de nuevo.

Placer la première bande sur la surface encollée le long de la ligne. Du matériel excédant doit rester aussi bien au coin, au plafond et au sol ou au socle. Presser tout le matériel avec la spatule pour éliminer l'air. Aux coins extérieurs, il est toujours recommandé de recouvrir, lorsque cela est possible, à une distance minimale de 30cm. Dans le cas contraire, couper sur le coin et recommencer.



Install the strips side by side without overlapping. The glue shall not come out through the joint. Press with a trowel along the joint.

Aplicar las tiras una al lado de la otra sin solapar. La cola no debe sobresalir por la junta. Presionar con espátula a lo largo de la junta.

Placer les bandes une à côté de l'autre sans les superposer. La colle ne doit pas

dépasser par le joint. Presser avec la spatule le long du joint.



Cut the leftover material at the corners, ceiling, and baseboard using a trowel and a cutter.

Cortar el material sobrante en esquinas, techo y suelo o zócalo con una espátula y un cortador.

Couper le matériel excédentaire des coins, du plafond et du sol ou du socle à l'aide d'une spatule et d'une découpeuse.

You can see these updated installation instructions by visiting our website www.anticcolonial.com

Puedes revisar estas instrucciones de instalación actualizadas y con más detalle visitando nuestra página web www.anticcolonial.com

Pour réviser ces instructions d'installation, mises à jour et plus détaillées, veuillez visiter notre site Internet www.anticcolonial.com



Floor Coverings Linkfloor Wall Contract Cotton

Wall Contract Custom

-

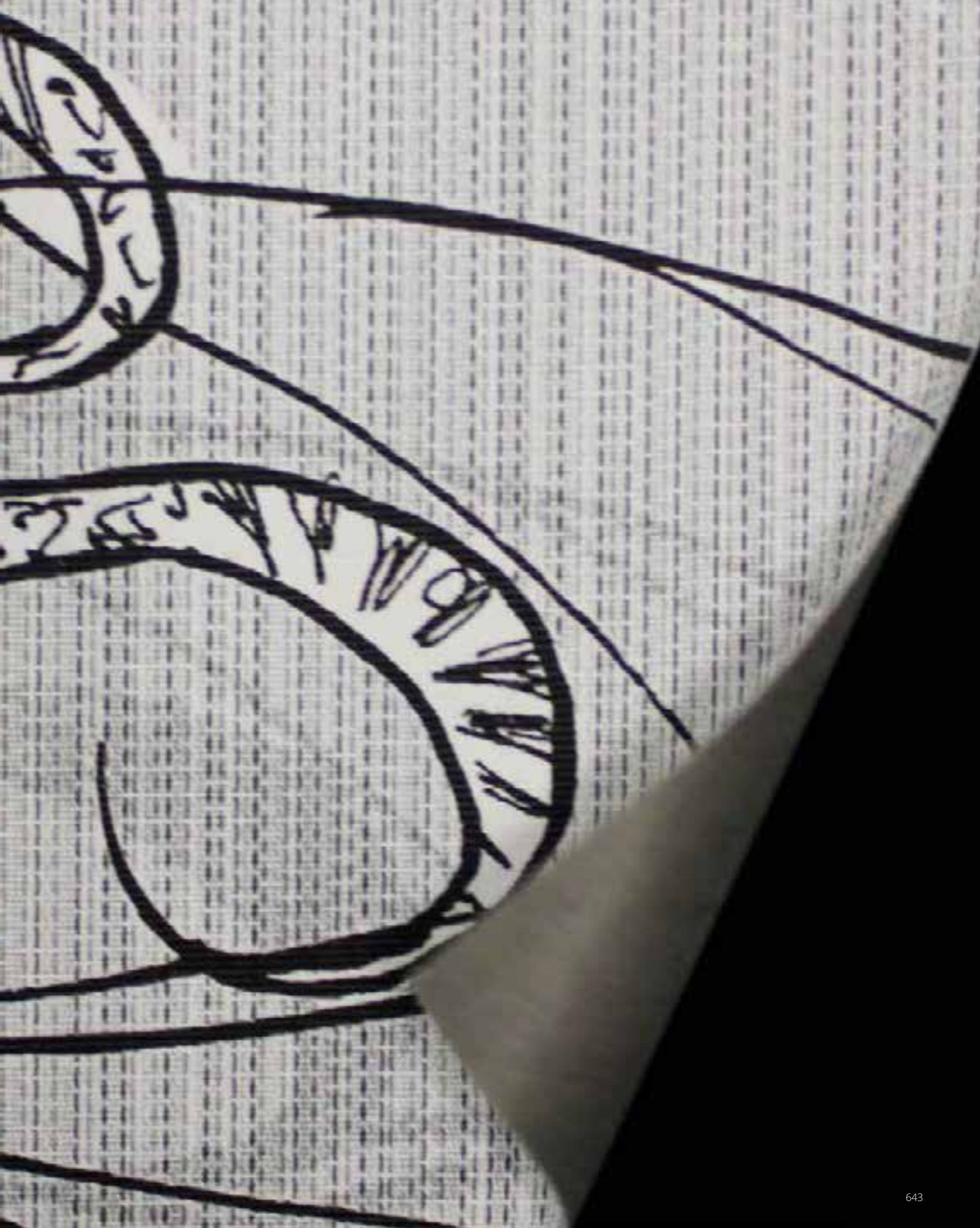

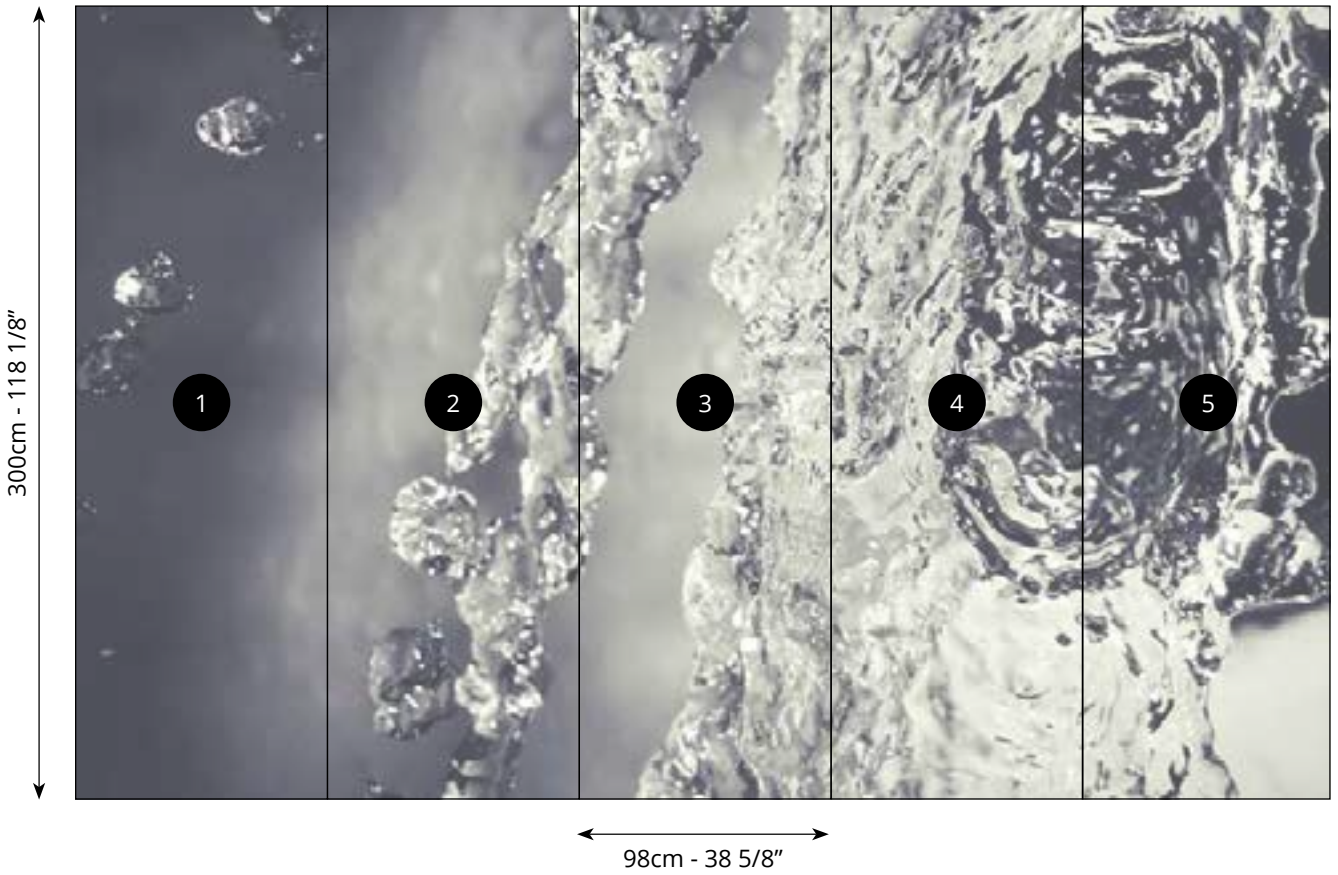

Linkfloor Wall Contract Custom

98x300x0,16cm - 38 5/8"x118 1/8"x1/16" G-272



TEXTILE



ROLL



WET



GLUING



WARRANTY

Linkfloor Wall Contract Custom incorporates an image in its design using digital printing that fuses perfectly with vinyl fabric. This material meets all the Linkfloor characteristics and conditions, also providing a customization that makes it unique and differentiating. In this case, printing of the desired image is done on the vinyl layer of the white Linkfloor.

Linkfloor Wall Contract Custom incorpora en su diseño una imagen mediante impresión digital que se funde a la perfección con el tejido vinílico. Este material reúne todas las características y condiciones de Linkfloor, aportando además una personalización que lo vuelve inigualable y diferencial. Para este caso la impresión de la imagen deseada se realiza sobre la capa vinílica del Linkfloor en blanco.

Une image personnalisée est intégrée au design de Linkfloor Wall Contract Custom par impression numérique pour se fondre à la perfection avec le tissu vinylique. Ce matériau inclut l'ensemble des caractéristiques et des conditions de Linkfloor, tout en proposant une personnalisation qui le rend différent et incomparable. Dans ce cas, l'impression de l'image souhaitée s'effectue sur la couche vinylique de Linkfloor en blanc.





Loose Lay Contract

—
Graphite
Diamond
Titanium
Zinc
Sand
Cotton
Gravel
Clay
Steel

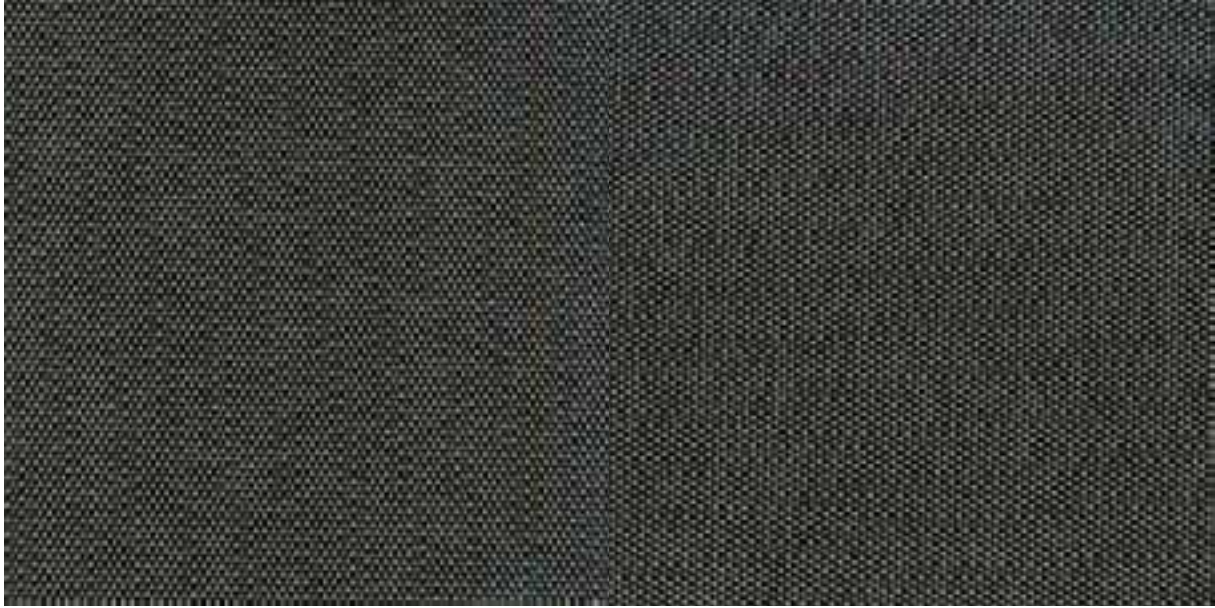

Linkfloor Loose Lay Contract Graphite



Description	Format	Codes	Group	Pcs	m2	Kg
Linkfloor Loose Lay Contract Graphite	50x50x0,42cm 19 5/8"x19 5/8"x1/8"	100179387 L167012771	G-238	12 x Cj 672 x Pal	3 x Cj 168 x Pal	17,27 x Cj 967,01 x Pal
Aluminium Skirting / Zócalo Aluminio / Plinthe Aluminium	8x225cm 3 1/8"x88 5/8"	100128267 L167901793	G-121	12 x Cj 696 x Pal	2,16 x Cj 125,28 x Pal	19,45 x Cj 1128,22 x Pal
Aluminium Linkfloor Adh Profile / Perfil Adh Linkfloor Aluminio / Profilé Adh Linkfloor Aluminium	3,5x270cm 1 3/8"x106 1/4"	100174756 L167012669	G-121	10 x Cj 1000 x Pal	0,95 x Cj 94,50 x Pal	3,87 x Cj 387 x Pal

*The ADH Aluminium Profile may be used as a transition or levelling profile.
 El Perfil ADH Aluminio se puede utilizar como perfil de transición e igualación.
 Le profilé ADH aluminium peut être utilisé comme profilé de transition ou d'égalisation.

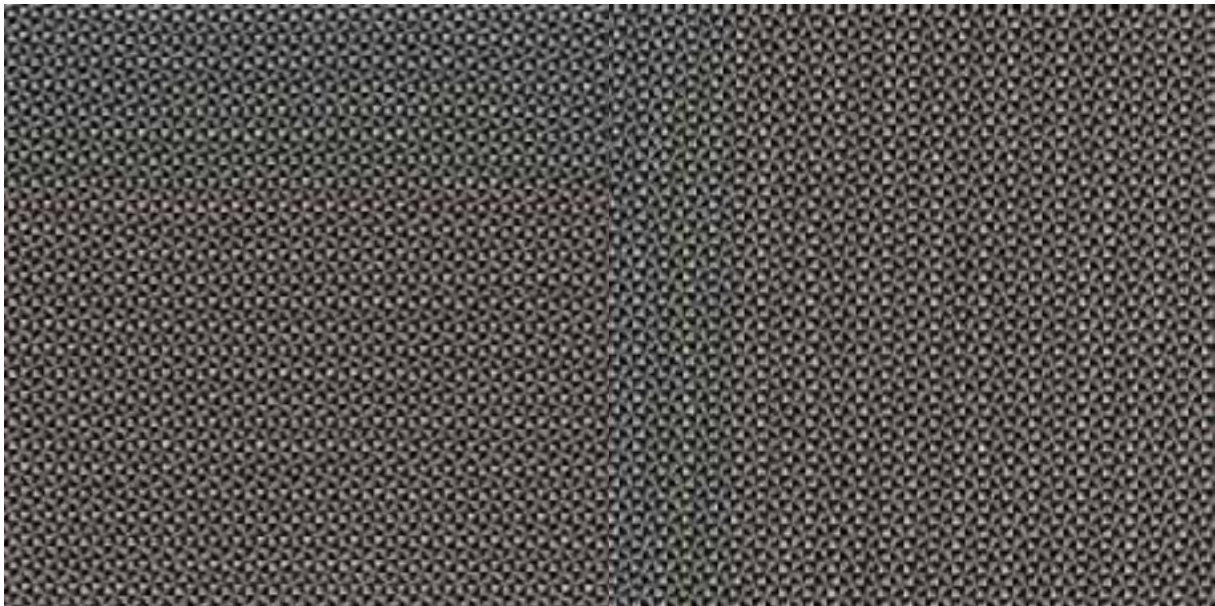

Linkfloor Loose Lay Contract Diamond



Description	Format	Codes	Group	Pcs	m2	Kg
Linkfloor Loose Lay Contract Diamond	50x50x0,42cm 19 5/8"x19 5/8"x1/8"	100179397 L167012770	G-238	12 x Cj 672 x Pal	3 x Cj 168 x Pal	17,27 x Cj 967,01 x Pal
Aluminium Skirting / Zócalo Aluminio / Plinthe Aluminium	8x225cm 3 1/8"x88 5/8"	100128267 L167901793	G-121	12 x Cj 696 x Pal	2,16 x Cj 125,28 x Pal	19,45 x Cj 1128,22 x Pal
Aluminium Linkfloor Adh Profile / Perfil Adh Linkfloor Aluminio / Profilé Adh Linkfloor Aluminium	3,5x270cm 1 3/8"x106 1/4"	100174756 L167012669	G-121	10 x Cj 1000 x Pal	0,95 x Cj 94,50 x Pal	3,87 x Cj 387 x Pal

*The ADH Aluminium Profile may be used as a transition or levelling profile.
 El Perfil ADH Aluminio se puede utilizar como perfil de transición e igualación.
 Le profilé ADH aluminium peut être utilisé comme profilé de transition ou d'égalisation.

Loose Lay Contract



Linkfloor Loose Lay Contract Titanium



Description	Format	Codes	Group	Pcs	m2	Kg
Linkfloor Loose Lay Contract Titanium	50x50x0,42cm 19 5/8"x19 5/8"x1/8"	100179406 L167012772	G-238	12 x Cj 672 x Pal	3 x Cj 168 x Pal	17,27 x Cj 967,01 x Pal
Aluminium Skirting / Zócalo Aluminio / Plinthe Aluminium	8x225cm 3 1/8"x88 5/8"	100128267 L167901793	G-121	12 x Cj 696 x Pal	2,16 x Cj 125,28 x Pal	19,45 x Cj 1128,22 x Pal
Aluminium Linkfloor Adh Profile / Perfil Adh Linkfloor Aluminio / Profilé Adh Linkfloor Aluminium	3,5x270cm 1 3/8"x106 1/4"	100174756 L167012669	G-121	10 x Cj 1000 x Pal	0,95 x Cj 94,50 x Pal	3,87 x Cj 387 x Pal

*The ADH Aluminium Profile may be used as a transition or levelling profile.
 El Perfil ADH Aluminio se puede utilizar como perfil de transición e igualación.
 Le profilé ADH aluminium peut être utilisé comme profilé de transition ou d'égalisation.



Linkfloor Loose Lay Contract Zinc



Description	Format	Codes	Group	Pcs	m2	Kg
Linkfloor Loose Lay Contract Zinc	50x50x0,42cm 19 5/8"x19 5/8"x1/8"	100179422 L167012773	G-238	12 x Cj 672 x Pal	3 x Cj 168 x Pal	17,27 x Cj 967,01 x Pal
Aluminium Skirting / Zócalo Aluminio / Plinthe Aluminium	8x225cm 3 1/8"x88 5/8"	100128267 L167901793	G-121	12 x Cj 696 x Pal	2,16 x Cj 125,28 x Pal	19,45 x Cj 1128,22 x Pal
Aluminium Linkfloor Adh Profile / Perfil Adh Linkfloor Aluminio / Profilé Adh Linkfloor Aluminium	3,5x270cm 1 3/8"x106 1/4"	100174756 L167012669	G-121	10 x Cj 1000 x Pal	0,95 x Cj 94,50 x Pal	3,87 x Cj 387 x Pal

*The ADH Aluminium Profile may be used as a transition or levelling profile.
 El Perfil ADH Aluminio se puede utilizar como perfil de transición e igualación.
 Le profilé ADH aluminium peut être utilisé comme profilé de transition ou d'égalisation.



Linkfloor Loose Lay Contract Sand



Description	Format	Codes	Group	Pcs	m2	Kg
Linkfloor Loose Lay Contract Sand	50x50x0,42cm 19 5/8"x19 5/8"x1/8"	100179420 L167012782	G-238	12 x Cj 672 x Pal	3 x Cj 168 x Pal	17,27 x Cj 967,01 x Pal
Aluminium Skirting / Zócalo Aluminio / Plinthe Aluminium	8x225cm 3 1/8"x88 5/8"	100128267 L167901793	G-121	12 x Cj 696 x Pal	2,16 x Cj 125,28 x Pal	19,45 x Cj 1128,22 x Pal
Aluminium Linkfloor Adh Profile / Perfil Adh Linkfloor Aluminio / Profilé Adh Linkfloor Aluminium	3,5x270cm 1 3/8"x106 1/4"	100174756 L167012669	G-121	10 x Cj 1000 x Pal	0,95 x Cj 94,50 x Pal	3,87 x Cj 387 x Pal

*The ADH Aluminium Profile may be used as a transition or levelling profile.
 El Perfil ADH Aluminio se puede utilizar como perfil de transición e igualación.
 Le profilé ADH aluminium peut être utilisé comme profilé de transition ou d'égalisation.

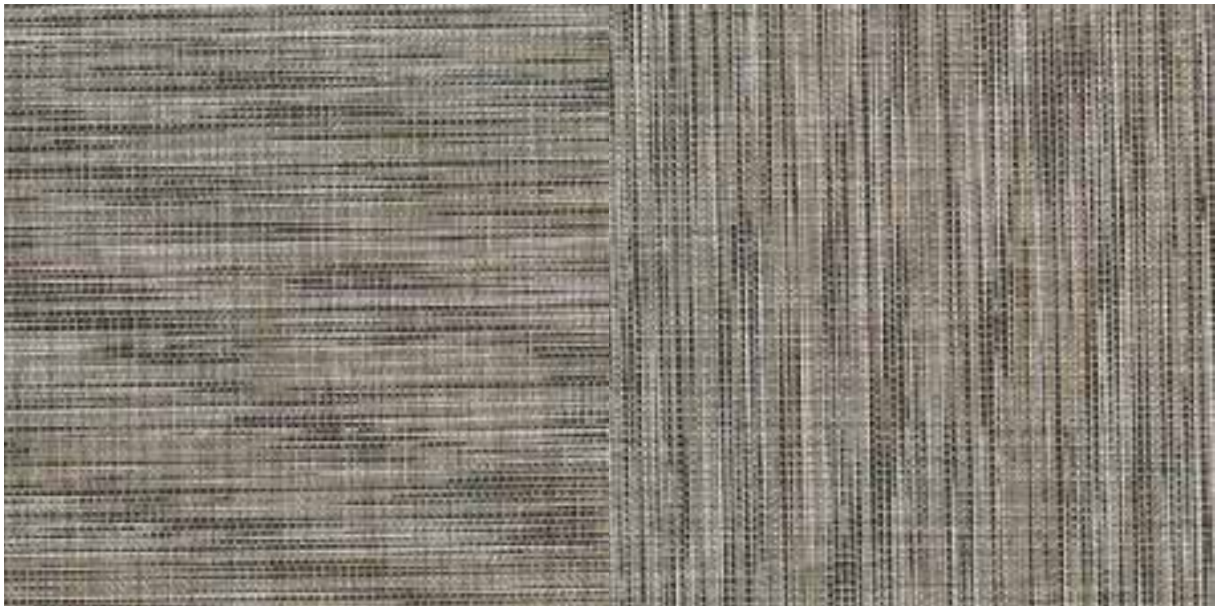

Linkfloor Loose Lay Contract Cotton



Description	Format	Codes	Group	Pcs	m2	Kg
Linkfloor Loose Lay Contract Cotton	50x50x0,42cm 19 5/8"x19 5/8"x1/8"	100179386 L167012776	G-238	12 x Cj 672 x Pal	3 x Cj 168 x Pal	17,27 x Cj 967,01 x Pal
Aluminium Skirting / Zócalo Aluminio / Plinthe Aluminium	8x225cm 3 1/8"x88 5/8"	100128267 L167901793	G-121	12 x Cj 696 x Pal	2,16 x Cj 125,28 x Pal	19,45 x Cj 1128,22 x Pal
Aluminium Linkfloor Adh Profile / Perfil Adh Linkfloor Aluminio / Profilé Adh Linkfloor Aluminium	3,5x270cm 1 3/8"x106 1/4"	100174756 L167012669	G-121	10 x Cj 1000 x Pal	0,95 x Cj 94,50 x Pal	3,87 x Cj 387 x Pal

*The ADH Aluminium Profile may be used as a transition or levelling profile.
 El Perfil ADH Aluminio se puede utilizar como perfil de transición e igualación.
 Le profilé ADH aluminium peut être utilisé comme profilé de transition ou d'égalisation.

Loose Lay Contract

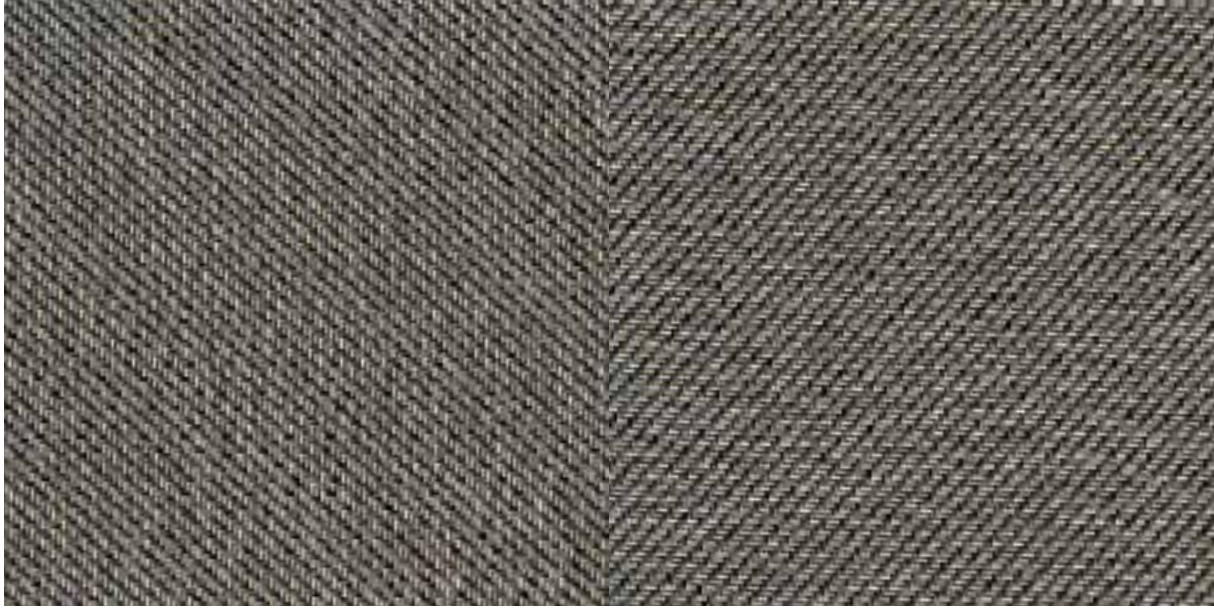

Linkfloor Loose Lay Contract Gravel



Description	Format	Codes	Group	Pcs	m2	Kg
Linkfloor Loose Lay Contract Gravel	50x50x0,42cm 19 5/8"x19 5/8"x1/8"	100179404 L167012778	G-238	12 x Cj 672 x Pal	3 x Cj 168 x Pal	17,27 x Cj 967,01 x Pal
Aluminium Skirting / Zócalo Aluminio / Plinthe Aluminium	8x225cm 3 1/8"x88 5/8"	100128267 L167901793	G-121	12 x Cj 696 x Pal	2,16 x Cj 125,28 x Pal	19,45 x Cj 1128,22 x Pal
Aluminium Linkfloor Adh Profile / Perfil Adh Linkfloor Aluminio / Profilé Adh Linkfloor Aluminium	3,5x270cm 1 3/8"x106 1/4"	100174756 L167012669	G-121	10 x Cj 1000 x Pal	0,95 x Cj 94,50 x Pal	3,87 x Cj 387 x Pal

*The ADH Aluminium Profile may be used as a transition or levelling profile.
 El Perfil ADH Aluminio se puede utilizar como perfil de transición e igualación.
 Le profilé ADH aluminium peut être utilisé comme profilé de transition ou d'égalisation.



Linkfloor Loose Lay Contract Clay

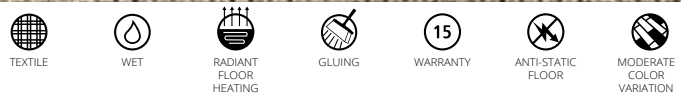

Description	Format	Codes	Group	Pcs	m2	Kg
Linkfloor Loose Lay Contract Clay	50x50x0,42cm 19 5/8"x19 5/8"x1/8"	100179412 L167012787	G-238	12 x Cj 672 x Pal	3 x Cj 168 x Pal	17,27 x Cj 967,01 x Pal
Aluminium Skirting / Zócalo Aluminio / Plinthe Aluminium	8x225cm 3 1/8"x88 5/8"	100128267 L167901793	G-121	12 x Cj 696 x Pal	2,16 x Cj 125,28 x Pal	19,45 x Cj 1128,22 x Pal
Aluminium Linkfloor Adh Profile / Perfil Adh Linkfloor Aluminio / Profilé Adh Linkfloor Aluminium	3,5x270cm 1 3/8"x106 1/4"	100174756 L167012669	G-121	10 x Cj 1000 x Pal	0,95 x Cj 94,50 x Pal	3,87 x Cj 387 x Pal

*The ADH Aluminium Profile may be used as a transition or levelling profile.
 El Perfil ADH Aluminio se puede utilizar como perfil de transición e igualación.
 Le profilé ADH aluminium peut être utilisé comme profilé de transition ou d'égalisation.



Linkfloor Loose Lay Contract Steel



TEXTILE



WET

RADIANT
FLOOR
HEATING

GLUING



WARRANTY

ANTI-STATIC
FLOORMODERATE
COLOR
VARIATION

Description	Format	Codes	Group	Pcs	m2	Kg
Linkfloor Loose Lay Contract Steel	50x50x0,42cm 19 5/8"x19 5/8"x1/8"	100179421 L167012785	G-238	12 x Cj 672 x Pal	3 x Cj 168 x Pal	17,27 x Cj 967,01 x Pal
Aluminium Skirting / Zócalo Aluminio / Plinthe Aluminium	8x225cm 3 1/8"x88 5/8"	100128267 L167901793	G-121	12 x Cj 696 x Pal	2,16 x Cj 125,28 x Pal	19,45 x Cj 1128,22 x Pal
Aluminium Linkfloor Adh Profile / Perfil Adh Linkfloor Aluminio / Profilé Adh Linkfloor Aluminium	3,5x270cm 1 3/8"x106 1/4"	100174756 L167012669	G-121	10 x Cj 1000 x Pal	0,95 x Cj 94,50 x Pal	3,87 x Cj 387 x Pal

*The ADH Aluminium Profile may be used as a transition or levelling profile.
El Perfil ADH Aluminio se puede utilizar como perfil de transición e igualación.
Le profilé ADH aluminium peut être utilisé comme profilé de transition ou d'égalisation.



SUBSTRATE REQUIREMENTS

REQUISITOS DE LA BASE

EXIGENCES DE LA SURFACE DE BASE

Depending on the surface:

1. Cement: dry, smooth, and free from dust, solvents, paint, wax, grease, oil, asphalt sealing compounds, and other materials. The surface must be hard and dense, and free from dust and cracks. New cement floors must be dry (at least 6 weeks from their completion).

Según la superficie:

1. Cemento: seco, liso y libre de polvo, disolvente, pintura, cera, grasa, aceite, compuestos de sellado de asfalto y otros materiales. Superficie dura y densa y libre de polvo y grietas. Suelos nuevos de cemento deben estar secos (al menos 6 semanas desde su finalización).

En fonction de la surface :

1. Ciment : sec, lisse et sans poussière, solvant, peinture, cire, gras, huile, composés de scellage asphaltique et d'autres matériaux. Surface dure et dense, sans poussière ni fissures. Les sols neufs en ciment doivent être secs (au moins 6 semaines depuis la finition).

2. Wood: smooth, flat surfaces, in good structural condition, and free from warping.

2. Madera: superficies lisas, planas, en buenas condiciones estructurales y libres de deformaciones.

2. Bois : surfaces lisses, plates, en bonnes conditions structurales et sans déformations.

Surface dirt affects the performance of the adhesive, and can show on the surface of the installed product.

La suciedad superficial afecta al rendimiento del adhesivo y puede marcarse en la superficie del producto instalado.

La saleté superficielle nuit au rendement de l'adhésif et peut laisser des traces sur la surface du produit installé.

Humidity less than 2.5-3% for cement substrates, and less than 0.5% for gypsum or anhydrite.

Humedad menor a 2,5-3% para sustratos de cemento y menor a 0,5% para yeso o anhidrita.

Humidité inférieure à 2,5 à 3% pour les substrats de ciment et inférieure à 0,5% pour le plâtre et l'anhydrite.

ADHESIVES

ADHESIVOS

COLLES

L'Antic Colonial recommends

Ultrabond Eco Tack LVT.

Before installing, we recommend drawing a planning taking into account the direction of the tiles, marked on the back of each one.

L'Antic Colonial recomienda Ultrabond Eco Tack LVT.

Antes de la instalación, se recomienda dibujar un planning con las direcciones de las losetas, marcadas en el dorso de cada una de ellas.

L'Antic Colonial recommande l'utilisation d'Ultrabond Eco Tack LVT.

Avant l'installation, il est recommandé de dessiner un plan avec les directions des carreaux, marqués sur le revers de chacun.

RADIANT FLOOR HEATING

CALEFACCIÓN RADIANTE

PLANCHER CHAUFFANT

29°C maximum temperature. Install 7 days after the installation of the radiant floor heating. The heating shall be switched off for at least 48h before, during, and after installation.

Temperatura máxima 29°C. Instalar 7 días después de la instalación del suelo radiante. Calefacción apagada al menos 48h antes, durante y después de la instalación.

Température maximale: 29°C. Installer le matériel 7 jours après la pose du plancher rayonnant. Éteindre le chauffage au moins 48h avant, pendant et après l'installation.

GENERAL CONDITIONS

CONDICIONES GENERALES

CONDITIONS GÉNÉRALES

Install at 15°C maximum temperature. Check that all the material comes from the same line and that it has been manufactured in the same batch. Linkfloor Loose Lay is a vinyl fabric, so it has the qualities of a fabric and can undergo variations over time that affect its color.

Instalar a una temperatura máxima de 15°C. Revisar que todo el material procede de la misma colección y que está hecho en el mismo lote. Linkfloor Loose Lay es un tejido vinílico con lo que tiene las cualidades del tejido y puede sufrir variaciones con el tiempo que afectan a su color.

L'installation doit être faite à une température maximale de 15 °C. Réviser que tout le matériel appartient à la même collection et qu'il a été fabriqué dans le même lot. Linkfloor Loose Lay est un tissu en vinyle. Il possède donc les qualités du tissu et peut souffrir des variations dans le temps qui altèrent sa couleur.

TILE INSTALATIONS

INSTALACIÓN DE LAS LOSETAS

INSTALLATION DES DALLES

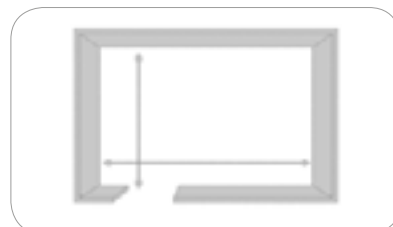

1. Draw two lines perpendicular to each other, parallel to the walls of the room.

1. Dibujar dos líneas perpendiculares entre sí paralelas a las paredes de la habitación.

1. Dessiner deux lignes perpendiculaires entre elles et parallèles aux murs de la pièce.



2. Spread the adhesive evenly throughout the substrate.

2. Disperse el adhesivo uniformemente sobre toda la base.

2. Répandre l'adhésif de façon uniforme sur toute la base.

3. Wait until the water has completely evaporated before laying the floor (follow the specifications of the adhesive.) If it is installed before the glue is completely dry, the bonding may be permanent.

3. Esperar a que el agua se evapore completamente antes de colocar el suelo (siga las especificaciones del adhesivo). Si se instala antes que la cola se haya secado completamente, la adhesión puede ser permanente.

3. Attendre que l'eau s'évapore complètement avant de placer le revêtement du sol (suivez les spécifications de l'adhésif). Si vous l'installez avant que la colle soit complètement sèche, l'adhésion peut être permanente.

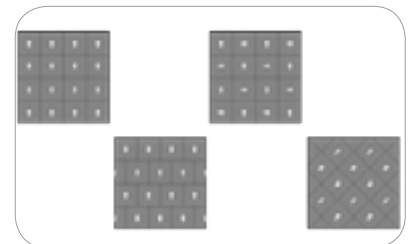

4. It is possible that the design looks differently depending on the direction of the tiles (arrow marked on the reverse). See recommended installation systems.

4. Es posible que el diseño luzca de formas diferentes dependiendo de la dirección de las losetas (flecha marcada en el reverso). Ver sistemas de instalación recomendados.

4. Le dessin peut avoir différences apparences en fonction de la direction des carreaux (flèche marquée sur le revers). Voir les systèmes d'installation recommandés.

Installation / Instalación / Installation

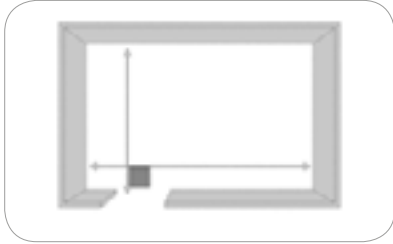

5. Install the first tile at the drawn cross.

5. Colocar la primera loseta desde la cruz dibujada.

5. Placer le premier carreau à partir de la croix dessinée.

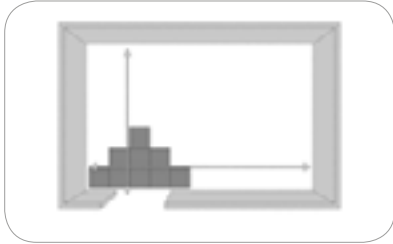

6. Follow the lines to progressively fill the entire surface.

6. Seguir las líneas para llenar progresivamente toda la superficie.

6. Suivre les lignes pour remplir progressivement toute la surface.

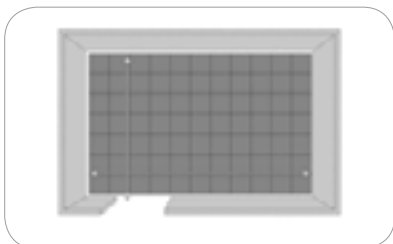

7. First complete the installation of the tiles that do not need to be cut.

7. Completar primero la instalación de las losetas que no hay que cortar.

7. Compléter d'abord la pose des carreaux qui ne doivent pas être découpés.

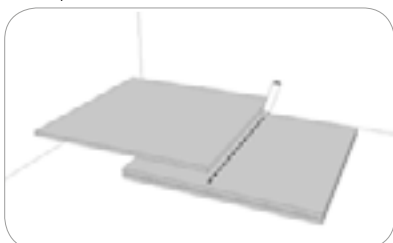

8. Fill the perimeter by cutting the pieces before installing them. Position the tile that must be cut over the last one installed. Push another tile over them until they contact the wall, and cut using it as a mold.

8. Rellenar el perímetro, cortando las piezas antes de instalarlas. Situar la loseta que debe cortarse encima de la última instalada. Empujar otra loseta superior a estas hasta contactar con la pared y cortar utilizándola de molde.

8. Remplir le périmètre en coupant les

pièces avant la pose. Situer le carreau qui doit être coupé sur le dernier installé. Pousser un autre carreau supérieur à ceux-ci jusqu'à entrer en contact avec le mur et le couper en l'utilisant comme moule.

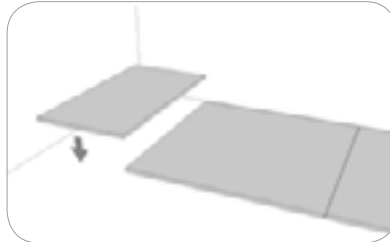

9. Once it is cut, install it as usual.

9. Una vez cortada, colocarla normalmente.

9. Après la découpe, le placer normalement.

FINAL FINISH

ACABADO FINAL

FINITION

Use a clean white cloth to clean the floor surface. Use Clean&Green Active for everyday cleaning. Mop the entire surface to ensure a thorough cleaning.

Usar un paño blanco y limpio para limpiar el suelo. Usar Clean&Green Active para la limpieza diaria. Fregar la superficie para asegurar una limpieza

completa.

Utiliser un chiffon blanc et propre pour nettoyer le sol. Utiliser le produit nettoyant Clean&Green Active pour le nettoyage quotidien. Laver la surface pour assurer un nettoyage complet.

You can see these updated installation instructions by visiting our website www.anticcolonial.com

Puedes revisar estas instrucciones de instalación actualizadas y con más detalle visitando nuestra página web www.anticcolonial.com

Pour réviser ces instructions d'installation, mises à jour et plus détaillées, veuillez visiter notre site Internet www.anticcolonial.com



Oak

—
Dark
Natural
Grey
White





Linkfloor Oak Dark



Description	Format	Codes	Group	Pcs	m2	Kg
Linkfloor Oak Dark	30,5x123x0,55cm 12"x48 3/8"x1/4"	100126716 L167012132	G-252	8 x Cj 408 x Pal	3,01 x Cj 153,06 x Pal	21,73 x Cj 1108,13 x Pal
Skirting / Zócalo / Plinthe	8x220 3 1/8"x86 5/8"	100177557 L167012731	G-121	14 x Cj 560 x Pal	2,46 x Cj 98,56 x Pal	19,32 x Cj 772,80 x Pal
Aluminium Skirting / Zócalo Aluminio / Plinthe Aluminium	8x225cm 3 1/8"x88 5/8"	100128267 L167901793	G-121	12 x Cj 696 x Pal	2,16 x Cj 125,28 x Pal	19,45 x Cj 1128,22 x Pal
Adh Profile / Perfil Adh / Profilé Adh	3,5x270cm 1 3/8"x106 1/4"	100177547 L167012727	G-155	20 x Cj 1000 x Pal	2,16 x Cj 108,00 x Pal	15,92 x Cj 796 x Pal
Aluminium Linkfloor Adh Profile / Perfil Adh Linkfloor Aluminio / Profilé Adh Linkfloor Aluminium	3,5x270cm 1 3/8"x106 1/4"	100174756 L167012669	G-121	10 x Cj 1000 x Pal	0,95 x Cj 94,50 x Pal	3,87 x Cj 387 x Pal



Linkfloor Oak Natural



Description	Format	Codes	Group	Pcs	m2	Kg
Linkfloor Oak Natural	30,5x123x0,55cm 12"x48 3/8"x1/4"	100126718 L167012140	G-252	8 x Cj 408 x Pal	3,01 x Cj 153,06 x Pal	21,73 x Cj 1108,13 x Pal
Skirting / Zócalo / Plinthe	8x220 3 1/8"x86 5/8"	100177558 L167012735	G-121	14 x Cj 560 x Pal	2,46 x Cj 98,56 x Pal	19,32 x Cj 772,80 x Pal
Aluminium Skirting / Zócalo Aluminio / Plinthe Aluminium	8x225cm 3 1/8"x88 5/8"	100128267 L167901793	G-121	12 x Cj 696 x Pal	2,16 x Cj 125,28 x Pal	19,45 x Cj 1128,22 x Pal
Adh Profile / Perfil Adh / Profilé Adh	3,5x270cm 1 3/8"x106 1/4"	100177548 L167012724	G-155	20 x Cj 1000 x Pal	2,16 x Cj 108,00 x Pal	15,92 x Cj 796 x Pal
Aluminium Linkfloor Adh Profile / Perfil Adh Linkfloor Aluminio / Profilé Adh Linkfloor Aluminium	3,5x270cm 1 3/8"x106 1/4"	100174756 L167012669	G-121	10 x Cj 1000 x Pal	0,95 x Cj 94,50 x Pal	3,87 x Cj 387 x Pal

STOCK

Oak



Linkfloor Oak Grey



NATURAL



WET



FLOATING
INSTALLATION



RADIANT
FLOOR
HEATING



LOCK



WARRANTY



ANTI-STATIC
FLOOR

Description	Format	Codes	Group	Pcs	m2	Kg
Linkfloor Oak Grey	30,5x123x0,55cm 12"x48 3/8"x1/4"	100126717 L167012134	G-252	8 x Cj 408 x Pal	3,01 x Cj 153,06 x Pal	21,73 x Cj 1108,13 x Pal
Skirting / Zócalo / Plinthe	8x220 3 1/18"x86 5/8"	100177563 L167012734	G-121	14 x Cj 560 x Pal	2,46 x Cj 98,56 x Pal	19,32 x Cj 772,80 x Pal
Aluminium Skirting / Zócalo Aluminio / Plinthe Aluminium	8x225cm 3 1/8"x88 5/8"	100128267 L167901793	G-121	12 x Cj 696 x Pal	2,16 x Cj 125,28 x Pal	19,45 x Cj 1128,22 x Pal
Adh Profile / Perfil Adh / Profilé Adh	3,5x270cm 1 3/8"x106 1/4"	100177528 L167012723	G-155	20 x Cj 1000 x Pal	2,16 x Cj 108,00 x Pal	15,92 x Cj 796 x Pal
Aluminium Linkfloor Adh Profile / Perfil Adh Linkfloor Aluminio / Profilé Adh Linkfloor Aluminium	3,5x270cm 1 3/8"x106 1/4"	100174756 L167012669	G-121	10 x Cj 1000 x Pal	0,95 x Cj 94,50 x Pal	3,87 x Cj 387 x Pal

STOCK



Linkfloor Oak White



NATURAL



WET



FLOATING
INSTALLATION



RADIANT
FLOOR
HEATING



LOCK



WARRANTY



ANTI-STATIC
FLOOR

Description	Format	Codes	Group	Pcs	m2	Kg
Linkfloor Oak White	30,5x123x0,55cm 12"x48 3/8"x1/4"	100126719 L167012142	G-252	8 x Cj 408 x Pal	3,01 x Cj 153,06 x Pal	21,73 x Cj 1108,13 x Pal
Skirting / Zócalo / Plinthe	8x220 3 1/18"x86 5/8"	100177574 L167012733	G-121	14 x Cj 560 x Pal	2,46 x Cj 98,56 x Pal	19,32 x Cj 772,80 x Pal
Aluminium Skirting / Zócalo Aluminio / Plinthe Aluminium	8x225cm 3 1/8"x88 5/8"	100128267 L167901793	G-121	12 x Cj 696 x Pal	2,16 x Cj 125,28 x Pal	19,45 x Cj 1128,22 x Pal
Adh Profile / Perfil Adh / Profilé Adh	3,5x270cm 1 3/8"x106 1/4"	100177529 L167012725	G-155	20 x Cj 1000 x Pal	2,16 x Cj 108,00 x Pal	15,92 x Cj 796 x Pal
Aluminium Linkfloor Adh Profile / Perfil Adh Linkfloor Aluminio / Profilé Adh Linkfloor Aluminium	3,5x270cm 1 3/8"x106 1/4"	100174756 L167012669	G-121	10 x Cj 1000 x Pal	0,95 x Cj 94,50 x Pal	3,87 x Cj 387 x Pal

BEFORE INSTALLING

ANTES DE LA INSTALACIÓN

AVANT DE COMMENCER LA POSE

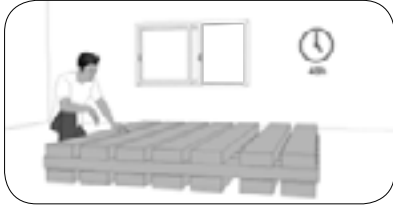

The material must be climatized to the temperature of the setting where it will be installed for 48h beforehand.

Material acondicionado a temperatura del entorno donde se va a instalar durante las 48h previas.

Matériel aménagé à la température de l'endroit où il sera installé au cours des 48h préalables.



Optimal conditions: Temp. 20-23°C/65-80°F and 40-60% relative humidity.

Condiciones óptimas 20-23°C/65-80°F y 40-60% de humedad.

Conditions optimales : 20-23°C/65-80°F et 40-60% d'humidité.



Open several packages and mix pieces before installing.

Abrir varios paquetes y mezclar piezas antes de la instalación.

Ouvrir les paquets et mélanger les pièces avant l'installation.



Dry and moisture-free, compact and resistant, clean and dust-free surface.

Superficie seca y sin humedad, compacta y resistente, limpia y sin polvo.

La surface doit être sèche et sans humidité, compacte et résistante, propre et sans poussière.

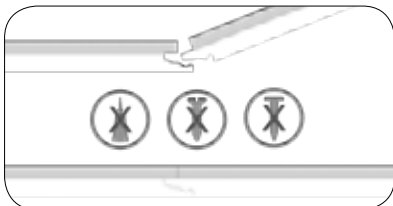

Do not set the anchors with nails, screws, or glues.

No fijar los anclajes con clavos, tornillos o colas.

Ne pas fixer les ancrages avec des clous, des vis ou de la colle.

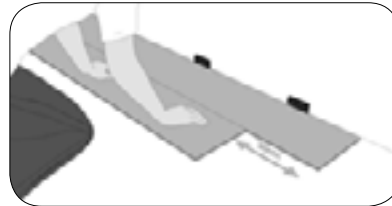

Stagger from the joint, no less than 30cm between pieces.

Escalonar desde la junta, distancias no inferiores de 30cm entre piezas.

Échelonner à partir du joint, la distance entre les pièces ne doit pas être inférieure à 30cm.

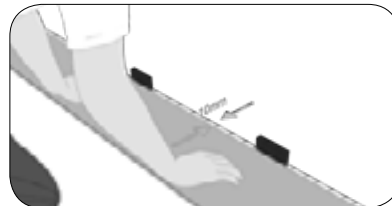

Keep a distance of 1 cm to all structural elements from all perimeter edges (in the case of semi-open spaces leave a larger perimeter separation, 0.5mm per linear meter of the area where the floor is being installed.)

Expansion joints in all the door thresholds and mandatorily every 8m lengthwise and/or cross-wise.

Mantener distancia de 1cm a todos los elementos estructurales desde todos los bordes del perímetro (en espacios semiabierto dejar mayor separación perimetral: 0,5mm por metro lineal de la zona donde se instale el suelo).

Juntas de dilatación en todos los pasos de puerta y obligatoriamente cada 8m en sentido longitudinal y/o transversal.

Conserver une distance de 1 cm de tous les éléments structurels depuis tous les bords du périmètre (dans des espaces semi-ouverts, laisser une séparation périmétrale plus grande: 0,5mm par mètre linéaire de la zone où le revêtement sera mis en place).

Joints de dilatation sur tous les passages de porte et obligatoirement tous les 8m en sens longitudinal et/ou transversal.

INSTALLATION

INSTALACIÓN

POSE

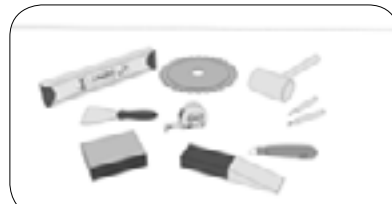

Tools: tape measure, pencil, saw, hammer, sealant, level, spacer wedges, and if possible, a padfoot, and a nylon stud.

Herramientas: cinta métrica, lápiz, sierra, martillo, sellador, nivel, cuñas espaciadoras y, si es posible, una pata de cabra y taco de nylon.

Outils: mètre, crayon, scie, marteau, appareil à souder, niveau, cales et, si c'est possible, pied de biche et cheville en nylon.



We recommend installing the L'Antic Colonial sheet, whether it is the moisture barrier+foam sheet or the antistatic radiant-floor film.

Se recomienda la instalación de la lámina de L' Antic Colonial. Ya sea la lámina anti-humedad+espuma o la de suelo radiante antiestática.

Il est recommandé d'installer la lame de L'Antic Colonial. Soit la lame anti-humidité+mousse, soit la lame de plancher rayonnant anti-statique.

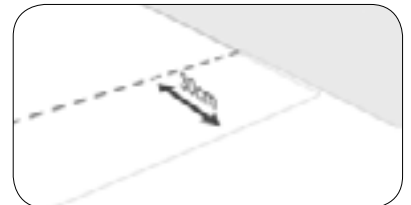

Overlap the film about 30cm.

Solapar el film unos 30cm.

Chevaucher le film environ 30cm.



Always install the material floating, without glue below the surface.

Colocar el material de manera flotante, sin pegamento debajo de la superficie.

Poser le matériel en flottaison et sans colle sous la surface.



Positioned the pieces longitudinally with respect to the light entrance whenever possible.

Posicionar las piezas longitudinalmente respecto a la entrada de luz, siempre que sea posible.

Placer les pièces longitudinalement par rapport à l'entrée de lumière, lorsque cela est possible.

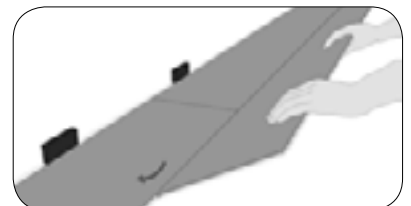

After having aligned the first row with the help of a level, install the second one using the left-over piece.

Tras haber alineado la primera fila con

Installation / Instalación / Installation

la ayuda de un nivel, colocar la segunda, usando la pieza sobrante.

Après avoir aligné la première file à l'aide d'un niveau, placer la deuxième en utilisant la pièce en trop.

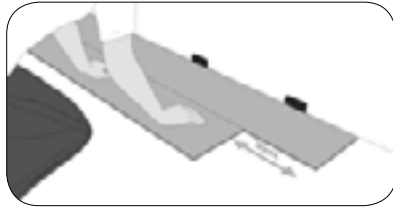

The piece joints between 2 rows shall be at least about 30cm apart.

Las juntas de las piezas entre 2 filas deben distar unos 30cm como mínimo.

Les joints des pièces entre deux files doivent être à une distance minimale de 30cm.

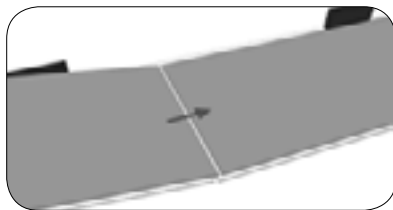

Install the first piece slightly diagonally, tighten, and gently swing. Proceed the same way with the second board, and position the head in front of the previous piece.

Instalar la primera pieza ligeramente en diagonal, apretar y balancear suavemente. Proceder de la misma forma con la segunda tabla, y posicionar la cabeza en frente de la pieza anterior.

Installer la première pièce légèrement en diagonale, serrer puis balancer doucement. Installer la deuxième planche de la même manière et placer la tête face à la pièce précédente.

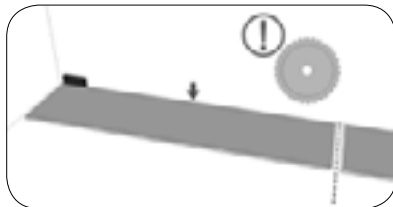

Cut the piece needed to complete the first row of the shortest wall of the room where it is being installed.

Cortar la pieza, necesaria para completar la primera fila, en la pared más corta de la habitación.

Couper la pièce, nécessaire pour compléter la première file, sur la cloison plus courte de la chambre.

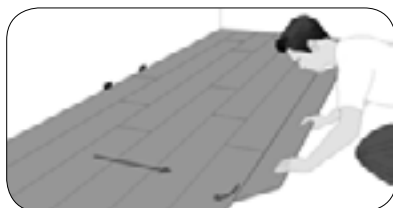

Join the pieces laterally with a 45° movement, until you feel the closing click, aligning with the wedges from the wall. The distance to the wall shall be at least 1cm.

Juntar las piezas lateralmente con un movimiento de 45°, hasta notar el cierre del clic, alineando con las cuñas desde la pared.

Distancia hasta la pared de 1cm como mínimo.

Unir las piezas lateralmente con un movimiento de 45°, jusqu'à entendre la fermeture du clic, en les alignant avec les cales à partir du mur. Distance minimale jusqu'au mur: 1cm.



Remove the spacer wedges after finishing the installation.

Retirar las cuñas espaciadoras después de completar la instalación.

Enlever les cales après la mise en place de l'installation.



Cut the doors moldings at floor height, and when installing the plank that goes under the moldings, measure the distance to the wall and give it at least 10mm of space.

Cortar las tapetas de las puertas, a la altura del suelo, y al instalar la tabla que va bajo las tapetas, medir la distancia hasta la pared y darle los 10mm mínimos de espacio.

Couper les couvre-joints des portes, à la hauteur du sol. Lors de l'installation de la planche qui va sous les couvre-joints, mesurer la distance jusqu'au mur et ajouter les 10mm minimaux d'espace.



Place a rug under tables and chairs... In case of heavy furniture, do not drag them directly on the installed floor.

Poner una alfombra bajo las mesas y sillas, etc... En caso de posicionar muebles pesados, no arrastarlos directamente sobre el suelo instalado.

Mettre un tapis sous les tables et les chaises, etc. S'il faut placer des meubles lourds, ne pas les déplacer directement sur le plancher posé.

RADIANT FLOOR HEATING
CALEFACCIÓN RADIANTE
CHAUFFAGE RADIANT



Activate to 25-30°C during the 10 days

prior to the installation. We recommend installing the L'Antic Colonial antistatic radiant-floor film.

Activar a 25-30°C durante los 10 días previos a la instalación. Recomendamos colocar la Lámina para Suelo Radiante Antiestática de L'Antic Colonial.

Activer la température à 25-30°C pendant les dix jours préalables à la pose. Il est recommandé d'installer la lame pour plancher rayonnant anti-statique de L'Antic Colonial.



After installing turn the heating on gradually, increasing the temperature by 2-3°C each day, up to about 28°C.

Tras las instalación, encender la calefacción gradualmente, incrementando la temperatura 2-3°C cada día, hasta unos 28°C.

Après la pose, allumer le chauffage graduellement, en augmentant la température entre 2 et 3°C chaque jour jusqu'à atteindre environ 28°C.



Keep at least one day per cm of thickness of the sub-base, and keep overnight.

Mantener como mínimo un día por cada cm de espesor del subsuelo, y mantener durante toda la noche.

Maintenir la température au moins un jour pour chaque centimètre d'épaisseur du sous-sol pendant toute la nuit.



Next, the temperature must be lowered 2-3°C daily until the floor reaches 15°C (about 10 days.)

A continuación, disminuir la temperatura 2-3°C diarios hasta que el suelo alcance los 15°C (unos 10 días).

Ensuite, diminuer la température entre 2 et 3°C jusqu'à ce que la température du sol arrive à 15°C (environ 10 jours).

You can see these updated installation instructions by visiting our website www.anticcolonial.com

Puedes revisar estas instrucciones de instalación actualizadas y con más detalle visitando nuestra página web www.anticcolonial.com

Pour réviser ces instructions d'installation, mises à jour et plus détaillées, veuillez visiter notre site Internet www.anticcolonial.com





Hotel Air

—
Walnut
Ash
Earth
Mist
Silver
Maple



Floor Coverings Linkfloor Hotel Air Earth



Floor Coverings Linkfloor Hotel Air Mist / Wall Coverings Capadoccia Sand Home, Diverse Grey / Complementary Products Essence Habana Dark Classico





Linkfloor Hotel Air Walnut



LIFE



WET

FLOATING
INSTALLATIONRADIANT
FLOOR
HEATING

LOCK



WARRANTY

ANTI-STATIC
FLOOR

Description	Format	Codes	Group	Pcs	m2	Kg
Linkfloor Hotel Air Walnut	17,78x121,92x0,5cm 7"x48"x1/4"	100193317 L167012866	G-228	8 x Cj 352 x Pal	1,73 x Cj 76,30 x Pal	18,80 x Cj 827,20 x Pal
Skirting / Zócalo / Plinthe	8x220x1,5cm 3 1/8"x86 5/8"x5/8"	100177482 L167012719	G-121	14 x Cj 560 x Pal	2,46 x Cj 98,56 x Pal	19,32 x Cj 772,80 x Pal
Aluminium Skirting / Zócalo Aluminio / Plinthe Aluminium	8x225cm 3 1/8"x88 5/8"	100128267 L167901793	G-121	12 x Cj 696 x Pal	2,16 x Cj 125,28 x Pal	19,45 x Cj 1128,22 x Pal
Adh Profile / Perfil Adh / Profilé Adh	3,5x270cm 1 3/8"x106 1/4"	100177438 L167012714	G-155	20 x Cj 1000 x Pal	2,16 x Cj 108,00 x Pal	15,92 x Cj 796 x Pal
Aluminium Linkfloor Adh Profile / Perfil Adh Linkfloor Aluminio / Profilé Adh Linkfloor Aluminium	3,5x270cm 1 3/8"x106 1/4"	100174756 L167012669	G-121	10 x Cj 1000 x Pal	0,95 x Cj 94,50 x Pal	3,87 x Cj 387 x Pal

STOCK

*L'Antic Colonial recommends using the anti-static, heat-diffusing membrane with Linkfloor Hotel Air.

En la instalación de Linkfloor Hotel Air, L'Antic Colonial recomienda el uso de la Lámina Suelo Radiante Antiestática.

Lors de l'installation de Linkfloor Hotel Air, L'Antic Colonial recommande l'utilisation de la membrane antistatique pour planche rayonnant.



Linkfloor Hotel Air Ash



LIFE



WET

FLOATING
INSTALLATIONRADIANT
FLOOR
HEATING

LOCK



WARRANTY

ANTI-STATIC
FLOOR

Description	Format	Codes	Group	Pcs	m2	Kg
Linkfloor Hotel Air Ash	17,78x121,92x0,5cm 7"x48"x1/4"	100193262 L167012861	G-228	8 x Cj 352 x Pal	1,73 x Cj 76,30 x Pal	18,80 x Cj 827,20 x Pal
Skirting / Zócalo / Plinthe	8x220x1,5cm 3 1/8"x86 5/8"x5/8"	100177475 L167012717	G-121	14 x Cj 560 x Pal	2,46 x Cj 98,56 x Pal	19,32 x Cj 772,80 x Pal
Aluminium Skirting / Zócalo Aluminio / Plinthe Aluminium	8x225cm 3 1/8"x88 5/8"	100128267 L167901793	G-121	12 x Cj 696 x Pal	2,16 x Cj 125,28 x Pal	19,45 x Cj 1128,22 x Pal
Adh Profile / Perfil Adh / Profilé Adh	3,5x270cm 1 3/8"x106 1/4"	100177467 L167012713	G-155	20 x Cj 1000 x Pal	2,16 x Cj 108,00 x Pal	15,92 x Cj 796 x Pal
Aluminium Linkfloor Adh Profile / Perfil Adh Linkfloor Aluminio / Profilé Adh Linkfloor Aluminium	3,5x270cm 1 3/8"x106 1/4"	100174756 L167012669	G-121	10 x Cj 1000 x Pal	0,95 x Cj 94,50 x Pal	3,87 x Cj 387 x Pal

STOCK

*L'Antic Colonial recommends using the anti-static, heat-diffusing membrane with Linkfloor Hotel Air.

En la instalación de Linkfloor Hotel Air, L'Antic Colonial recomienda el uso de la Lámina Suelo Radiante Antiestática.

Lors de l'installation de Linkfloor Hotel Air, L'Antic Colonial recommande l'utilisation de la membrane antistatique pour planche rayonnant.

Hotel Air



Linkfloor Hotel Air Earth



Description	Format	Codes	Group	Pcs	m2	Kg
Linkfloor Hotel Air Earth	17,78x121,92x0,5cm 7"x48"x1/4"	100193291 L167012862	G-228	8 x Cj 352 x Pal	1,73 x Cj 76,30 x Pal	18,80 x Cj 827,20 x Pal
Skirting / Zócalo / Plinthe	8x220x1,5cm 3 1/8"x86 5/8"x5/8"	100177439 L167012710	G-121	14 x Cj 560 x Pal	2,46 x Cj 98,56 x Pal	19,32 x Cj 772,80 x Pal
Aluminium Skirting / Zócalo Aluminio / Plinthe Aluminium	8x225cm 3 1/8"x88 5/8"	100128267 L167901793	G-121	12 x Cj 696 x Pal	2,16 x Cj 125,28 x Pal	19,45 x Cj 1128,22 x Pal
Adh Profile / Perfil Adh / Profilé Adh	3,5x270cm 1 3/8"x106 1/4"	100177473 L167012721	G-155	20 x Cj 1000 x Pal	2,16 x Cj 108,00 x Pal	15,92 x Cj 796 x Pal
Aluminium Linkfloor Adh Profile / Perfil Adh Linkfloor Aluminio / Profilé Adh Linkfloor Aluminium	3,5x270cm 1 3/8"x106 1/4"	100174756 L167012669	G-121	10 x Cj 1000 x Pal	0,95 x Cj 94,50 x Pal	3,87 x Cj 387 x Pal

STOCK

*L'Antic Colonial recommends using the anti-static, heat-diffusing membrane with Linkfloor Hotel Air.

En la instalación de Linkfloor Hotel Air, L'Antic Colonial recomienda el uso de la Lámina Suelo Radiante Antiestática.

Lors de l'installation de Linkfloor Hotel Air, L'Antic Colonial recommande l'utilisation de la membrane antistatique pour planche rayonnant.



Linkfloor Hotel Air Mist



Description	Format	Codes	Group	Pcs	m2	Kg
Linkfloor Hotel Air Mist	17,78x121,92x0,5cm 7"x48"x1/4"	100193242 L167012860	G-228	8 x Cj 352 x Pal	1,73 x Cj 76,30 x Pal	18,80 x Cj 827,20 x Pal
Skirting / Zócalo / Plinthe	8x220x1,5cm 3 1/8"x86 5/8"x5/8"	100177490 L167012708	G-121	14 x Cj 560 x Pal	2,46 x Cj 98,56 x Pal	19,32 x Cj 772,80 x Pal
Aluminium Skirting / Zócalo Aluminio / Plinthe Aluminium	8x225cm 3 1/8"x88 5/8"	100128267 L167901793	G-121	12 x Cj 696 x Pal	2,16 x Cj 125,28 x Pal	19,45 x Cj 1128,22 x Pal
Adh Profile / Perfil Adh / Profilé Adh	3,5x270cm 1 3/8"x106 1/4"	100177459 L167012712	G-155	20 x Cj 1000 x Pal	2,16 x Cj 108,00 x Pal	15,92 x Cj 796 x Pal
Aluminium Linkfloor Adh Profile / Perfil Adh Linkfloor Aluminio / Profilé Adh Linkfloor Aluminium	3,5x270cm 1 3/8"x106 1/4"	100174756 L167012669	G-121	10 x Cj 1000 x Pal	0,95 x Cj 94,50 x Pal	3,87 x Cj 387 x Pal

STOCK

*L'Antic Colonial recommends using the anti-static, heat-diffusing membrane with Linkfloor Hotel Air.

En la instalación de Linkfloor Hotel Air, L'Antic Colonial recomienda el uso de la Lámina Suelo Radiante Antiestática.

Lors de l'installation de Linkfloor Hotel Air, L'Antic Colonial recommande l'utilisation de la membrane antistatique pour planche rayonnant.



Linkfloor Hotel Air Silver



LIFE



WET

FLOATING
INSTALLATIONRADIANT
FLOOR
HEATING

LOCK



WARRANTY

ANTI-STATIC
FLOOR

Description	Format	Codes	Group	Pcs	m2	Kg
Linkfloor Hotel Air Silver	17,78x121,92x0,5cm 7"x48"x1/4"	100193326 L167012864	G-228	8 x Cj 352 x Pal	1,73 x Cj 76,30 x Pal	18,80 x Cj 827,20 x Pal
Skirting / Zócalo / Plinthe	8x220x1,5cm 3 1/8"x86 5/8"x5/8"	100177481 L167012716	G-121	14 x Cj 560 x Pal	2,46 x Cj 98,56 x Pal	19,32 x Cj 772,80 x Pal
Aluminium Skirting / Zócalo Aluminio / Plinthe Aluminium	8x225cm 3 1/8"x88 5/8"	100128267 L167901793	G-121	12 x Cj 696 x Pal	2,16 x Cj 125,28 x Pal	19,45 x Cj 1128,22 x Pal
Adh Profile / Perfil Adh / Profilé Adh	3,5x270cm 1 3/8"x106 1/4"	100177437 L167012718	G-155	20 x Cj 1000 x Pal	2,16 x Cj 108,00 x Pal	15,92 x Cj 796 x Pal
Aluminium Linkfloor Adh Profile / Perfil Adh Linkfloor Aluminio / Profilé Adh Linkfloor Aluminium	3,5x270cm 1 3/8"x106 1/4"	100174756 L167012669	G-121	10 x Cj 1000 x Pal	0,95 x Cj 94,50 x Pal	3,87 x Cj 387 x Pal

STOCK

*L'Antic Colonial recommends using the anti-static, heat-diffusing membrane with Linkfloor Hotel Air.

En la instalación de Linkfloor Hotel Air, L'Antic Colonial recomienda el uso de la Lámina Suelo Radiante Antiestática.

Lors de l'installation de Linkfloor Hotel Air, L'Antic Colonial recommande l'utilisation de la membrane antistatique pour planche rayonnant.



Linkfloor Hotel Air Maple



LIFE



WET

FLOATING
INSTALLATIONRADIANT
FLOOR
HEATING

LOCK



WARRANTY

ANTI-STATIC
FLOOR

Description	Format	Codes	Group	Pcs	m2	Kg
Linkfloor Hotel Air Maple	17,78x121,92x0,5cm 7"x48"x1/4"	100193286 L167012863	G-228	8 x Cj 352 x Pal	1,73 x Cj 76,30 x Pal	18,80 x Cj 827,20 x Pal
Skirting / Zócalo / Plinthe	8x220x1,5cm 3 1/8"x86 5/8"x5/8"	100177480 L167012720	G-121	14 x Cj 560 x Pal	2,46 x Cj 98,56 x Pal	19,32 x Cj 772,80 x Pal
Aluminium Skirting / Zócalo Aluminio / Plinthe Aluminium	8x225cm 3 1/8"x88 5/8"	100128267 L167901793	G-121	12 x Cj 696 x Pal	2,16 x Cj 125,28 x Pal	19,45 x Cj 1128,22 x Pal
Adh Profile / Perfil Adh / Profilé Adh	3,5x270cm 1 3/8"x106 1/4"	100177436 L167012709	G-155	20 x Cj 1000 x Pal	2,16 x Cj 108,00 x Pal	15,92 x Cj 796 x Pal
Aluminium Linkfloor Adh Profile / Perfil Adh Linkfloor Aluminio / Profilé Adh Linkfloor Aluminium	3,5x270cm 1 3/8"x106 1/4"	100174756 L167012669	G-121	10 x Cj 1000 x Pal	0,95 x Cj 94,50 x Pal	3,87 x Cj 387 x Pal

*L'Antic Colonial recommends using the anti-static, heat-diffusing membrane with Linkfloor Hotel Air.

En la instalación de Linkfloor Hotel Air, L'Antic Colonial recomienda el uso de la Lámina Suelo Radiante Antiestática.

Lors de l'installation de Linkfloor Hotel Air, L'Antic Colonial recommande l'utilisation de la membrane antistatique pour planche rayonnant.



BEFORE INSTALLING

ANTES DE INSTALAR

AVANT DE COMMENCER LA POSE



Receiving and storage: verify the material and the installation location.

Recepción y almacenaje: verificar el material y el lugar de la instalación.

Réception et stockage : vérifier le matériel et le lieu de l'installation.

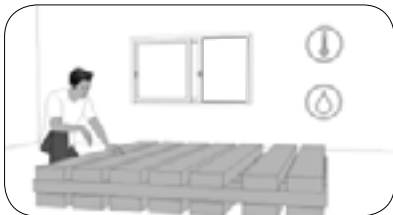

Climatic conditions: Temp. 20-23°C/65-80°F; 40-60% relative humidity.

Condiciones climáticas: Tª 20-23°C/65-80°F; Humedad relativa 40-60%.

Conditions climatiques: Température: 20-23°C/65-80°F; humidité relative: 40-60%.

Substrates

Subsuelo

Sous-couches



Measure humidity with a hygrometer. Max 2.5%

Medir la humedad con higrómetro. Max 2,5%.

Mesurer l'humidité avec un hygromètre. Max 2,5%.

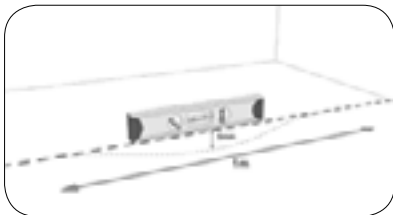

Flatness and horizontality: max. 5mm and 1mm. Measured with 2m rulers and approx. 20cm.

Planimetría y horizontalidad: max. 5mm y 1mm. Medidas con reglas de 2 y 20cm aprox.

Planimétrie et horizontalité : maximum

5mm et 1mm. Mesures avec des règles d'environ 2 et 20cm.



Cleaning: clean base slab, and free from elements.

Limpieza: solera limpia y libre de elementos.

Nettoyage lisse de terre propre et dépourvue d'éléments.



Install boards in parallel to the main light source in the room. If this is not possible, to the longer wall.

Instalar tablas en paralelo a la fuente de luz principal de la habitación. Si esto no es posible a la pared más larga.

Installer les planches parallèles à la source de lumière principale de la pièce. Si cela n'est pas possible, le faire au mur plus long.

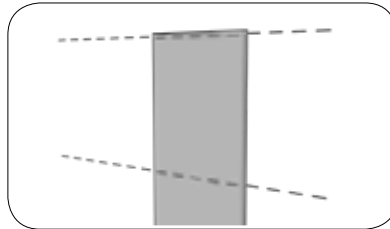

Measure out whether the boards in the first row need to be cut widthwise. If not required, trim the tongue so that the wall end is smooth.

Medir tablas de la primera fila por si tienen que cortarse a lo ancho. Si no fuese necesario, recortar la lengüeta para que el de la pared sea liso.

Mesurer les planches de la première file, pour vérifier s'il faut les couper en largeur. Si ce n'était pas nécessaire, découper la languette pour que celle du mur soit lisse.

INSTALLATION

INSTALACIÓN

POSE

Floating system

Sistema flotante

Système flottant

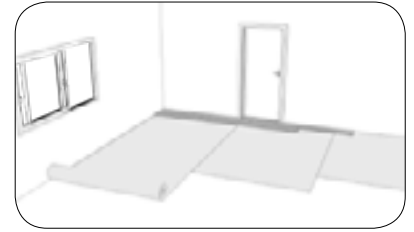

We recommend installing the L'Antic Colonial sheet, whether it is the moisture barrier+foam sheet or the antistatic radiant-floor film.

Se recomienda instalar la lámina de L'Antic Colonial. Ya sea la lámina anti-humedad + espuma o la de suelo radiante antiestática.

Il est recommandé d'installer la lame de L'Antic Colonial. Soit la lame anti-humidité + mousse, soit la lame de plancher rayonnant anti-statique.

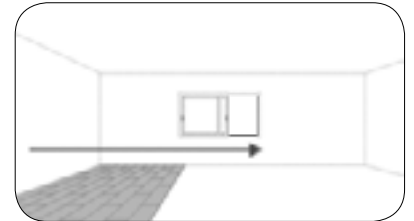

Install the boards from left to right.

Instalar las tablas desde la izquierda hacia la derecha.

Installer les planches de gauche à droite.

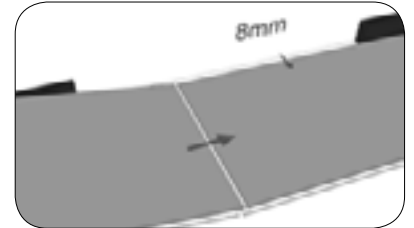

Install the second board of the first row by wrapping the short tongue in the short groove of the first board. Do not bend the board corners. Expansion gap of 8mm more or less between the board and wall.

Instalar la segunda tabla de la primera fila envolviendo la lengüeta corta en la ranura corta de la primera. No doblar las esquinas de la tabla. Ranura de expansión de unos 8mm entre tabla y pared.

Installer la deuxième planche de la première file en enveloppant la languette courte dans la rainure courte de la première planche. Ne pliez pas les coins de la planche. Rainure de dilatation d'environ 8mm entre la planche et le mur.

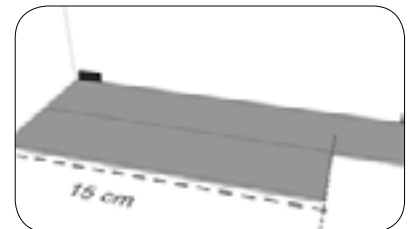

Installation / Instalación / Installation

Start the second row by cutting one board to the desired length. 15cm board minimum.

Comenzar la segunda fila recortando una tabla a la medida deseada. Mínimo de la tabla 15cm.

Commencer la deuxième file en découpant une planche à la mesure souhaitée. La planche doit mesurer minimum 15cm.

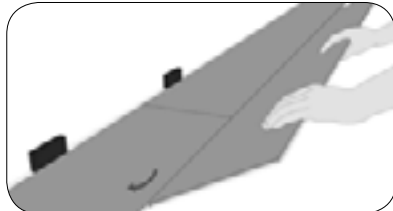

In the second row, install the first board by wrapping the long tongue with the groove of the board from the first row at a small angle. Install the second board by joining the short tongue with the groove of the previously-installed board. Adjust the board so that the side of the long tongue is positioned over the groove of the board in the first row. Start from the last fitting, insert the long tongue in the groove of the opposite board.

En la segunda fila, instalar la primera tabla envolviendo la lengüeta larga con la ranura de la tabla de la primera fila en un ángulo pequeño. Colocar la segunda tabla uniendo la lengüeta corta con la ranura de la tabla instalada anteriormente. Ajustar la tabla de forma que el lado de la lengüeta larga esté posicionado por encima de la ranura de la tabla de la primera fila. Comenzar desde el encaje final, introducir la lengüeta larga en la ranura de la tabla de enfrente.

Dans la deuxième file, installer la première planche en enveloppant la languette longue avec la rainure de la planche de la première file dans l'angle petit. Placer la deuxième planche en unissant la languette courte avec la rainure de la planche préalablement installée. Ajuster la planche de façon à ce que la languette longue soit située au-dessus de la rainure de la planche de la première file. Commencer depuis l'emboîtement final, introduire la languette longue dans la rainure de la planche d'en face.

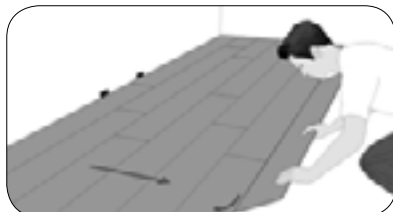

Install the remaining first and second row boards as described in the previous points.

Instalar las tablas restantes de la primera y segunda fila como se describe en los puntos anteriores.

Installer les planches restantes de la première et la deuxième file en suivant les descriptions ci-dessus.

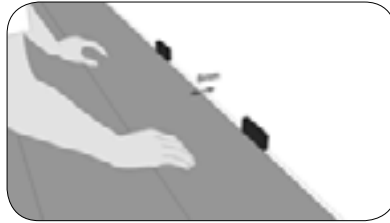

Install the last board in the first row, leaving space to the wall for an expansion gap of about 8mm.

Instalar la última tabla de la primera fila dejando espacio con la pared para una ranura de expansión de unos 8mm.

Installer la dernière planche de la première file en laissant un espace avec le mur pour une rainure de dilatation d'environ 8 mm.



Heavy furniture can deform the surface of the pieces

El mobiliario pesado puede deformar la superficie de las piezas.

Le mobilier lourd peut déformer la surface des pièces.

Radiant floor heating

Suelo radiante

Plancher rayonnant

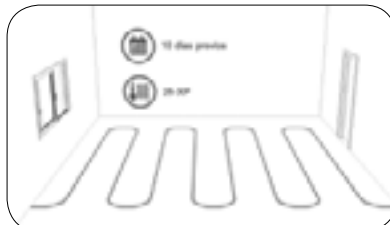

Turn on the radiant system to 25-30°C, 10 days before installing.

Encender el sistema radiante 10 días antes de la instalación a 25-30°C.

Allumer le système de chauffage rayonnant 10 jours avant l'installation à 25-30°C.

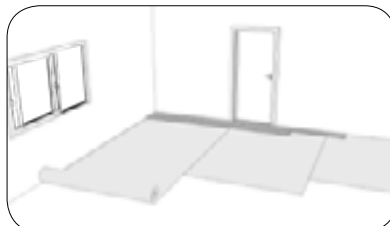

We recommend installing the L'Antic Colonial antistatic radiant-floor film.

Se recomienda instalar la lámina para suelo radiante antiestática de L'Antic Colonial.

Il est recommandé d'installer la lame pour plancher rayonnant anti-statique de L'Antic Colonial.



Once installed, increase the temperature by 2-3°C per day until reaching 27-28°C.

Una vez instalado incrementar la Tº 2- 3°C al día hasta 27-28°C.

Après l'installation du revêtement pour le sol, augmenter la température entre 2 et 3°C chaque jour jusqu'à 27-28°C.



Once the max temperature is reached (27-28°C,) it must be maintained one day per cm of thickness of the sub-floor (overnight).

Una vez alcanzada la Tº max (27-28°C). Mantener un día por cada cm de espesor del subsuelo (por la noche).

Dès que la température maximale (27-28°C) est atteinte, la maintenir un jour pour chaque centimètre d'épaisseur du sous-sol (pendant toute la nuit).



The temperature must be lowered 2-3°C until the floor reaches 15°C (about 10 days.)

The Hotel Air series is suitable for glued installation.

Disminuir la Tº 2-3°C hasta que el suelo alcance los 15°C (unos 10 días).

La serie Hotel Air es apta para la instalación encolada.

Finalmente, disminuir la température entre 2 et 3°C jusqu'à ce que la température du sol arrive à 15°C (environ 10 jours).

La série Hotel Air est adéquate pour l'installation encollée.

You can see these updated installation instructions by visiting our website www.anticcolonial.com

Puedes revisar estas instrucciones de instalación actualizadas y con más detalle visitando nuestra página web www.anticcolonial.com

Pour réviser ces instructions d'installation, mises à jour et plus détaillées, veuillez visiter notre site Internet www.anticcolonial.com



Empire



- Brown
- Cream
- Light Grey
- Tan





**Linkfloor Empire
Brown**



Description	Format	Codes	Group	Pcs	m2	Kg
Linkfloor Empire Brown	22,8x180x0,75cm 9"x70 7/8"x1/4"	100203343 L165003951	G-230	4 x Cj 256 x Pal	1,64 x Cj 105,06 x Pal	13,66 x Cj 874,24 x Pal
Zocalo Linkfloor Empire Brown	8x220x1,5cm 3 1/8"x86 5/8"x5/8"	100211773 L167012927	G-121	14 x Cj 560 x Pal	2,46 x Cj 98,56 x Pal	19,32 x Cj 772,80 x Pal
Aluminium Skirting / Zócalo Aluminio / Plinthe Aluminium	8x225cm 3 1/8"x88 5/8"	100128267 L167901793	G-121	12 x Cj 696 x Pal	2,16 x Cj 125,28 x Pal	19,45 x Cj 1128,22 x Pal
Adh Profile / Perfil Adh / Profilé Adh	3,5x270cm 1 3/8"x106 1/4"	100211782 L167012928	G-155	20 x Cj 1000 x Pal	2,16 x Cj 108,00 x Pal	15,92 x Cj 796 x Pal
Aluminium Linkfloor Adh Profile / Perfil Adh Linkfloor Aluminio / Profilé Adh Linkfloor Aluminium	3,5x270cm 1 3/8"x106 1/4"	100174756 L167012669	G-121	10 x Cj 1000 x Pal	0,95 x Cj 94,50 x Pal	3,87 x Cj 387 x Pal

NEW



**Linkfloor Empire
Cream**



Description	Format	Codes	Group	Pcs	m2	Kg
Linkfloor Empire Cream	22,8x180x0,75cm 9"x70 7/8"x1/4"	100203327 L165003954	G-230	4 x Cj 256 x Pal	1,64 x Cj 105,06 x Pal	13,66 x Cj 874,24 x Pal
Zocalo Linkfloor Empire Cream	8x220x1,5cm 3 1/8"x86 5/8"x5/8"	100211774 L167012921	G-121	14 x Cj 560 x Pal	2,46 x Cj 98,56 x Pal	19,32 x Cj 772,80 x Pal
Aluminium Skirting / Zócalo Aluminio / Plinthe Aluminium	8x225cm 3 1/8"x88 5/8"	100128267 L167901793	G-121	12 x Cj 696 x Pal	2,16 x Cj 125,28 x Pal	19,45 x Cj 1128,22 x Pal
Adh Profile / Perfil Adh / Profilé Adh	3,5x270cm 1 3/8"x106 1/4"	100211756 L167012924	G-155	20 x Cj 1000 x Pal	2,16 x Cj 108,00 x Pal	15,92 x Cj 796 x Pal
Aluminium Linkfloor Adh Profile / Perfil Adh Linkfloor Aluminio / Profilé Adh Linkfloor Aluminium	3,5x270cm 1 3/8"x106 1/4"	100174756 L167012669	G-121	10 x Cj 1000 x Pal	0,95 x Cj 94,50 x Pal	3,87 x Cj 387 x Pal

NEW

Empire



Linkfloor Empire Light Grey



NATURAL



WET



FLOATING
INSTALLATION



RADIANT
FLOOR
HEATING



LOCK



15
WARRANTY

Description	Format	Codes	Group	Pcs	m2	Kg
Linkfloor Empire Light Grey	22,8x180x0,75cm 9"x70 7/8"x1/4"	100203334 L165003957	G-230	4 x Cj 256 x Pal	1,64 x Cj 105,06 x Pal	13,66 x Cj 874,24 x Pal
Zocalo Linkfloor Empire Light Grey	8x220x1,5cm 3 1/8"x86 5/8"x5/8"	100211747 L167012923	G-121	14 x Cj 560 x Pal	2,46 x Cj 98,56 x Pal	19,32 x Cj 772,80 x Pal
Aluminium Skirting / Zócalo Aluminio / Plinthe Aluminium	8x225cm 3 1/8"x88 5/8"	100128267 L167901793	G-121	12 x Cj 696 x Pal	2,16 x Cj 125,28 x Pal	19,45 x Cj 1128,22 x Pal
Adh Profile / Perfil Adh / Profilé Adh	3,5x270cm 1 3/8"x106 1/4"	100211800 L167012922	G-155	20 x Cj 1000 x Pal	2,16 x Cj 108,00 x Pal	15,92 x Cj 796 x Pal
Aluminium Linkfloor Adh Profile / Perfil Adh Linkfloor Aluminio / Profilé Adh Linkfloor Aluminium	3,5x270cm 1 3/8"x106 1/4"	100174756 L167012669	G-121	10 x Cj 1000 x Pal	0,95 x Cj 94,50 x Pal	3,87 x Cj 387 x Pal

NEW



Linkfloor Empire Tan



NATURAL



WET



FLOATING
INSTALLATION



RADIANT
FLOOR
HEATING



LOCK



15
WARRANTY

Description	Format	Codes	Group	Pcs	m2	Kg
Linkfloor Empire Cream	22,8x180x0,75cm 9"x70 7/8"x1/4"	100203335 L165003952	G-230	4 x Cj 256 x Pal	1,64 x Cj 105,06 x Pal	13,66 x Cj 874,24 x Pal
Zocalo Linkfloor Empire Tan	8x220x1,5cm 3 1/8"x86 5/8"x5/8"	100211775 L167012925	G-121	14 x Cj 560 x Pal	2,46 x Cj 98,56 x Pal	19,32 x Cj 772,80 x Pal
Aluminium Skirting / Zócalo Aluminio / Plinthe Aluminium	8x225cm 3 1/8"x88 5/8"	100128267 L167901793	G-121	12 x Cj 696 x Pal	2,16 x Cj 125,28 x Pal	19,45 x Cj 1128,22 x Pal
Adh Profile / Perfil Adh / Profilé Adh	3,5x270cm 1 3/8"x106 1/4"	100211801 L167012926	G-155	20 x Cj 1000 x Pal	2,16 x Cj 108,00 x Pal	15,92 x Cj 796 x Pal
Aluminium Linkfloor Adh Profile / Perfil Adh Linkfloor Aluminio / Profilé Adh Linkfloor Aluminium	3,5x270cm 1 3/8"x106 1/4"	100174756 L167012669	G-121	10 x Cj 1000 x Pal	0,95 x Cj 94,50 x Pal	3,87 x Cj 387 x Pal

NEW

BEFORE INSTALLING

ANTES DE INSTALAR

AVANT DE COMMENCER LA POSE



Receiving and storage: verify the material and the installation location.

Recepción y almacenaje: verificar el material y el lugar de la instalación.

Réception et stockage : vérifier le matériel et le lieu de l'installation.

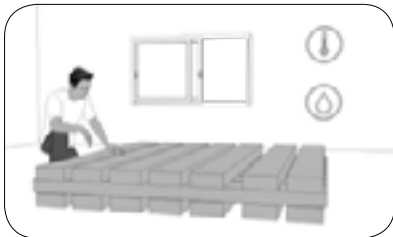

Climatic conditions: Temp. 20-23°C/65-80°F; 40-60% relative humidity.

Condiciones climáticas: T° 20-23°C/65-80°F; Humedad relativa 40-60%.

Conditions climatiques: Température: 20-23°C/65-80°F; humidité relative: 40-60%.

Substrates

Subsuelo

Sous-couches



Measure humidity with a hygrometer. Max 2.5%

Medir la humedad con higrómetro. Max 2,5%.

Mesurer l'humidité avec un hygromètre. Max 2,5%.

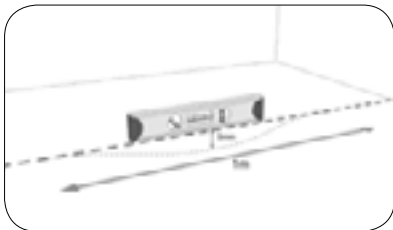

Flatness and horizontality: max. 5mm and 1mm. Measured with 2m rulers and approx. 20cm.

Planimetría y horizontalidad: max. 5mm y 1mm. Medidas con reglas de 2

y 20cm aprox.

Planimétrie et horizontalité : maximum 5mm et 1mm. Mesures avec des règles d'environ 2 et 20cm.



Cleaning: clean base slab, and free from elements.

Limpieza: solera limpia y libre de elementos.

Nettoyage lisse de terre propre et dépourvue d'éléments.



Install boards in parallel to the main light source in the room. If this is not possible, to the longer wall.

Instalar tablas en paralelo a la fuente de luz principal de la habitación. Si esto no es posible a la pared más larga.

Installer les planches parallèles à la source de lumière principale de la pièce. Si cela n'est pas possible, le faire au mur plus long.

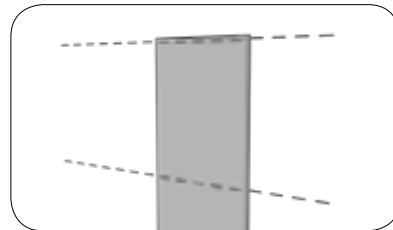

Measure out whether the boards in the first row need to be cut width-wise. If not required, trim the tongue so that the wall end is smooth.

Medir tablas de la primera fila por si tienen que cortarse a lo ancho. Si no fuese necesario, recortar la lengüeta para que el de la pared sea liso.

Mesurer les planches de la première file, pour vérifier s'il faut les couper en largeur. Si ce n'était pas nécessaire, découper la languette pour que celle du mur soit lisse.

INSTALLATION

INSTALACIÓN

POSE

Floating system

Sistema flotante

Système flottant

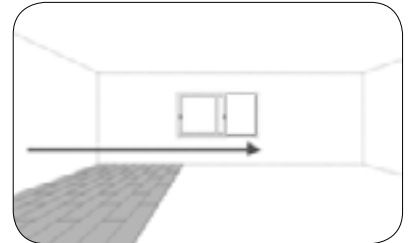

Install the boards from left to right.

Instalar las tablas desde la izquierda hacia la derecha.

Installer les planches de gauche à droite.

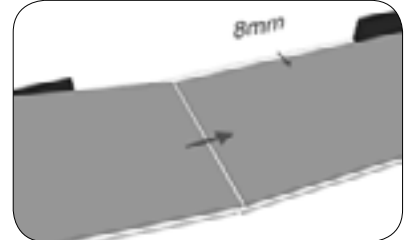

Install the second board of the first row by wrapping the short tongue in the short groove of the first board. Do not bend the board corners. Expansion gap of 8mm more or less between the board and wall.

Instalar la segunda tabla de la primera fila envolviendo la lengüeta corta en la ranura corta de la primera. No doblar las esquinas de la tabla. Ranura de expansión de unos 8mm entre tabla y pared.

Installer la deuxième planche de la première file en enveloppant la languette courte dans la rainure courte de la première planche. Ne pliez pas les coins de la planche. Rainure de dilatation d'environ 8mm entre la planche et le mur.

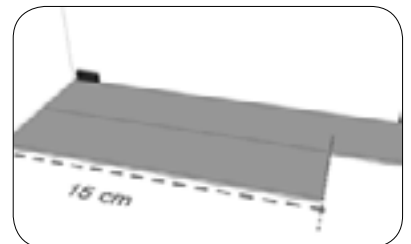

Start the second row by cutting one board to the desired length. 15cm board minimum.

Comenzar la segunda fila recortando una tabla a la medida deseada. Mínimo de la tabla 15cm.

Commencer la deuxième file en découpant une planche à la mesure souhaitée. La planche doit mesurer minimum 15cm.

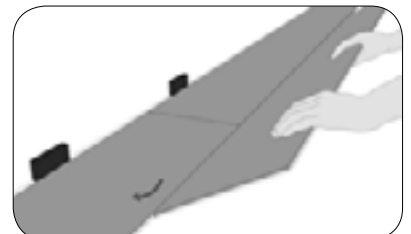

Installation / Instalación / Installation

In the second row, install the first board by wrapping the long tongue with the groove of the board from the first row at a small angle. Install the second board by joining the short tongue with the groove of the previously-installed board. Adjust the board so that the side of the long tongue is positioned over the groove of the board in the first row. Start from the last fitting, insert the long tongue in the groove of the opposite board.

En la segunda fila, instalar la primera tabla envolviendo la lengüeta larga con la ranura de la tabla de la primera fila en un ángulo pequeño. Colocar la segunda tabla uniendo la lengüeta corta con la ranura de la tabla instalada anteriormente. Ajustar la tabla de forma que el lado de la lengüeta larga esté posicionado por encima de la ranura de la tabla de la primera fila. Comenzar desde el encaje final, introducir la lengüeta larga en la ranura de la tabla de enfrente.

Dans la deuxième file, installer la première planche en enveloppant la languette longue avec la rainure de la planche de la première file dans l'angle petit. Placer la deuxième planche en unissant la languette courte avec la rainure de la planche préalablement installée. Ajuster la planche de façon à ce que la languette longue soit située au-dessus de la rainure de la planche de la première file. Commencer depuis l'emboîtement final, introduire la languette longue dans la rainure de la planche d'en face.

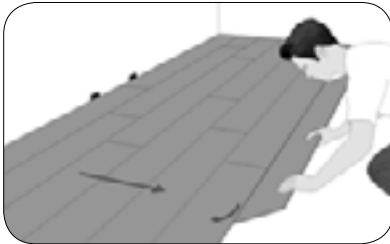

Install the remaining first and second row boards as described in the previous points.

Instalar las tablas restantes de la primera y segunda fila como se describe en los puntos anteriores.

Installer les planches restantes de la première et la deuxième file en suivant les descriptions ci-dessus.



Install the last board in the first row, leaving space to the wall for an expansion gap of about 8mm.

Instalar la última tabla de la primera

fila dejando espacio con la pared para una ranura de expansión de unos 8mm.

Installer la dernière planche de la première file en laissant un espace avec le mur pour une rainure de dilatation d'environ 8mm.



Heavy furniture can deform the surface of the pieces

El mobiliario pesado puede deformar la superficie de las piezas.

Le mobilier lourd peut déformer la surface des pièces.

Radiant floor heating

Suelo radiante

Plancher rayonnant

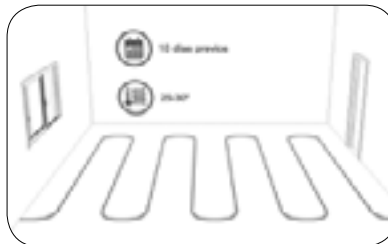

Turn on the radiant system to 25-30°C, 10 days before installing.

Encender el sistema radiante 10 días antes de la instalación a 25-30°C.

Allumer le système de chauffage rayonnant 10 jours avant l'installation à 25-30°C.



Once installed, increase the temperature by 2-3°C per day until reaching 27-28°C.

Una vez instalado incrementar la Tª 2-3°C al día hasta 27-28°C.

Après l'installation du revêtement pour le sol, augmenter la température entre 2 et 3°C chaque jour jusqu'à 27-28°C.



Once the max temperature is reached (27-28°C,) it must be maintained one day per cm of thickness of the sub-floor (overnight).

Una vez alcanzada la Tª max (27-28°C). Mantener un día por cada cm de espesor del subsuelo (por la noche).

Dès que la température maximale (27-28°C) est atteinte, la maintenir un jour pour chaque centimètre d'épaisseur du sous-sol (pendant toute la nuit).

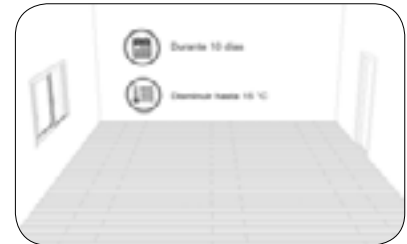

The temperature must be lowered 2-3 °C until the floor reaches 15°C (about 10 days.)

Disminuir la Tª 2-3°C hasta que el suelo alcance los 15°C (unos 10 días).

Finalemnt, diminuer la température entre 2 et 3°C jusqu'à ce que la température du sol arrive à 15°C (environ 10 jours).

You can see these updated installation instructions by visiting our website www.anticcolonial.com

Puedes revisar estas instrucciones de instalación actualizadas y con más detalle visitando nuestra página web www.anticcolonial.com

Pour réviser ces instructions d'installation, mises à jour et plus détaillées, veuillez visiter notre site Internet www.anticcolonial.com



Antistatic Underfloor Heating Layer
Lamina Suelo Radiante Antiestática
Sous-Couche Plancher Rayonnant Antistatique

25m² - 100175300 - L165003722 - G-169

A lining made of recycled closed-cell rubber with an aluminium layer that dissipates heat and eliminates static electricity. This protection can be used over underfloor heating and reduces impact noise by 26dB airborne noise by 22dB.

Lámina realizada con caucho reciclado de celda cerrada que cuenta con una capa de aluminio capaz de repartir el calor y eliminar la electricidad estática. Esta protección se puede utilizar sobre suelo radiante y reduce el sonido de impacto en 26dB y el aéreo en 22dB.

Sous-couche en caoutchouc recyclé à cellules fermées composée d'une couche d'aluminium capable de répartir la chaleur et d'éliminer l'électricité statique. Cette protection peut être utilisée sous un plancher rayonnant, elle réduit les sons d'impact de 26dB et les sons aériens de 22dB.



Sous-Couche Anti-Humidité + Mousse
Lamina Antihumedad + Espuma
Damp Proofing Sheet + Foam

22m² - 100169988 - L180112046 - G-151

140m² - 100170010 - L180112045 - G-169

Sound insulation and damp proofing for parquet and laminate flooring.

Aislante acústico y antihumedad para el parquet y el laminado.

Isolant phonique et anti-humidité pour les parquets et les planchers stratifiés.



Insulating Layer
Lamina Aislante
Sous-Couche Isolante

79x59x0,5cm - 100059778 - L180112013 - G-104

5mm-thick sound insulation useful for rectifying uneven patches.

Aislante acústico de 5 mm de grosor, útil para corregir desniveles.

Isolant phonique de 5 mm d'épaisseur, utile pour compenser des différences de niveaux.

Cleaner / Limpiador / Nettoyants



Intensive maintenance and cleaning laminate wood.

Mantenimiento laminado y limpieza intensiva de maderas.

Entretien et nettoyage intensif de bois stratifié.

Clean and Green Active 0,5 L

100148087 - L167012432 - G-128

Thinning / Dilución / Dilution 1:200
 Coverage / Rendimiento / Rendement 1500 m²/L



PORCELANOSA Grupo

www.anticcolonial.com

L'ANTIC COLONIAL



L'ANTIC COLONIAL S.A reserves the right to change and/or delete certain models shown in this catalogue without prior notice. The colours of the illustrations may vary with respect to the original pieces. The settings shown in this catalogue are decorative suggestions used for advertising purposes. The assembly instructions published by L'ANTIC COLONIAL must be observed in all real installations. The measurements listed in this catalogue are NOMINAL measurements.

L'ANTIC COLONIAL S.A se reserva el derecho de modificar y/o suprimir ciertos modelos expuestos en este catálogo sin previo aviso. Los colores de las piezas pueden presentar diferencias respecto a los originales. Los ambientes que se muestran en este catálogo son sugerencias decorativas de carácter publicitario debiéndose utilizar en la instalación real las instrucciones de colocación editadas por L'ANTIC COLONIAL. Las medidas que aparecen en este catálogo son NOMINALES.

L'ANTIC COLONIAL SA se réserve le droit de modifier et / ou supprimer certains modèles présentés dans ce catalogue sans préavis. Les couleurs des pièces peuvent différer de l'original. Les environnements présentés dans ce catalogue sont des suggestions de décoration à caractère publicitaire. Dans les conditions d'installation réelles, il est indispensable de respecter les consignes de pose édictées par L'ANTIC COLONIAL. Les mesures gurant dans ce catalogue sont nominales.

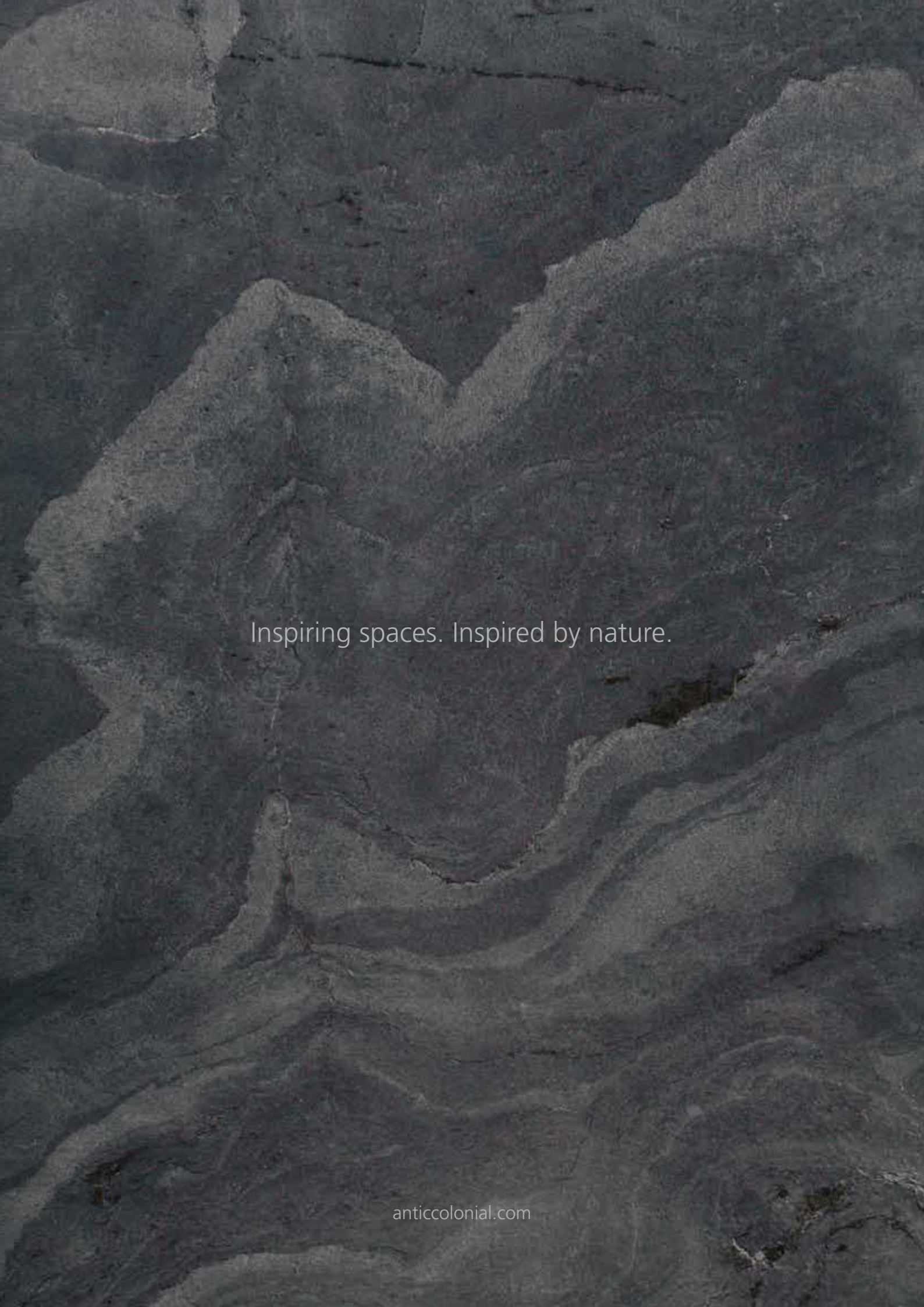

Inspiring spaces. Inspired by nature.